

*Jacuzzi*®

15.01.2024 - Euro €

Euro V.A.T. not included

INTERNATIONAL - ENG/DE

PRICE LIST  
PREISLISTE  
HOT TUB  
AND  
SWIM SPA

# INDEX REGISTER

## HOT TUB AND SWIM SPA COLLECTION

Instructions for ordering  
Hinweise zur Bestellung 3

SmartTub® 5

**new** Infrared technology: a new frontier in wellness  
Infrarot-Technologie: Die Wellness hat ein neues  
Niveau erreicht 7

## J-400™ COLLECTION

**new** J-495™ 9

**new** J-485™ 10

**new** J-475™ 11

**new** J-445™ 12

**new** J-435™ 13

## J-LX® COLLECTION

**new** J-LX® 30

**new** J-LXL® 31

## J-300™ COLLECTION

J-385™ 16

J-375™ 17

J-365™ 18

J-355™ 19

J-345™ 20

J-335™ 21

J-325™ 22

J-315™ 23

## J-200™ CLASSIC COLLECTION

J-245™ 26

J-235™ 27

## DESIGN COLLECTION

Instructions for ordering  
Hinweise zur Bestellung 34

VIRTUS 35

PROFILE 36

SANTORINI 37

DELOS 38

DELFI 39

UNIQUE 40

CITY™ SPA 41

ALIMIA 42

## LODGE+ COLLECTION

LODGE+ L 47

LODGE+ M 48

LODGE+ S 49

## PROFESSIONAL COLLECTION

VIRTUS PRO 52

ENJOY PRO 53

VIRGINIA PRO 54

SIENNA PRO 55

ALIMIA PRO 56

## SWIM SPA COLLECTION

**new** J-19 POWERPRO™ 60

**new** J-19 POWERACTIVE™ 61

**new** J-16 POWERPRO™ 62

**new** J-16 POWERACTIVE™ 63

**new** J-13 POWERPLAY™ 64

Accessories Swim Spa  
Zubehör Swim Spa 65

Outdoor shower column  
Duschsäule für Außenbereiche 66

Accessories Hot Tub  
Zubehör Hot Tub 67

Insulating cover  
Wärmeabdeckung 68

Colors, materials and finishes  
Farben, Materialien und Oberflächen 70

General terms of sale  
Allgemeine Verkaufsbedingungen 72

# COLORS, MATERIALS AND FINISHES FARBEN, MATERIALIEN UND AUSFÜHRUNGEN

Check color availability by model • Kontrollieren Sie die Verfügbarkeit der Farbe pro Modell

## SHELL COLOR · FARBEN (SCHALE)

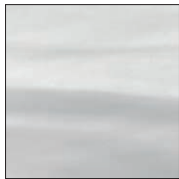

**PLATINUM**

J-400™ - J-LX® - J-300™  
- J-200™ Classic -  
DESIGN - LODGE+ -  
PROFESSIONAL  
SWIM SPA

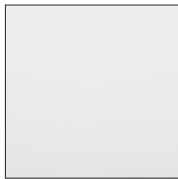

**PORCELAIN**

J-400™ - J-LX® - J-300™  
- J-200™ Classic -  
DESIGN - LODGE+ -  
PROFESSIONAL  
SWIM SPA

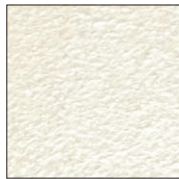

**SILVER PEARL**

J-400™ - J-300™  
SWIM SPA

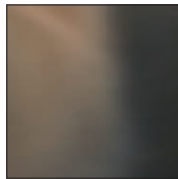

**MIDNIGHT**

J-400™ - J-300™

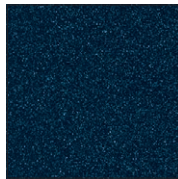

**COBALT**

DESIGN: Alimia  
PROFESSIONAL: Enjoy Pro,  
Virginia Pro, Sienna Pro,  
Alimia Pro

## CABINET COLOR · PANELAUSFÜHRUNGEN

### PROFINISH™



**BRUSHED GREY**

J-400™ - J-LX® -  
J-300™ - SWIM SPA

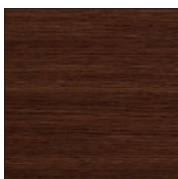

**MODERN  
HARDWOOD**

J-400™ - J-LX® -  
J-300™ - SWIM SPA



**SMOKED EBONY**

J-400™ - J-LX® -  
J-300™ - SWIM SPA

### SYNTHETIC WOOD HOLZIMITAT

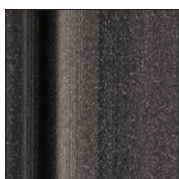

**SILVERWOOD**

J-200™ Classic  
LODGE+

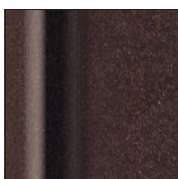

**ROASTED  
CHESTNUT**

LODGE+



**GRAPHITE**

DESIGN: Virtus, Profile,  
Santorini, Delos, Delfi,  
Alimia

### WOOD HOLZ

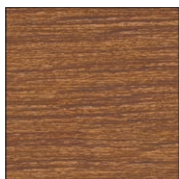

**TEAK**

DESIGN  
Virtus, Santorini,  
Delos, Delfi,

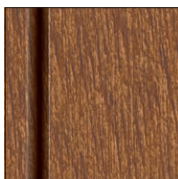

**TEAK**

DESIGN  
Profile

### COMPOSITE-PVC VERBUNDWERKSTOFF-PVC



**WHITE OAK**

DESIGN  
Unique, City™ Spa

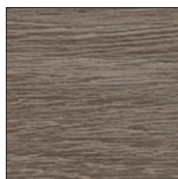

**GREY OAK**

DESIGN  
Unique, City™ Spa

## INSULATING COVER · WÄRMEABDECKUNG

### PROLAST™



**BLACK  
SCHWARZ**

J-400™ - J-LX® -  
J-300™ - J-200™ Classic

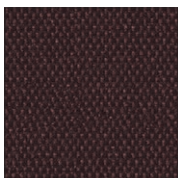

**BROWN  
BRAUN**

SWIM SPA



**GREY  
GRAU**

SWIM SPA

### PROVINYL



**ICE**

DESIGN  
PROFESSIONAL



**GREY  
GRAU**

LODGE +

### ROLLAWAY®



**CHARCOAL GREY  
ANTHRAZITGRAU**

SWIM SPA







## INSTRUCTIONS FOR ORDERING

Dimensions and descriptions are indicated in the master brochure and in this price list.

Orders must include:

- a) name** J-435™
- b) spa code** YV12RU0EWMT
- c) cover code** 903003420

NOTE: Optional and accessories marked with dedicated codes to be ordered separately are not included or installed on the product.

---

## HINWEISE ZUR BESTELLUNG

Zur Beschreibung und für die Abmessungen, sollte man sich auf den Katalog und die Preisliste beziehen.

Die Bestellungen sollten folgendes beinhalten:

- a) Name** J-435™
- b) Artikel-Nr.** YV12RU0EWMT
- c) Wärmeabdeckung-Nr.** 903003420

NOTE: Optional und accessoires, die mit entsprechenden Codes gekennzeichnet sind, die separat bestellt werden müssen, sind nicht im Produkt inbegriffen oder installiert.

---



**DO NOT USE SEA WATER OR WATER WITH ADDED SALT ON ALL HOT TUB AND SWIM SPA MODELS.**

**ALLE HOT TUB- UND SWIM SPA-MODELLE NICHT MIT MEERWASSER ODER MIT ZUGESETZTEM SALZ VERWENDEN.**

***Jacuzzi***<sup>®</sup>

# SmartTub®

**NEW!** Increase safety and savings when using your Hot tub with Wireless Sensors.

**NEU!** Größere Sicherheit und Ersparnis bei der Nutzung des Spas mit Wireless-Sensoren.

## SIMPLIFIED HOT TUB OWNERSHIP

The exclusive SmartTub® system is engineered to maximize your relaxation, recovery, and energysaving potential.

### • NEW

Increase safety and savings with Wireless Sensors for monitoring heat coverage, Hot tub fill level and internal condensation

- Stable, secure, cellular connection
- Easy setup, no WiFi credential needed
- Updates made seamlessly over the air
- Remote monitoring
- Reminders
- Power outage notification
- Energy usage estimator\*
- Personalized use and care content
- Includes 1 year data plan, \$36/yr after\*\*

• Compatible with Android, iOS, Alexa, iPad, Apple Watch and Google Assistant

## EINFACHER BESITZ VON WHIRLPOOLS

Patentierte und exklusive Technologie, die sich darauf konzentriert, das absolut beste Erlebnis für den Verbraucher zu bieten.

### • NEU

Größere Sicherheit und Ersparnis bei der Nutzung des Spas mit den Wireless-Sensoren für die Kontrolle von Thermodecke, Füllstand und interner Kondensatbildung

- Stabile, sichere und Mobilfunkverbindung
- Einfache Einrichtung, keine WiFi-Anmeldung erforderlich
- Nahtlose Updates über das Internet
- System lernt nutzungs basiert
- Enthält einen 1-Jahres-Datenplan, 36 USD/Jahr\* nach dem Kauf
- Fernüberwachung und Alarme
- Erinnerungen
- Benachrichtigung bei Stromausfall
- Energieverbrauchskalkulator\* \*
- Personalisierte Nutzungs- und Pflegeinhalte

• Kompatibel mit Android, iOS, Alexa, iPad, Apple Watch und Google Assistant



Learn more about SmartTub® Technology by visiting [www.jacuzzi.com](http://www.jacuzzi.com)

Erfahren Sie mehr über die SmartTub® Technology unter [www.jacuzzi.com](http://www.jacuzzi.com)

SmartTub® system uses cellular-based communication and requires cell service from our provider partner in your area. See website for details.

\* Estimates are based on sensor readings and are not meant to match your utility measurements, see your local utility company for specifics.

\*\* Requires subscription beginning in second year of ownership.

Das SmartTub®-System nutzt Mobilfunkkommunikation und benötigt einen Mobilfunkdienst unseres Provider-Partners in Ihrer Nähe. Einzelheiten dazu finden Sie auf der Website.

\* Erfordert ein Abonnement ab dem zweiten Jahr des Besitzes.

\*\* Schätzungen basieren auf Sensormesswerten und sind nicht dazu bestimmt, mit Ihren Versorgungsmessungen übereinzustimmen, informieren Sie sich bei Ihrem örtlichen Versorgungsunternehmen.



## Infrared technology: a new frontier in wellness

Jacuzzi® is the first and only brand to offer Infrared and Red Light therapy across a range of wellness products, from Hot Tubs to Swim Spas.

Premiering in the **J-LX® and J-400™ Collection**, the FX-IR Seat combines Infrared and Red Light therapy with hydromassage for unmatched rejuvenation.

### The therapeutic benefits of hydrotherapy

— The regeneration power of Infrared and Red Light

— The regenerative qualities of Infrared and Red Light

— All working together deep beneath the skin's surface

## Infrarot-Technologie: Die Wellness hat ein neues Niveau erreicht

Jacuzzi® hat als erster und bisher einziger Hersteller die Infrarot-Technologie in Wellness-Produkte vom Hot Tub bis zum Swim Spa integriert. Der erstmals mit **den Kollektionen J-LX® und J-400™** präsentierte Sitz FX-IR vereint Hydromassage mit Infrarot-Technologie und erzeugt so eine unübertreffliche, verjüngende Wirkung.

— Die wohltuende Wirkung der Hydrotherapie

— Die kräftigende Wirkung der Infrarotstrahlen

— Die regenerierende Wirkung der Infrarot-Technologie

— Kombinierte Tiefenwirkung bis unter die Haut

### Rejuvenation Meets Relaxation

The rejuvenating powers of Infrared and Red Light therapy work together deep beneath the skin's surface to relieve pain, improve range of motion, and reach a state of mindfulness.

### Effortless

Only Jacuzzi® offers the joys and benefits of hydrotherapy, Infrared and Red Light therapy, effortlessly ready when you are.

### Peace of Mind

You can be confident using IR and Red Light therapy to enhance your relaxation.

### Energie und Entspannung

Die stärkenden Eigenschaften der Infrarot-Technologie wirken gemeinsam unter der Oberfläche und in den tieferen Schichten der Haut. Das lindert Schmerzen, verbessert die Beweglichkeit und trägt dazu bei, wieder in Einklang mit sich selbst zu kommen.

### Einfach

Nur Jacuzzi® bietet den Genuss einer wohltuenden Hydrotherapie und der Infrarot-Technologie jederzeit und auf überraschend einfache Weise.

### Entspannend

Die Infrarot-Technologie steigert die Entspannung und bietet vollkommene Sicherheit.



FX-IR Therapy Seat

Therapeutischer Sitz FX-IR

Skin Level / Hauttiefe

|  |   |  |
|--|---|--|
|  | <b>Hydromassage</b><br>Jet pressure delivers varied massage through surface contact                 | <b>Hydromassage</b> Der Düsendruck wirkt über den gesamten Kontaktbereich wie eine differenzierte Massage.             |
|  | <b>Red Light</b><br>Specialized deep red light reaches surface tissue and cells                     | <b>Rotlicht</b> Hochintensives, entsprechend regulierte Rotlicht erreicht das Gewebe und die Zellen an der Oberfläche. |
|  | <b>Near Infrared</b><br>Positioned to target deep tissue within the lumbar region of the lower back | <b>Nah-Infrarotlicht</b><br>Das Infrarotlicht wird auf das Bindegewebe der Lumbal- und Rückenregion gerichtet.         |





*Jacuzzi*®



*Jacuzzi*®

SmartTub®

J-400™ COLLECTION



J-485™



**J-495™** LOUNGE  
Design Jacuzzi®

SmartTub®

231 x 279 x 95/110 H cm

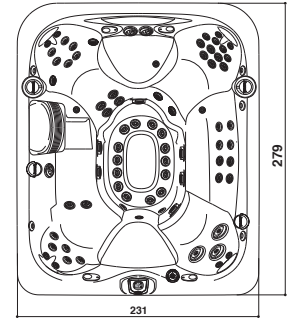

FEATURES • VERSIONEN

|  |  | FREESTANDING   |
|--|--|----------------|
|  | Seats (total)<br>Sitzflächen (insgesamt)   | <b>8 - 9</b>   |
|  | Lounge   | <b>1 pivot</b> |
|  | Jets<br>Düsen  | <b>69</b>      |
|  | IR and Red Lights<br>Infrarotlampen und rotes Licht  | <b>2</b>       |
|  | WaterColour™ Waterfall<br>WaterColour™ Wasserfall  | <b>1</b>       |
|  | Underwater LED multicolor light<br>Mehrfarbige Unterwasser-LED-Leuchte                                     | ✓              |
|  | Adjustable headrest<br>Einstellbare Kopfstütze   | <b>4</b>       |
|  | ProTouch™ control panel<br>Kontrollanzeige ProTouch™   | ✓              |
|  | External corner lighting<br>Außenecken-Beleuchtung   | ✓              |
|  | Status indicator light<br>Funktionsanzeige   | ✓              |
|  | CLEARRAY Active Oxygen™<br>Low output ozone generator + UV-C<br>Ozongenerator mit geringer Emission + UV-C | ✓              |
|  | Quick drain<br>Schnelle Entleerung   | ✓              |

| SKIRTING • PANEELE |   | ProFinish™ | FINISHING<br>AUSFÜHRUNGEN | BRUSHED<br>GREY | MODERN<br>HARDWOOD | SMOKED<br>EBONY |
|--------------------|---|------------|---------------------------|-----------------|--------------------|-----------------|
|                    | Bluewave™ Stereo System<br>(Wireless + AUX) | ProFinish™ | Platinum                  | YR12RU0EWM T    | YR12RD0EWM T       | YR12RY0EWM T    |
|                    |   |            | Silver Pearl              | YR33RU0EWM T    | YR33RD0EWM T       | YR33RY0EWM T    |
|                    |   |            | Midnight                  | YR62RU0EWM T    | YR62RD0EWM T       | YR62RY0EWM T    |
|                    |   |            | Porcelain                 | YR76RU0EWM T    | YR76RD0EWM T       | YR76RY0EWM T    |
|                    |   |            |                           | <b>€ 36.547</b> |                    |                 |
|                    | Without Stereo System<br>Ohne Stereo System |            | Platinum                  | YJ12RU0EWM T    | YJ12RD0EWM T       | YJ12RY0EWM T    |
|                    |   |            | Silver Pearl              | YJ33RU0EWM T    | YJ33RD0EWM T       | YJ33RY0EWM T    |
|                    |   |            | Midnight                  | YJ62RU0EWM T    | YJ62RD0EWM T       | YJ62RY0EWM T    |
|                    |   |            | Porcelain                 | YJ76RU0EWM T    | YJ76RD0EWM T       | YJ76RY0EWM T    |
|                    |   |            |                           | <b>€ 33.084</b> |                    |                 |

INSULATING COVER to be included in the order • WÄRMEABDECKUNG Muss im Auftrag enthalten sein

|  |          |                  |                |
|--|----------|------------------|----------------|
|  | PROLAST™ | Black<br>Schwarz | 903003260      |
|  |          |                  | <b>€ 2.004</b> |

ACCESSOIRES • ZUBEHÖRE

|  |            |   |              |
|--|------------|---|--------------|
|  | SmartTub®  | Three-phase upgrade kit<br>Dreiphasen-Adapter-Kit                       | 919405320    |
|  |            |   | <b>€ 380</b> |
|  | SmartTub®  | Wireless Sensor Kit<br>Kit Wireless-Sensoren SmartTub®                  | 919405450    |
|  |            |   | <b>€ 560</b> |
|  | VersaStep™ | Stufe VersaStep™  | 890011360    |
|  |            |   | <b>€ 602</b> |
|  | J-495™     | Cover lifter hydraulic assist<br>Hydraulischer Heber für Wärmeabdeckung | 890011520    |
|  |            |   | <b>€ 865</b> |





**J-485™**  
Design Jacuzzi®



231 x 231 x 95/110 H cm

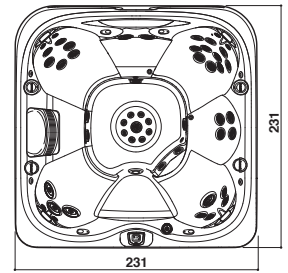

**FEATURES • VERSIONEN**

|  |  | FREESTANDING |
|--|--|--------------|
|  | Seats (total)<br>Sitzflächen (insgesamt)   | <b>6-7</b>   |
|  | Lounge   | --           |
|  | Jets<br>Düsen  | <b>47</b>    |
|  | IR and Red Lights<br>Infrarotlampen und rotes Licht  | <b>2</b>     |
|  | WaterColour™ Waterfall<br>WaterColour™ Wasserfall  | <b>1</b>     |
|  | Underwater LED multicolor light<br>Mehrfarbige Unterwasser-LED-Leuchte                                     | ✓            |
|  | Adjustable headrest<br>Einstellbare Kopfstütze   | <b>4</b>     |
|  | ProTouch™ control panel<br>Kontrollanzeige ProTouch™   | ✓            |
|  | External corner lighting<br>Außenecken-Beleuchtung   | ✓            |
|  | Status indicator light<br>Funktionsanzeige   | ✓            |
|  | CLEARRAY Active Oxygen™<br>Low output ozone generator + UV-C<br>Ozongenerator mit geringer Emission + UV-C | ✓            |
|  | Quick drain<br>Quick drain (Schnelle Entleerung)   | ✓            |

| SKIRTING • PANEELE |   | ProFinish™   | FINISHING<br>AUSFÜHRUNGEN | BRUSHED<br>GREY | MODERN<br>HARDWOOD                          | SMOKED<br>EBONY |
|--------------------|---|--------------|---------------------------|-----------------|---|-----------------|
|                    |   |              |                           |                 | Bluewave™ Stereo System<br>(Wireless + AUX) | Platinum        |
|                    |   | Silver Pearl | Y633RU0EWMPT              | Y633RD0EWMPT    | Y633RY0EWMPT                                |                 |
|                    |   | Midnight     | Y662RU0EWMPT              | Y662RD0EWMPT    | Y662RY0EWMPT                                |                 |
|                    |   | Porcelain    | Y676RU0EWMPT              | Y676RD0EWMPT    | Y676RY0EWMPT                                |                 |
|                    |   |              |                           | <b>€ 33.610</b> |   |                 |
|                    | Without Stereo System<br>Ohne Stereo System | Platinum     | Y512RU0EWMPT              | Y512RD0EWMPT    | Y512RY0EWMPT                                |                 |
|                    |   | Silver Pearl | Y533RU0EWMPT              | Y533RD0EWMPT    | Y533RY0EWMPT                                |                 |
|                    |   | Midnight     | Y562RU0EWMPT              | Y562RD0EWMPT    | Y562RY0EWMPT                                |                 |
|                    |   | Porcelain    | Y576RU0EWMPT              | Y576RD0EWMPT    | Y576RY0EWMPT                                |                 |
|                    |   |              |                           | <b>€ 30.304</b> |   |                 |

**INSULATING COVER to be included in the order • WÄRMEABDECKUNG Muss im Auftrag enthalten sein**

|  |          |                  |                |
|--|----------|------------------|----------------|
|  | PROLAST™ | Black<br>Schwarz | 903003330      |
|  |          |                  | <b>€ 1.475</b> |

**ACCESSOIRES • ZUBEHÖRE**

|  |            |   |              |              |
|--|------------|---|--------------|--------------|
|  | SmartTub®  | Three-phase upgrade kit<br>Dreiphasen-Adapter-Kit                       | 919405320    |              |
|  |            |   | <b>€ 380</b> |              |
|  | SmartTub®  | Wireless Sensor Kit<br>Kit Wireless-Sensoren SmartTub®                  | 919405450    |              |
|  |            |   | <b>€ 560</b> |              |
|  | VersaStep™ | Stufe VersaStep™  | 890011360    |              |
|  |            |   | 890011350    |              |
|  |            |   | 890011370    |              |
|  |            |   |              | <b>€ 602</b> |
|  | J-400™     | Cover lifter hydraulic assist<br>Hydraulischer Heber für Wärmeabdeckung | 890011510    |              |
|  |            |   |              | <b>€ 865</b> |





**J-475™**  
Design Jacuzzi®







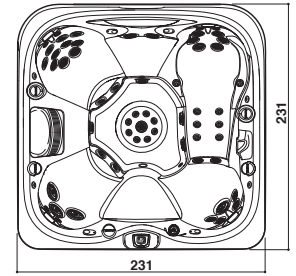









 SmartTub®

231 x 231 x 95/110 H cm



FEATURES • VERSIONEN





|   |  | FREESTANDING |
|---|--|--------------|
|    | Seats (total)<br>Sitzflächen (insgesamt)   | <b>6-7</b>   |
|    | Lounge   | <b>1</b>     |
|    | Jets<br>Düsen  | <b>53</b>    |
| <span style="background-color: #008080; color: white; padding: 2px;">new</span>  | IR and Red Lights<br>Infrarotlampen und rotes Licht  | <b>2</b>     |
|    | WaterColour™ Waterfall<br>WaterColour™ Wasserfall  | <b>1</b>     |
|   | Underwater LED multicolor light<br>Mehrfarbige Unterwasser-LED-Leuchte                                     | ✓            |
|    | Adjustable headrest<br>Einstellbare Kopfstütze   | <b>4</b>     |
|    | ProTouch™ control panel<br>Kontrollanzeige ProTouch™   | ✓            |
|    | External corner lighting<br>Außenecken-Beleuchtung   | ✓            |
|    | Status indicator light<br>Funktionsanzeige   | ✓            |
|    | CLEARRAY Active Oxygen™<br>Low output ozone generator + UV-C<br>Ozongenerator mit geringer Emission + UV-C | ✓            |
|    | Quick drain<br>Quick drain (Schnelle Entleerung)   | ✓            |

| SKIRTING • PANEEL   |   | ProFinish™ | FINISHING<br>AUSFÜHRUNGEN | BRUSHED<br>GREY | MODERN<br>HARDWOOD | SMOKED<br>EBONY |
|---|---|------------|---------------------------|-----------------|--------------------|-----------------|
|  | Bluewave™ Stereo System<br>(Wireless + AUX) |            | Platinum                  | Y412RU0EWMT     | Y412RD0EWMT        | Y412RY0EWMT     |
|   |   |            | Silver Pearl              | Y433RU0EWMT     | Y433RD0EWMT        | Y433RY0EWMT     |
|   |   |            | Midnight                  | Y462RU0EWMT     | Y462RD0EWMT        | Y462RY0EWMT     |
|   |   |            | Porcelain                 | Y476RU0EWMT     | Y476RD0EWMT        | Y476RY0EWMT     |
|   |   |            |                           | <b>€ 33.610</b> |                    |                 |
|  | Without Stereo System<br>Ohne Stereo System |            | Platinum                  | Y312RU0EWMT     | Y312RD0EWMT        | Y312RY0EWMT     |
|   |   |            | Silver Pearl              | Y333RU0EWMT     | Y333RD0EWMT        | Y333RY0EWMT     |
|   |   |            | Midnight                  | Y362RU0EWMT     | Y362RD0EWMT        | Y362RY0EWMT     |
|   |   |            | Porcelain                 | Y376RU0EWMT     | Y376RD0EWMT        | Y376RY0EWMT     |
|   |   |            |                           | <b>€ 30.304</b> |                    |                 |

INSULATING COVER **to be included in the order** • WÄRMEABDECKUNG **Muss im Auftrag enthalten sein**

|   |          |                  |                |
|---|----------|------------------|----------------|
|  | PROLAST™ | Black<br>Schwarz | 903003330      |
|   |          |                  | <b>€ 1.475</b> |

ACCESSOIRES • ZUBEHÖRE

|   |            |   |              |
|---|------------|---|--------------|
|    | SmartTub®  | Three-phase upgrade kit<br>Dreiphasen-Adapter-Kit                       | 919405320    |
|   |            |   | <b>€ 380</b> |
| <span style="background-color: #008080; color: white; padding: 2px;">new</span>  | SmartTub®  | Wireless Sensor Kit<br>Kit Wireless-Sensoren SmartTub®                  | 919405450    |
|   |            |   | <b>€ 560</b> |
|    | VersaStep™ | Stufe VersaStep™  | 890011360    |
|   |            |   | <b>€ 602</b> |
|    | J-400™     | Cover lifter hydraulic assist<br>Hydraulischer Heber für Wärmeabdeckung | 890011510    |
|   |            |   | <b>€ 865</b> |



**J-445™**  
Design Jacuzzi®



214 x 214 x 95/110 H cm

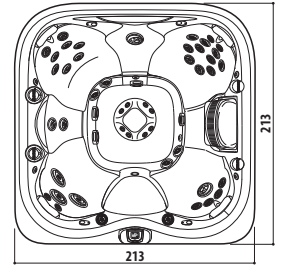

FEATURES • VERSIONEN

|  |  | FREESTANDING |  |  |
|--|--|--------------|--|--|
|  | Seats (total)<br>Sitzflächen (insgesamt)   | 6            |  |  |
|  | Lounge   | --           |  |  |
|  | Jets<br>Düsen  | 43           |  |  |
|  | IR and Red Lights<br>Infrarotlampen und rotes Licht  | 2            |  |  |
|  | WaterColour™ Waterfall<br>WaterColour™ Wasserfall  | 1            |  |  |
|  | Underwater LED multicolor light<br>Mehrfarbige Unterwasser-LED-Leuchte                                     | ✓            |  |  |
|  | Adjustable headrest<br>Einstellbare Kopfstütze   | 4            |  |  |
|  | ProTouch™ control panel<br>Kontrollanzeige ProTouch™   | ✓            |  |  |
|  | External corner lighting<br>Außenecken-Beleuchtung   | ✓            |  |  |
|  | Status indicator light<br>Funktionsanzeige   | ✓            |  |  |
|  | CLEARRAY Active Oxygen™<br>Low output ozone generator + UV-C<br>Ozongenerator mit geringer Emission + UV-C | ✓            |  |  |
|  | Quick drain<br>Quick drain (Schnelle Entleerung)   | ✓            |  |  |

| SKIRTING • PANEELE |   | ProFinish™ | FINISHING • AUSFÜHRUNGEN | BRUSHED GREY | MODERN HARDWOOD | SMOKED EBONY |
|--------------------|---|------------|--------------------------|--------------|-----------------|--------------|
|                    | Bluewave™ Stereo System<br>(Wireless + AUX) | ProFinish™ | Platinum                 | Y212RU0EWM T | Y212RD0EWM T    | Y212RY0EWM T |
|                    |   |            | Silver Pearl             | Y233RU0EWM T | Y233RD0EWM T    | Y233RY0EWM T |
|                    |   |            | Midnight                 | Y262RU0EWM T | Y262RD0EWM T    | Y262RY0EWM T |
|                    |   |            | Porcelain                | Y276RU0EWM T | Y276RD0EWM T    | Y276RY0EWM T |
|                    |   |            |                          | € 29.060     |                 |              |
|                    | Without Stereo System<br>Ohne Stereo System | ProFinish™ | Platinum                 | Y112RU0EWM T | Y112RD0EWM T    | Y112RY0EWM T |
|                    |   |            | Silver Pearl             | Y133RU0EWM T | Y133RD0EWM T    | Y133RY0EWM T |
|                    |   |            | Midnight                 | Y162RU0EWM T | Y162RD0EWM T    | Y162RY0EWM T |
|                    |   |            | Porcelain                | Y176RU0EWM T | Y176RD0EWM T    | Y176RY0EWM T |
|                    |   |            |                          | € 26.049     |                 |              |

INSULATING COVER to be included in the order • WÄRMEABDECKUNG Muss im Auftrag enthalten sein

|  |          |                  |           |
|--|----------|------------------|-----------|
|  | PROLAST™ | Black<br>Schwarz | 903003420 |
|  |          |                  | € 1.386   |

ACCESSOIRES • ZUBEHÖRE

|  |            |   |           |
|--|------------|---|-----------|
|  | SmartTub®  | Three-phase upgrade kit<br>Dreiphasen-Adapter-Kit                       | 919405320 |
|  |            |   | € 380     |
|  | SmartTub®  | Wireless Sensor Kit<br>Kit Wireless-Sensoren SmartTub®                  | 919405450 |
|  |            |   | € 560     |
|  | VersaStep™ | Stufe VersaStep™  | 890011360 |
|  |            |   | € 602     |
|  | J-400™     | Cover lifter hydraulic assist<br>Hydraulischer Heber für Wärmeabdeckung | 890011510 |
|  |            |   | € 865     |



**J-435™** LOUNGE  
Design Jacuzzi®

SmartTub®

214 x 214 x 95/110 H cm

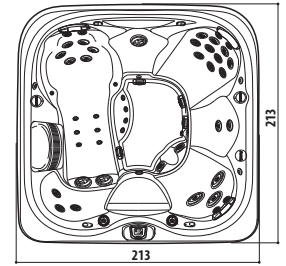

FEATURES • VERSIONEN

|  |  | FREESTANDING |  |  |
|--|--|--------------|--|--|
|  | Seats (total)<br>Sitzflächen (insgesamt)   | 5-6          |  |  |
|  | Lounge   | 1            |  |  |
|  | Jets<br>Düsen  | 45           |  |  |
|  | IR and Red Lights<br>Infrarotlampen und rotes Licht  | 2            |  |  |
|  | WaterColour™ Waterfall<br>WaterColour™ Wasserfall  | 1            |  |  |
|  | Underwater LED multicolor light<br>Mehrfarbige Unterwasser-LED-Leuchte                                     | ✓            |  |  |
|  | Adjustable headrest<br>Einstellbare Kopfstütze   | 3            |  |  |
|  | ProTouch™ control panel<br>Kontrollanzeige ProTouch™   | ✓            |  |  |
|  | External corner lighting<br>Außenecken-Beleuchtung   | ✓            |  |  |
|  | Status indicator light<br>Funktionsanzeige   | ✓            |  |  |
|  | CLEARRAY Active Oxygen™<br>Low output ozone generator + UV-C<br>Ozongenerator mit geringer Emission + UV-C | ✓            |  |  |
|  | Quick drain<br>Quick drain (Schnelle Entleerung)   | ✓            |  |  |

| SKIRTING • PANEELE |   | ProFinish™ | FINISHING • AUSFÜHRUNGEN | BRUSHED GREY | MODERN HARDWOOD | SMOKED EBONY |
|--------------------|---|------------|--------------------------|--------------|-----------------|--------------|
|                    | Bluewave™ Stereo System<br>(Wireless + AUX) |            | Platinum                 | YV12RU0EWM T | YV12RD0EWM T    | YV12RY0EWM T |
|                    |   |            | Silver Pearl             | YV33RU0EWM T | YV33RD0EWM T    | YV33RY0EWM T |
|                    |   |            | Midnight                 | YV62RU0EWM T | YV62RD0EWM T    | YV62RY0EWM T |
|                    |   |            | Porcelain                | YV76RU0EWM T | YV76RD0EWM T    | YV76RY0EWM T |
|                    |   |            |                          | € 29.060     |                 |              |
|                    | Without Stereo System<br>Ohne Stereo System |            | Platinum                 | YU12RU0EWM T | YU12RD0EWM T    | YU12RY0EWM T |
|                    |   |            | Silver Pearl             | YU33RU0EWM T | YU33RD0EWM T    | YU33RY0EWM T |
|                    |   |            | Midnight                 | YU62RU0EWM T | YU62RD0EWM T    | YU62RY0EWM T |
|                    |   |            | Porcelain                | YU76RU0EWM T | YU76RD0EWM T    | YU76RY0EWM T |
|                    |   |            |                          | € 26.049     |                 |              |

INSULATING COVER to be included in the order • WÄRMEABDECKUNG Muss im Auftrag enthalten sein

|  |          |                  |           |
|--|----------|------------------|-----------|
|  | PROLAST™ | Black<br>Schwarz | 903003420 |
|  |          |                  | € 1.386   |

ACCESSOIRES • ZUBEHÖRE

|  |            |   |           |
|--|------------|---|-----------|
|  | SmartTub®  | Three-phase upgrade kit<br>Dreiphasen-Adapter-Kit                       | 919405320 |
|  |            |   | € 380     |
|  | SmartTub®  | Wireless Sensor Kit<br>Kit Wireless-Sensoren SmartTub®                  | 919405450 |
|  |            |   | € 560     |
|  | VersaStep™ | Stufe VersaStep™  | 890011360 |
|  |            |   | € 602     |
|  | J-400™     | Cover lifter hydraulic assist<br>Hydraulischer Heber für Wärmeabdeckung | 890011510 |
|  |            |   | € 865     |



*Jacuzzi*®





J-LX® COLLECTION





**J-LX®**  
Design Jacuzzi®



231 x 231 x 86 H cm

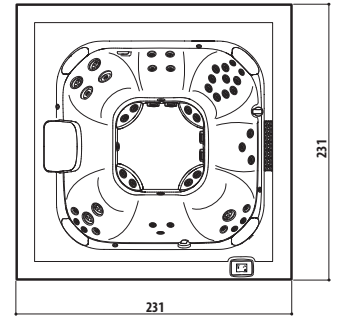

**FEATURES • VERSIONEN**

|                           |   | FREESTANDING              |                     |                        |                     |
|---------------------------|---|---------------------------|---------------------|------------------------|---------------------|
|                           | Seats (total) • Sitzflächen (insgesamt)   | 6-7                       |                     |                        |                     |
|                           | Lounge seat • Lounge Sitzfläche   | - -                       |                     |                        |                     |
|                           | Jets • Düsen  | 49                        |                     |                        |                     |
| <b>new</b>                | IR and Red Lights • Infrarotlampen und rotes Licht  | 2                         |                     |                        |                     |
|                           | Individual Seat Air Control • Individuelle Kontrolle der Luft über den Sitzflächen  | 4                         |                     |                        |                     |
| <b>new</b>                | Illuminated Infinity Edge Waterfall • Beleuchteter Wasserfall mit Überlaufwasser  | 1                         |                     |                        |                     |
| <b>new</b>                | Headrests • Kopfstütze  | 4                         |                     |                        |                     |
|                           | 5-Stage Filtration System • 5-stufiges Wasserfiltersystem   | ✓                         |                     |                        |                     |
|                           | ProClear® Filter • ProClear® Filter   | ✓                         |                     |                        |                     |
|                           | CLEARRAY® Active Oxygen® System Low output ozone generator + UV-C<br>CLEARRAY® Active Oxygen® System Ozongenerator mit geringer Emission + UV-C | ✓                         |                     |                        |                     |
|                           | CLEARRAY® On-demand button • auf Anfrage (mit entsprechendem Druckknopf)  | ✓                         |                     |                        |                     |
|                           | ProStream™ Filtration Pump • Filterpumpe ProStream™   | ✓                         |                     |                        |                     |
|                           | Floating Propolymer Foundation • Schwimmende Propylen-Basis   | ✓                         |                     |                        |                     |
|                           | Energy efficient with multi-layer insulation • Energieeffizienz mit Mehrschichtisolierung   | ✓                         |                     |                        |                     |
|                           | Tool-Free Cabinetry • Paneel mit einfacher Öffnung (kein Werkzeug erforderlich)   | ✓                         |                     |                        |                     |
|                           | Interior Dual multicolor LED Lighting • Mehrfarbige, doppelte LED-Innenbeleuchtung  | ✓                         |                     |                        |                     |
|                           | Exterior Corner White LED Lighting • Weiße, äußere LED-Eckleuchten  | ✓                         |                     |                        |                     |
|                           | SmartTub® System  | ✓                         |                     |                        |                     |
|                           | ProTouch™ Touch Screen Controls • Kontrollanzeige ProTouch™   | ✓                         |                     |                        |                     |
|                           | Quick Drain System • Quick drain (Schnelle Entleerung)  | ✓                         |                     |                        |                     |
|                           | ProLast™ Last • Wärmeabdeckung ProLast™   | Black • Schwarz           |                     |                        |                     |
| <b>SKIRTING • PANEELE</b> | ProFinish™<br>Without Stereo System<br>Ohne Stereo System   | FINISHING<br>AUSFÜHRUNGEN | <b>BRUSHED GRAY</b> | <b>MODERN HARDWOOD</b> | <b>SMOKED EBONY</b> |
|                           |   | Platinum                  | YY12RU0EMT          | YY12RD0EMT             | YY12RY0EMT          |
|                           |   | Porcelain                 | YY76RU0EMT          | YY76RD0EMT             | YY76RY0EMT          |
| <b>€ 25.700</b>           |   |                           |                     |                        |                     |

**INSULATING COVER to be included in the order • WÄRMEABDECKUNG Muss im Auftrag enthalten sein**

|  |          |                 |                |
|--|----------|-----------------|----------------|
|  | PROLAST™ | Black • Schwarz | 903003950      |
|  |          |                 | <b>€ 1.500</b> |

**ACCESSOIRES • ZUBEHÖRE**

|            |   |            |                        |
|------------|---|------------|------------------------|
|            | SmartTub® Three-phase Upgrade Kit • Dreiphasen-Adapter-Kit                                  |            | 919405320              |
|            |   |            | <b>€ 380</b>           |
| <b>new</b> | SmartTub® Wireless Sensor Kit • Kit Wireless-Sensoren SmartTub®                             |            | 919405450              |
|            |   |            | <b>€ 560</b>           |
|            | VersaStep™ • Stufe VersaStep™   | ProFinish® | <b>BRUSHED GRAY</b>    |
|            |   |            | 890011360              |
|            |   |            | <b>MODERN HARDWOOD</b> |
|            |   |            | 890011350              |
|            |   |            | <b>SMOKED EBONY</b>    |
|            |   |            | 890011370              |
|            |   |            | <b>€ 602</b>           |
| <b>new</b> | Cover lifter manual drop-behind<br>Manueller Lift für Wärmeabdeckung (hinter dem Whirlpool) |            | 890011440              |
|            |   |            | <b>€ 1.310</b>         |
|            | Cover lifter manual • Manueller Lift für Wärmeabdeckung                                     |            | 890011450              |
|            |   |            | <b>€ 541</b>           |
|            | Cover lifter hydraulic assist • Hydraulischer Heber für Wärmeabdeckung                      |            | 890011460              |
|            |   |            | <b>€ 757</b>           |





**J-LXL®**  
Design Jacuzzi®



**SmartTub®**

231 x 231 x 86 H cm

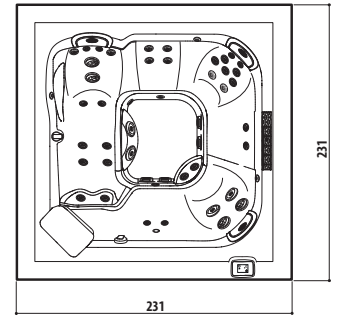

**FEATURES • VERSIONEN**

|                           |   | FREESTANDING        |                        |                     |
|---------------------------|---|---------------------|------------------------|---------------------|
|                           | Seats (total) • Sitzflächen (insgesamt)   | 5-6                 |                        |                     |
|                           | Lounge seat • Lounge Sitzfläche   | 1                   |                        |                     |
|                           | Jets • Düsen  | 45                  |                        |                     |
| <b>new</b>                | IR and Red Lights • Infrarotlampen und rotes Licht  | 2                   |                        |                     |
|                           | Individual Seat Air Control • Individuelle Kontrolle der Luft über den Sitzflächen  | 3                   |                        |                     |
| <b>new</b>                | Illuminated Infinity Edge Waterfall • Beleuchteter Wasserfall mit Überlaufwasser  | 1                   |                        |                     |
| <b>new</b>                | Headrests • Kopfstütze  | 3                   |                        |                     |
|                           | 5-Stage Filtration System • 5-stufiges Wasserfiltersystem   | ✓                   |                        |                     |
|                           | ProClear® Filter • ProClear® Filter   | ✓                   |                        |                     |
|                           | CLEARRAY® Active Oxygen® System Low output ozone generator + UV-C<br>CLEARRAY® Active Oxygen® System Ozongenerator mit geringer Emission + UV-C | ✓                   |                        |                     |
|                           | CLEARRAY® On-demand button • auf Anfrage (mit entsprechendem Druckknopf)  | ✓                   |                        |                     |
|                           | ProStream™ Filtration Pump • Filterpumpe ProStream™   | ✓                   |                        |                     |
|                           | Floating Propolymer Foundation • Schwimmende Propylen-Basis   | ✓                   |                        |                     |
|                           | Energy efficient with multi-layer insulation • Energieeffizienz mit Mehrschichtisolierung   | ✓                   |                        |                     |
|                           | Tool-Free Cabinetry • Paneel mit einfacher Öffnung (kein Werkzeug erforderlich)   | ✓                   |                        |                     |
|                           | Interior Dual multicolor LED Lighting • Mehrfarbige, doppelte LED-Innenbeleuchtung  | ✓                   |                        |                     |
|                           | Exterior Corner White LED Lighting • Weiße, äußere LED-Eckleuchten  | ✓                   |                        |                     |
|                           | SmartTub® System  | ✓                   |                        |                     |
|                           | ProTouch™ Touch Screen Controls • Kontrollanzeige ProTouch™   | ✓                   |                        |                     |
|                           | Quick Drain System • Quick drain (Schnelle Entleerung)  | ✓                   |                        |                     |
|                           | ProLast™ Last • Wärmeabdeckung ProLast™   | Black • Schwarz     |                        |                     |
| <b>SKIRTING • PANEELE</b> | ProFinish™  | <b>BRUSHED GRAY</b> | <b>MODERN HARDWOOD</b> | <b>SMOKED EBONY</b> |
|                           | Without Stereo System   | YW12RUOEMT          | YW12RDOEMT             | YW12RYOEMT          |
|                           | Ohne Stereo System  | YW76RUOEMT          | YW76RDOEMT             | YW76RYOEMT          |
| <b>€ 25.700</b>           |   |                     |                        |                     |

**INSULATING COVER to be included in the order • WÄRMEABDECKUNG Muss im Auftrag enthalten sein**

|  |          |                 |                |
|--|----------|-----------------|----------------|
|  | PROLAST™ | Black • Schwarz | 903003950      |
|  |          |                 | <b>€ 1.500</b> |

**ACCESSOIRES • ZUBEHÖRE**

|            |   |                        |
|------------|---|------------------------|
|            | SmartTub® Three-phase Upgrade Kit • Dreiphasen-Adapter-Kit                                  | 919405320              |
|            |   | <b>€ 380</b>           |
| <b>new</b> | SmartTub® Wireless Sensor Kit • Kit Wireless-Sensoren SmartTub®                             | 919405450              |
|            |   | <b>€ 560</b>           |
|            | VersaStep™ • Stufe VersaStep™   | ProFinish®             |
|            |   | <b>BRUSHED GRAY</b>    |
|            |   | <b>MODERN HARDWOOD</b> |
|            |   | <b>SMOKED EBONY</b>    |
|            |   | 890011360              |
|            |   | 890011350              |
|            |   | 890011370              |
|            |   | <b>€ 602</b>           |
| <b>new</b> | Cover lifter manual drop-behind<br>Manueller Lift für Wärmeabdeckung (hinter dem Whirlpool) | 890011440              |
|            |   | <b>€ 1.310</b>         |
|            | Cover lifter manual • Manueller Lift für Wärmeabdeckung                                     | 890011450              |
|            |   | <b>€ 541</b>           |
|            | Cover lifter hydraulic assist • Hydraulischer Heber für Wärmeabdeckung                      | 890011460              |
|            |   | <b>€ 757</b>           |

*Jacuzzi*®





J-300™ COLLECTION



J-335™



# J-385™

Design Jacuzzi®

231 x 231 x 95 H cm

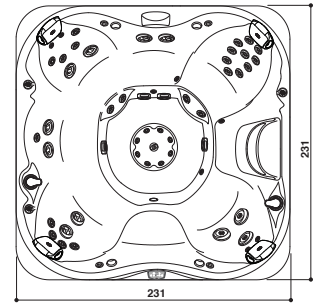

## FEATURES • VERSIONEN

|  |  | FREESTANDING |
|--|--|--------------|
|  | Seats (total)<br>Sitzflächen (insgesamt)   | <b>6-7</b>   |
|  | Lounge   | --           |
|  | Jets<br>Düsen  | <b>51</b>    |
|  | Waterfall with lights<br>Beleuchteter Wasserfall   | ✓            |
|  | HydroSoothe™ hydromassage headrest<br>HydroSoothe™ Hydromassage-Kopfstütze                                 | <b>1</b>     |
|  | Headrest • Kopfstütze  | <b>3</b>     |
|  | Underwater LED multicolor light<br>Mehrfarbige Unterwasser-LED-Leuchte                                     | ✓            |
|  | LED control panel<br>LED - Display   | ✓            |
|  | External corner lighting<br>Außenecken-Beleuchtung   | ✓            |
|  | CLEARRAY Active Oxygen™<br>Low output ozone generator + UV-C<br>Ozongenerator mit geringer Emission + UV-C | ✓            |

|  |   |          |           |  |  |
|--|---|----------|-----------|--|--|
|  | SmartTub®   | Optional | 919405440 |  |  |
|  | SmartTub® Three-phase upgrade kit<br>Dreiphasen-Adapter-Kit |          | € 1.202   |  |  |
|  |   |          | 919405320 |  |  |
|  |   |          | € 380     |  |  |

| SKIRTING • PANEELE |   | ProFinish™   | FINISHING • AUSFÜHRUNGEN | BRUSHED GREY | MODERN HARDWOOD         | SMOKED EBONY |
|--------------------|---|--------------|--------------------------|--------------|-------------------------|--------------|
|                    |   |              |                          |              | Bluewave™ Stereo System | Platinum     |
|                    |   | Silver Pearl | Z333ZU0EW4T              | Z333ZD0EW4T  | Z333ZY0EW4T             |              |
|                    |   | Midnight     | Z362ZU0EW4T              | Z362ZD0EW4T  | Z362ZY0EW4T             |              |
|                    |   | Porcelain    | Z376ZU0EW4T              | Z376ZD0EW4T  | Z376ZY0EW4T             |              |
|                    |   |              |                          | € 26.015     |                         |              |
|                    | Without Stereo System<br>Ohne Stereo System | Platinum     | Z212ZU0EW4T              | Z212ZD0EW4T  | Z212ZY0EW4T             |              |
|                    |   | Silver Pearl | Z233ZU0EW4T              | Z233ZD0EW4T  | Z233ZY0EW4T             |              |
|                    |   | Midnight     | Z262ZU0EW4T              | Z262ZD0EW4T  | Z262ZY0EW4T             |              |
|                    |   | Porcelain    | Z276ZU0EW4T              | Z276ZD0EW4T  | Z276ZY0EW4T             |              |
|                    |   |              |                          | € 23.405     |                         |              |

## INSULATING COVER to be included in the order • WÄRMEABDECKUNG Muss im Auftrag enthalten sein

|  |          |                  |           |
|--|----------|------------------|-----------|
|  | PROLAST™ | Black<br>Schwarz | 903002941 |
|  |          |                  | € 1.491   |

## ACCESSOIRES • ZUBEHÖRE

|  |  |  |           |           |           |
|--|--|--|-----------|-----------|-----------|
|  |  | SmartTub® Wireless Sensor Kit<br>Kit Wireless-Sensoren SmartTub®               | 919405450 |           |           |
|  |  |  | € 560     |           |           |
|  |  | VersaStep™<br>Stufe VersaStep™   | 890011360 | 890011350 | 890011370 |
|  |  |  | € 602     |           |           |
|  |  | J-300™ Covermate manual<br>Abdeckungsheber J-300™ manuell                      | 890011450 |           |           |
|  |  |  | € 541     |           |           |
|  |  | J-300™ Cover lifter hydraulic assist<br>Hydraulischer Heber für Wärmeabdeckung | 890011460 |           |           |
|  |  |  | € 757     |           |           |





**J-375™**  
Design Jacuzzi®



231 x 231 x 95 H cm  
231 x 231 x 93 H cm Made in Italy

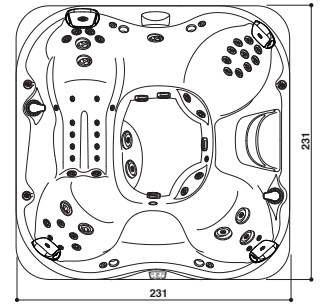

**FEATURES • VERSIONEN**

|  |   |
|--|---|
|  | Seats (total) • Sitzflächen (insgesamt)   |
|  | Lounge  |
|  | Jets • Düsen  |
|  | Waterfall with lights • Beleuchteter Wasserfall   |
|  | HydroSoothe™ hydromassage headrest • Hydromassage-Kopfstütze  |
|  | Headrest • Kopfstütze   |
|  | Underwater LED multicolor light<br>Mehrfarbige Unterwasser-LED-Leuchte                                      |
|  | LED control panel • LED - Display   |
|  | External corner lighting • Außenecken-Beleuchtung   |
|  | CLEARARRAY Active Oxygen™ • Low output ozone generator + UV-C<br>Ozongenerator mit geringer Emission + UV-C |

**FREESTANDING**

|  |            |
|--|------------|
|  | <b>5-6</b> |
|  | <b>1</b>   |
|  | <b>52</b>  |
|  | <b>✓</b>   |
|  | <b>1</b>   |
|  | <b>3</b>   |
|  | <b>✓</b>   |
|  | <b>✓</b>   |
|  | <b>✓</b>   |
|  | <b>✓</b>   |

|  |   |          |           |  |  |
|--|---|----------|-----------|--|--|
|  | SmartTub®   | Optional | 919405440 |  |  |
|  | Three-phase upgrade kit<br>Dreiphasen-Adapter-Kit |          | € 1.202   |  |  |
|  |   |          | 919405320 |  |  |
|  |   |          | € 380     |  |  |

| SKIRTING • PANEEL |  | ProFinish™ | FINISHING • AUSFÜHRUNGEN | BRUSHED GREY | MODERN HARDWOOD | SMOKED EBONY |
|-------------------|--|------------|--------------------------|--------------|-----------------|--------------|
|                   | SmartTub®<br>Bluewave™ Stereo System                     |            | Platinum                 | ZM12ZU0EWM40 | -               | ZM12ZY0EWM40 |
|                   |  |            | Silver Pearl             | ZM33ZU0EWM40 | -               | ZM33ZY0EWM40 |
|                   |  |            | Midnight                 | ZM62ZU0EWM40 | -               | ZM62ZY0EWM40 |
|                   |  |            | Porcelain                | ZM76ZU0EWM40 | -               | ZM76ZY0EWM40 |
|                   |  |            |                          | € 26.597     | -               | € 26.597     |
|                   | SmartTub®<br>Without Stereo System<br>Ohne Stereo System |            | Platinum                 | ZG12ZU0EWM40 | -               | ZG12ZY0EWM40 |
|                   |  |            | Silver Pearl             | ZG33ZU0EWM40 | -               | ZG33ZY0EWM40 |
|                   |  |            | Midnight                 | ZG62ZU0EWM40 | -               | ZG62ZY0EWM40 |
|                   |  |            | Porcelain                | ZG76ZU0EWM40 | -               | ZG76ZY0EWM40 |
|                   |  |            |                          | € 24.037     | -               | € 24.037     |
|                   | Bluewave™ Stereo System                                  |            | Platinum                 | ZM12ZU0EW40  | ZM12ZD0EW4T     | ZM12ZY0EW40  |
|                   |  |            | Silver Pearl             | ZM33ZU0EW40  | ZM33ZD0EW4T     | ZM33ZY0EW40  |
|                   |  |            | Midnight                 | ZM62ZU0EW40  | ZM62ZD0EW4T     | ZM62ZY0EW40  |
|                   |  |            | Porcelain                | ZM76ZU0EW40  | ZM76ZD0EW4T     | ZM76ZY0EW40  |
|                   |  |            |                          | € 25.707     | € 26.442        | € 25.707     |
|                   | Without Stereo System<br>Ohne Stereo System              |            | Platinum                 | ZG12ZU0EW40  | ZG12ZD0EW4T     | ZG12ZY0EW40  |
|                   |  |            | Silver Pearl             | ZG33ZU0EW40  | ZG33ZD0EW4T     | ZG33ZY0EW40  |
|                   |  |            | Midnight                 | ZG62ZU0EW40  | ZG62ZD0EW4T     | ZG62ZY0EW40  |
|                   |  |            | Porcelain                | ZG76ZU0EW40  | ZG76ZD0EW4T     | ZG76ZY0EW40  |
|                   |  |            |                          | € 23.147     | € 23.809        | € 23.147     |

**INSULATING COVER to be included in the order • WÄRMEABDECKUNG Muss im Auftrag enthalten sein**

|  |          |                 |           |
|--|----------|-----------------|-----------|
|  | PROLAST™ | Black • Schwarz | 903002941 |
|  |          |                 | € 1.491   |

**ACCESSOIRES • ZUBEHÖRE**

|  |  |  |                                     |
|--|--|--|-------------------------------------|
|  | SmartTub® Wireless Sensor Kit<br>Kit Wireless-Sensoren SmartTub®               |  | 919405450                           |
|  |  |  | € 560                               |
|  | VersaStep™<br>Stufe VersaStep™   |  | <b>BRUSHED GREY</b><br>890011360    |
|  |  |  | <b>MODERN HARDWOOD</b><br>890011350 |
|  |  |  | 890011370                           |
|  |  |  | € 602                               |
|  | J-300™ Covermate manual<br>Abdeckungsheber J-300™ manuell                      |  | 890011450                           |
|  |  |  | € 541                               |
|  | J-300™ Cover lifter hydraulic assist<br>Hydraulischer Heber für Wärmeabdeckung |  | 890011460                           |
|  |  |  | € 757                               |



# J-365™

Design Jacuzzi®

231 x 214 x 95 H cm

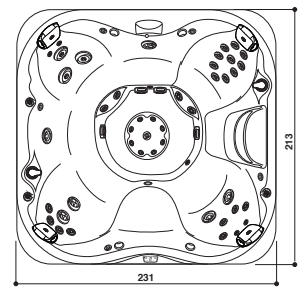

## FEATURES • VERSIONEN

|  |  | FREESTANDING |  |  |
|--|--|--------------|--|--|
|  | Seats (total)<br>Sitzflächen (insgesamt)   | 6-7          |  |  |
|  | Lounge   | --           |  |  |
|  | Jets<br>Düsen  | 46           |  |  |
|  | Waterfall with lights<br>Beleuchteter Wasserfall   | ✓            |  |  |
|  | HydroSoothe™ hydromassage headrest<br>HydroSoothe™ Hydromassage-Kopfstütze                                 | 1            |  |  |
|  | Headrest<br>Kopfstütze   | 3            |  |  |
|  | Underwater LED multicolor light<br>Mehrfarbige Unterwasser-LED-Leuchte                                     | ✓            |  |  |
|  | LED control panel<br>LED - Display   | ✓            |  |  |
|  | External corner lighting<br>Außenecken-Beleuchtung   | ✓            |  |  |
|  | CLEARRAY Active Oxygen™<br>Low output ozone generator + UV-C<br>Ozongenerator mit geringer Emission + UV-C | ✓            |  |  |

|  |   |          |           |  |  |
|--|---|----------|-----------|--|--|
|  | SmartTub®   | Optional | 919405440 |  |  |
|  | SmartTub® Three-phase upgrade kit<br>Dreiphasen-Adapter-Kit |          | € 1.202   |  |  |
|  |   |          | 919405320 |  |  |
|  |   |          | € 380     |  |  |

| SKIRTING • PANEELE |   | ProFinish™ | FINISHING • AUSFÜHRUNGEN | BRUSHED GREY | MODERN HARDWOOD | SMOKED EBONY |
|--------------------|---|------------|--------------------------|--------------|-----------------|--------------|
|                    | Bluewave™ Stereo System                     |            | Platinum                 | ZL12ZU0EW4T  | ZL12ZD0EW4T     | ZL12ZY0EW4T  |
|                    |   |            | Silver Pearl             | ZL33ZU0EW4T  | ZL33ZD0EW4T     | ZL33ZY0EW4T  |
|                    |   |            | Midnight                 | ZL62ZU0EW4T  | ZL62ZD0EW4T     | ZL62ZY0EW4T  |
|                    |   |            | Porcelain                | ZL76ZU0EW4T  | ZL76ZD0EW4T     | ZL76ZY0EW4T  |
|                    |   |            |                          | € 25.439     |                 |              |
|                    | Without Stereo System<br>Ohne Stereo System |            | Platinum                 | ZF12ZU0EW4T  | ZF12ZD0EW4T     | ZF12ZY0EW4T  |
|                    |   |            | Silver Pearl             | ZF33ZU0EW4T  | ZF33ZD0EW4T     | ZF33ZY0EW4T  |
|                    |   |            | Midnight                 | ZF62ZU0EW4T  | ZF62ZD0EW4T     | ZF62ZY0EW4T  |
|                    |   |            | Porcelain                | ZF76ZU0EW4T  | ZF76ZD0EW4T     | ZF76ZY0EW4T  |
|                    |   |            |                          | € 22.859     |                 |              |

## INSULATING COVER to be included in the order • WÄRMEABDECKUNG Muss im Auftrag enthalten sein

|  |          |                  |           |
|--|----------|------------------|-----------|
|  | PROLAST™ | Black<br>Schwarz | 903003221 |
|  |          |                  | € 1.398   |

## ACCESSOIRES • ZUBEHÖRE

|  |  |  |           |           |           |
|--|--|--|-----------|-----------|-----------|
|  |  | SmartTub® Wireless Sensor Kit<br>Kit Wireless-Sensoren SmartTub®               | 919405450 |           |           |
|  |  |  | € 560     |           |           |
|  |  | VersaStep™<br>Stufe VersaStep™   | 890011360 | 890011350 | 890011370 |
|  |  |  | € 602     |           |           |
|  |  | J-300™ Covermate manual<br>Abdeckungsheber J-300™ manuell                      | 890011450 |           |           |
|  |  |  | € 541     |           |           |
|  |  | J-300™ Cover lifter hydraulic assist<br>Hydraulischer Heber für Wärmeabdeckung | 890011460 |           |           |
|  |  |  | € 757     |           |           |



**J-355™** LOUNGE  
Design Jacuzzi®

**SmartTub®**

231 x 214 x 95 H cm  
231 x 214 x 93 H cm Made in Italy

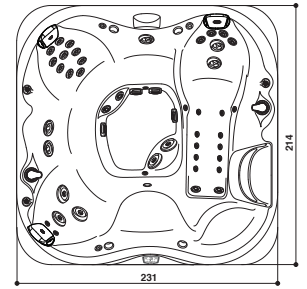

**FEATURES • VERSIONEN**

|  |   |
|--|---|
|  | Seats (total) • Sitzflächen (insgesamt)   |
|  | Lounge  |
|  | Jets • Düsen  |
|  | Waterfall with lights • Beleuchteter Wasserfall   |
|  | HydroSoothe™ hydromassage headrest • Hydromassage-Kopfstütze  |
|  | Headrest • Kopfstütze   |
|  | Underwater LED multicolor light<br>Mehrfarbige Unterwasser-LED-Leuchte                                    |
|  | LED control panel • LED - Display   |
|  | External corner lighting • Außenecken-Beleuchtung   |
|  | CLEARRAY Active Oxygen™ • Low output ozone generator + UV-C<br>Ozongenerator mit geringer Emission + UV-C |

**FREESTANDING**

|     |
|-----|
| 5-6 |
| 1   |
| 44  |
| ✓   |
| 1   |
| 3   |
| ✓   |
| ✓   |
| ✓   |
| ✓   |

|  |   |          |           |
|--|---|----------|-----------|
|  | SmartTub®   | Optional | 919405440 |
|  | Three-phase upgrade kit<br>Dreiphasen-Adapter-Kit |          | € 1.202   |
|  |   |          | 919405320 |
|  |   |          | € 380     |

| SKIRTING • PANEELE |  | ProFinish™ | FINISHING • AUSFÜHRUNGEN | BRUSHED GREY | MODERN HARDWOOD | SMOKED EBONY |
|--------------------|--|------------|--------------------------|--------------|-----------------|--------------|
|                    | SmartTub®<br>Bluewave™ Stereo System                     |            | Platinum                 | ZK12ZU0EWM40 | -               | ZK12ZY0EWM40 |
|                    |  |            | Silver Pearl             | ZK33ZU0EWM40 | -               | ZK33ZY0EWM41 |
|                    |  |            | Midnight                 | ZK62ZU0EWM40 | -               | ZK62ZY0EWM40 |
|                    |  |            | Porcelain                | ZK76ZU0EWM40 | -               | ZK76ZY0EWM40 |
|                    |  |            |                          | € 26.153     | -               | € 26.153     |
|                    | SmartTub®<br>Without Stereo System<br>Ohne Stereo System |            | Platinum                 | ZE12ZU0EWM40 | -               | ZE12ZY0EWM40 |
|                    |  |            | Silver Pearl             | ZE33ZU0EWM40 | -               | ZE33ZY0EWM40 |
|                    |  |            | Midnight                 | ZE62ZU0EWM40 | -               | ZE62ZY0EWM40 |
|                    |  |            | Porcelain                | ZE76ZU0EWM40 | -               | ZE76ZY0EWM40 |
|                    |  |            |                          | € 23.597     | -               | € 23.597     |
|                    | Bluewave™ Stereo System                                  |            | Platinum                 | ZK12ZU0EW40  | ZK12ZD0EW4T     | ZK12ZY0EW40  |
|                    |  |            | Silver Pearl             | ZK33ZU0EW40  | ZK33ZD0EW4T     | ZK33ZY0EW40  |
|                    |  |            | Midnight                 | ZK62ZU0EW40  | ZK62ZD0EW4T     | ZK62ZY0EW40  |
|                    |  |            | Porcelain                | ZK76ZU0EW40  | ZK76ZD0EW4T     | ZK76ZY0EW40  |
|                    |  |            |                          | € 25.263     | € 25.985        | € 25.263     |
|                    | Without Stereo System<br>Ohne Stereo System              |            | Platinum                 | ZE12ZU0EW40  | ZE12ZD0EW4T     | ZE12ZY0EW40  |
|                    |  |            | Silver Pearl             | ZE33ZU0EW40  | ZE33ZD0EW4T     | ZE33ZY0EW40  |
|                    |  |            | Midnight                 | ZE62ZU0EW40  | ZE62ZD0EW4T     | ZE62ZY0EW40  |
|                    |  |            | Porcelain                | ZE76ZU0EW40  | ZE76ZD0EW4T     | ZE76ZY0EW40  |
|                    |  |            |                          | € 22.707     | € 23.356        | € 22.707     |

**INSULATING COVER to be included in the order • WÄRMEABDECKUNG Muss im Auftrag enthalten sein**

|  |          |                 |           |
|--|----------|-----------------|-----------|
|  | PROLAST™ | Black • Schwarz | 903003221 |
|  |          |                 | € 1.398   |

**ACCESSOIRES • ZUBEHÖRE**

|  |  |  |           |
|--|--|--|-----------|
|  |  | SmartTub® Wireless Sensor Kit<br>Kit Wireless-Sensoren SmartTub®               | 919405450 |
|  |  |  | € 560     |
|  |  | VersaStep™<br>Stufe VersaStep™   | 890011360 |
|  |  | J-300™ Covermate manual<br>Abdeckungsheber J-300™ manuell                      | 890011450 |
|  |  |  | € 602     |
|  |  | J-300™ Cover lifter hydraulic assist<br>Hydraulischer Heber für Wärmeabdeckung | 890011460 |
|  |  |  | € 757     |





# J-345™

Design Jacuzzi®

214 x 214 x 91 H cm

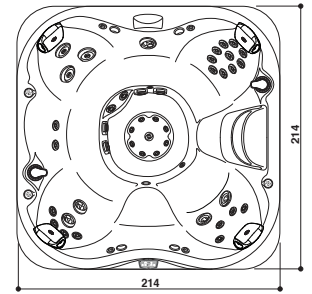

## FEATURES • VERSIONEN

|  |  | FREESTANDING |  |  |
|--|--|--------------|--|--|
|  | Seats (total)<br>Sitzflächen (insgesamt)   | 6-7          |  |  |
|  | Lounge   | --           |  |  |
|  | Jets<br>Düsen  | 41           |  |  |
|  | Waterfall with lights<br>Beleuchteter Wasserfall   | ✓            |  |  |
|  | HydroSoothe™ hydromassage headrest<br>HydroSoothe™ Hydromassage-Kopfstütze                                 | 1            |  |  |
|  | Headrest<br>Kopfstütze   | 3            |  |  |
|  | Underwater LED multicolor light<br>Mehrfarbige Unterwasser-LED-Leuchte                                     | ✓            |  |  |
|  | LED control panel<br>LED - Display   | ✓            |  |  |
|  | External corner lighting<br>Außenecken-Beleuchtung   | ✓            |  |  |
|  | CLEARRAY Active Oxygen™<br>Low output ozone generator + UV-C<br>Ozongenerator mit geringer Emission + UV-C | ✓            |  |  |

|  |   |          |           |  |  |
|--|---|----------|-----------|--|--|
|  | SmartTub®   | Optional | 919405440 |  |  |
|  |   |          | € 1.202   |  |  |
|  | SmartTub® Three-phase upgrade kit<br>Dreiphasen-Adapter-Kit |          | 919405320 |  |  |
|  |   |          | € 380     |  |  |

| SKIRTING • PANEELE |   | ProFinish™ | FINISHING • AUSFÜHRUNGEN | BRUSHED GREY | MODERN HARDWOOD | SMOKED EBONY |
|--------------------|---|------------|--------------------------|--------------|-----------------|--------------|
|                    | Bluewave™ Stereo System                     |            | Platinum                 | ZJ12ZU0EW4T  | ZJ12ZD0EW4T     | ZJ12ZY0EW4T  |
|                    |   |            | Silver Pearl             | ZJ33ZU0EW4T  | ZJ33ZD0EW4T     | ZJ33ZY0EW4T  |
|                    |   |            | Midnight                 | ZJ62ZU0EW4T  | ZJ62ZD0EW4T     | ZJ62ZY0EW4T  |
|                    |   |            | Porcelain                | ZJ76ZU0EW4T  | ZJ76ZD0EW4T     | ZJ76ZY0EW4T  |
|                    |   |            |                          | € 23.896     |                 |              |
|                    | Without Stereo System<br>Ohne Stereo System |            | Platinum                 | ZD12ZU0EW4T  | ZD12ZD0EW4T     | ZD12ZY0EW4T  |
|                    |   |            | Silver Pearl             | ZD33ZU0EW4T  | ZD33ZD0EW4T     | ZD33ZY0EW4T  |
|                    |   |            | Midnight                 | ZD62ZU0EW4T  | ZD62ZD0EW4T     | ZD62ZY0EW4T  |
|                    |   |            | Porcelain                | ZD76ZU0EW4T  | ZD76ZD0EW4T     | ZD76ZY0EW4T  |
|                    |   |            |                          | € 21.402     |                 |              |

## INSULATING COVER to be included in the order • WÄRMEABDECKUNG Muss im Auftrag enthalten sein

|  |          |                  |           |
|--|----------|------------------|-----------|
|  | PROLAST™ | Black<br>Schwarz | 903002411 |
|  |          |                  | € 1.395   |

## ACCESSOIRES • ZUBEHÖRE

|  |  |  |                           |                              |                           |
|--|--|--|---------------------------|------------------------------|---------------------------|
|  |  | SmartTub® Wireless Sensor Kit<br>Kit Wireless-Sensoren SmartTub®               | 919405450                 |                              |                           |
|  |  |  | € 560                     |                              |                           |
|  |  | VersaStep™<br>Stufe VersaStep™   | BRUSHED GREY<br>890011360 | MODERN HARDWOOD<br>890011350 | SMOKED EBONY<br>890011370 |
|  |  |  | € 602                     |                              |                           |
|  |  | J-300™ Covermate manual<br>Abdeckungsheber J-300™ manuell                      | 890011450                 |                              |                           |
|  |  |  | € 541                     |                              |                           |
|  |  | J-300™ Cover lifter hydraulic assist<br>Hydraulischer Heber für Wärmeabdeckung | 890011460                 |                              |                           |
|  |  |  | € 757                     |                              |                           |



 **MADE IN ITALY**

**J-335™**  
Design Jacuzzi®







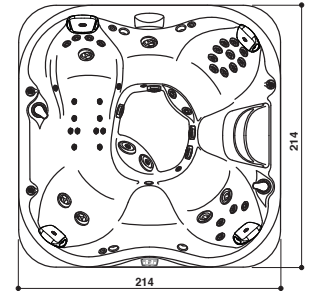





 SmartTub®

214 x 214 x 92 H cm  
214 x 214 x 93 H cm Made in Italy



**FEATURES • VERSIONEN**

|   |   |
|---|---|
|    | Seats (total) • Sitzflächen (insgesamt)   |
|    | Lounge  |
|    | Jets • Düsen  |
|    | Waterfall with lights • Beleuchteter Wasserfall   |
|    | HydroSoothe™ hydromassage headrest • Hydromassage-Kopfstütze  |
|    | Headrest • Kopfstütze   |
|    | Underwater LED multicolor light<br>Mehrfarbige Unterwasser-LED-Leuchte                                      |
|    | LED control panel • LED - Display   |
|   | External corner lighting • Außenecken-Beleuchtung   |
|  | CLEARARRAY Active Oxygen™ • Low output ozone generator + UV-C<br>Ozongenerator mit geringer Emission + UV-C |





**FREESTANDING**

|            |
|------------|
| <b>5-6</b> |
| <b>1</b>   |
| <b>42</b>  |
| <b>1</b>   |
| <b>1</b>   |
| <b>3</b>   |
| ✓          |
| ✓          |
| ✓          |
| ✓          |

|   |   |          |
|---|---|----------|
|  | SmartTub®   | Optional |
|  | Three-phase upgrade kit<br>Dreiphasen-Adapter-Kit |          |

|           |
|-----------|
| 919405440 |
| € 1.202   |
| 919405320 |
| € 380     |

**SKIRTING • PANEELI** ProFinish™ **FINISHING • AUSFÜHRUNGEN**

|  |              | BRUSHED GREY | MODERN HARDWOOD | SMOKED EBONY |
|--|--------------|--------------|-----------------|--------------|
|  SmartTub®<br>Bluewave™ Stereo System                     | Platinum     | ZP12ZU0EWM40 | -               | ZP12ZY0EWM40 |
|  | Silver Pearl | ZP33ZU0EWM40 | -               | ZP33ZY0EWM40 |
|  | Midnight     | ZP62ZU0EWM40 | -               | ZP62ZY0EWM40 |
|  | Porcelain    | ZP76ZU0EWM40 | -               | ZP76ZY0EWM40 |
|  |              | € 24.625     | -               | € 24.625     |
|  SmartTub®<br>Without Stereo System<br>Ohne Stereo System | Platinum     | ZC12ZU0EWM40 | -               | ZC12ZY0EWM40 |
|  | Silver Pearl | ZC33ZU0EWM40 | -               | ZC33ZY0EWM40 |
|  | Midnight     | ZC62ZU0EWM40 | -               | ZC62ZY0EWM40 |
|  | Porcelain    | ZC76ZU0EWM40 | -               | ZC76ZY0EWM40 |
|  |              | € 22.150     | -               | € 22.150     |
|  Bluewave™ Stereo System                                  | Platinum     | ZP12ZU0EW40  | ZP12ZD0EW4T     | ZP12ZY0EW40  |
|  | Silver Pearl | ZP33ZU0EW40  | ZP33ZD0EW4T     | ZP33ZY0EW40  |
|  | Midnight     | ZP62ZU0EW40  | ZP62ZD0EW4T     | ZP62ZY0EW40  |
|  | Porcelain    | ZP76ZU0EW40  | ZP76ZD0EW4T     | ZP76ZY0EW40  |
|  |              | € 23.735     | € 24.413        | € 23.735     |
|  Without Stereo System<br>Ohne Stereo System              | Platinum     | ZC12ZU0EW40  | ZC12ZD0EW4T     | ZC12ZY0EW40  |
|  | Silver Pearl | ZC33ZU0EW40  | ZC33ZD0EW4T     | ZC33ZY0EW40  |
|  | Midnight     | ZC62ZU0EW40  | ZC62ZD0EW4T     | ZC62ZY0EW40  |
|  | Porcelain    | ZC76ZU0EW40  | ZC76ZD0EW4T     | ZC76ZY0EW40  |
|  |              | € 21.260     | € 21.868        | € 21.260     |

**INSULATING COVER to be included in the order • WÄRMEABDECKUNG Muss im Auftrag enthalten sein**

|   |          |                  |           |
|---|----------|------------------|-----------|
|  | PROLAST™ | Black<br>Schwarz | 903002411 |
|   |          |                  | € 1.395   |

**ACCESSOIRES • ZUBEHÖRE**

|   |   |  |           |
|---|---|--|-----------|
|   |  | SmartTub® Wireless Sensor Kit<br>Kit Wireless-Sensoren SmartTub®               | 919405450 |
|   |   |  | € 560     |
|  |   | VersaStep™<br>Stufe VersaStep™   | 890011360 |
|  |   | J-300™ Covermate manual<br>Abdeckungsheber J-300™ manuell                      | 890011450 |
|  |   | J-300™ Cover lifter hydraulic assist<br>Hydraulischer Heber für Wärmeabdeckung | 890011460 |
|   |   |  | € 602     |
|   |   |  | € 541     |
|   |   |  | € 757     |

| BRUSHED GREY | MODERN HARDWOOD | SMOKED EBONY |
|--------------|-----------------|--------------|
| 890011360    | 890011350       | 890011370    |
|              |                 |              |
|              |                 |              |
|              |                 |              |
|              |                 |              |



# J-325™

Design Jacuzzi®

193 x 214 x 85 H cm

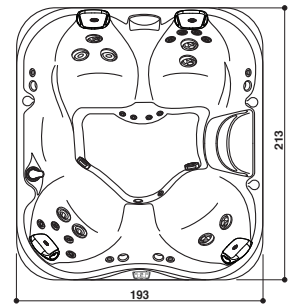

## FEATURES • VERSIONEN

|  |  |  |                     |  |  |
|--|--|--|---------------------|--|--|
|  | Seats (total)<br>Sitzflächen (insgesamt)   |  | <b>FREESTANDING</b> |  |  |
|  | Lounge   |  | 4-5                 |  |  |
|  | Jets<br>Düsen  |  | --                  |  |  |
|  | Waterfall with lights<br>Beleuchteter Wasserfall   |  | 23                  |  |  |
|  | HydroSoothe™ hydromassage headrest<br>HydroSoothe™ Hydromassage-Kopfstütze                                 |  | ✓                   |  |  |
|  | Headrest<br>Kopfstütze   |  | 1                   |  |  |
|  | Underwater LED multicolor light<br>Mehrfarbige Unterwasser-LED-Leuchte                                     |  | 3                   |  |  |
|  | LED control panel<br>LED - Display   |  | ✓                   |  |  |
|  | External corner lighting<br>Außenecken-Beleuchtung   |  | ✓                   |  |  |
|  | CLEARRAY Active Oxygen™<br>Low output ozone generator + UV-C<br>Ozongenerator mit geringer Emission + UV-C |  | ✓                   |  |  |

|  |   |          |           |  |  |
|--|---|----------|-----------|--|--|
|  | SmartTub®   | Optional | 919405440 |  |  |
|  | SmartTub® Three-phase upgrade kit<br>Dreiphasen-Adapter-Kit |          | € 1.202   |  |  |
|  |   |          | 919405320 |  |  |
|  |   |          | € 380     |  |  |

| SKIRTING • PANEELE |   | ProFinish™ | FINISHING • AUSFÜHRUNGEN | BRUSHED GREY | MODERN HARDWOOD | SMOKED EBONY |
|--------------------|---|------------|--------------------------|--------------|-----------------|--------------|
|                    | Bluewave™ Stereo System                     |            | Platinum                 | Z512ZU0EW4T  | Z512ZD0EW4T     | Z512ZY0EW4T  |
|                    |   |            | Silver Pearl             | Z533ZU0EW4T  | Z533ZD0EW4T     | Z533ZY0EW4T  |
|                    |   |            | Midnight                 | Z562ZU0EW4T  | Z562ZD0EW4T     | Z562ZY0EW4T  |
|                    |   |            | Porcelain                | Z576ZU0EW4T  | Z576ZD0EW4T     | Z576ZY0EW4T  |
|                    |   |            |                          | € 22.445     |                 |              |
|                    | Without Stereo System<br>Ohne Stereo System |            | Platinum                 | ZB12ZU0EW4T  | ZB12ZD0EW4T     | ZB12ZY0EW4T  |
|                    |   |            | Silver Pearl             | ZB33ZU0EW4T  | ZB33ZD0EW4T     | ZB33ZY0EW4T  |
|                    |   |            | Midnight                 | ZB62ZU0EW4T  | ZB62ZD0EW4T     | ZB62ZY0EW4T  |
|                    |   |            | Porcelain                | ZB76ZU0EW4T  | ZB76ZD0EW4T     | ZB76ZY0EW4T  |
|                    |   |            |                          | € 20.098     |                 |              |

|   |          |                  |           |
|---|----------|------------------|-----------|
| <b>INSULATING COVER to be included in the order • WÄRMEABDECKUNG Muss im Auftrag enthalten sein</b> |          |                  |           |
|   | PROLAST™ | Black<br>Schwarz | 903003590 |
|   |          |                  | € 1.328   |

|                               |  |  |           |           |           |
|-------------------------------|--|--|-----------|-----------|-----------|
| <b>ACCESSOIRES • ZUBEHÖRE</b> |  |  |           |           |           |
|                               |  | SmartTub® Wireless Sensor Kit<br>Kit Wireless-Sensoren SmartTub®               | 919405450 |           |           |
|                               |  |  | € 560     |           |           |
|                               |  | VersaStep™<br>Stufe VersaStep™   | 890011360 | 890011350 | 890011370 |
|                               |  |  | € 602     |           |           |
|                               |  | J-300™ Covermate manual<br>Abdeckungsheber J-300™ manuell                      | 890011450 |           |           |
|                               |  |  | € 541     |           |           |
|                               |  | J-300™ Cover lifter hydraulic assist<br>Hydraulischer Heber für Wärmeabdeckung | 890011460 |           |           |
|                               |  |  | € 757     |           |           |





**J-315™**  
Design Jacuzzi®



193 x 168 x 81 H cm

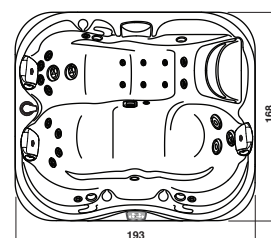

**FEATURES • VERSIONEN**

|  |  |
|--|--|
|  | Seats (total)<br>Sitzflächen (insgesamt)   |
|  | Lounge   |
|  | Jets<br>Düsen  |
|  | Waterfall with lights<br>Beleuchteter Wasserfall   |
|  | HydroSoothe™ hydromassage headrest<br>HydroSoothe™ Hydromassage-Kopfstütze                                 |
|  | Headrest<br>Kopfstütze   |
|  | Underwater LED multicolor light<br>Mehrfarbige Unterwasser-LED-Leuchte                                     |
|  | LED control panel<br>LED - Display   |
|  | External corner lighting<br>Außenecken-Beleuchtung   |
|  | CLEARRAY Active Oxygen™<br>Low output ozone generator + UV-C<br>Ozongenerator mit geringer Emission + UV-C |

| FREESTANDING |  |  |
|--------------|--|--|
| <b>2-3</b>   |  |  |
| <b>1</b>     |  |  |
| <b>23</b>    |  |  |
| ✓            |  |  |
| <b>1</b>     |  |  |
| <b>2</b>     |  |  |
| ✓            |  |  |
| ✓            |  |  |
| ✓            |  |  |
| ✓            |  |  |

|  |   |          |           |  |  |
|--|---|----------|-----------|--|--|
|  | SmartTub®   | Optional | 919405440 |  |  |
|  | SmartTub® Three-phase upgrade kit<br>Dreiphasen-Adapter-Kit |          | € 1.202   |  |  |
|  |   |          | 919405320 |  |  |
|  |   |          | € 380     |  |  |

| SKIRTING • PANEELLE |   | ProFinish™ | FINISHING • AUSFÜHRUNGEN | BRUSHED GREY | MODERN HARDWOOD | SMOKED EBONY |
|---------------------|---|------------|--------------------------|--------------|-----------------|--------------|
|                     | Bluewave™ Stereo System                     |            | Platinum                 | Z412ZU0EW4T  | Z412ZD0EW4T     | Z412ZY0EW4T  |
|                     |   |            | Silver Pearl             | Z433ZU0EW4T  | Z433ZD0EW4T     | Z433ZY0EW4T  |
|                     |   |            | Midnight                 | Z462ZU0EW4T  | Z462ZD0EW4T     | Z462ZY0EW4T  |
|                     |   |            | Porcelain                | Z476ZU0EW4T  | Z476ZD0EW4T     | Z476ZY0EW4T  |
|                     |   |            | € 19.648                 |              |                 |              |
|                     | Without Stereo System<br>Ohne Stereo System |            | Platinum                 | ZA12ZU0EW4T  | ZA12ZD0EW4T     | ZA12ZY0EW4T  |
|                     |   |            | Silver Pearl             | ZA33ZU0EW4T  | ZA33ZD0EW4T     | ZA33ZY0EW4T  |
|                     |   |            | Midnight                 | ZA62ZU0EW4T  | ZA62ZD0EW4T     | ZA62ZY0EW4T  |
|                     |   |            | Porcelain                | ZA76ZU0EW4T  | ZA76ZD0EW4T     | ZA76ZY0EW4T  |
|                     |   |            | € 17.127                 |              |                 |              |

**INSULATING COVER to be included in the order • WÄRMEABDECKUNG Muss im Auftrag enthalten sein**

|  |          |                  |           |
|--|----------|------------------|-----------|
|  | PROLAST™ | Black<br>Schwarz | 903003610 |
|  |          |                  | € 1.203   |

**ACCESSOIRES • ZUBEHÖRE**

|  |  |  |           |           |           |
|--|--|--|-----------|-----------|-----------|
|  |  | SmartTub® Wireless Sensor Kit<br>Kit Wireless-Sensoren SmartTub®               | 919405450 |           |           |
|  |  |  | € 560     |           |           |
|  |  | VersaStep™<br>Stufe VersaStep™   | 890011360 | 890011350 | 890011370 |
|  |  | € 602  |           |           |           |
|  |  | J-300™ Covermate manual<br>Abdeckungsheber J-300™ manuell                      | 890011450 |           |           |
|  |  | € 541  |           |           |           |
|  |  | J-300™ Cover lifter hydraulic assist<br>Hydraulischer Heber für Wärmeabdeckung | 890011460 |           |           |
|  |  | € 757  |           |           |           |



# Jacuzzi®





J-200™ CLASSIC



J-235™



# J-245™

Design Jacuzzi®

213 x 213 x 91 H cm

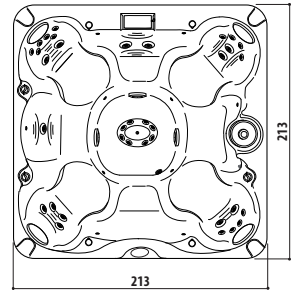

## FEATURES • VERSIONEN

|                   |   | FREESTANDING    |                           |            |
|-------------------|---|-----------------|---------------------------|------------|
|                   | Seats (total)<br>Sitzflächen (insgesamt)  | 6-7             |                           |            |
|                   | Lounge seat<br>Lounge Sitzfläche  | --              |                           |            |
|                   | Jets<br>Düsen   | 35              |                           |            |
|                   | Multicolor LED lighting   | 10              |                           |            |
|                   | Waterfall<br>Wasserfall   | ✓               |                           |            |
|                   | CLEARRAY® Active Oxygen® System Low output ozone generator + UV-C<br>CLEARRAY® Active Oxygen® System Ozongenerator mit geringer Emission + UV-C | ✓               |                           |            |
|                   | Headrest<br>Kopfstütze  | 4               |                           |            |
|                   | LED control panel<br>LED - Display  | ✓               |                           |            |
|                   | EcoShield insulation<br>Eco Shield-Isolierung   | ✓               | --                        |            |
|                   | Nordic insulation (Modular Sealed Foam + Smart Seal)<br>Nordische Isolierung (Modular Sealed Foam + Smart Seal)                                 | --              | ✓                         |            |
|                   | ProLast™ Cover<br>Wärmeabdeckung ProLast™   | Black • Schwarz |                           |            |
| SKIRTING • PANEEL |   | ProFinish™      | FINISHING<br>AUSFÜHRUNGEN |            |
|                   | Without Stereo System<br>Ohne Stereo System   | Platinum        | ZV12ZG0E80                | ZV12ZG0EW0 |

**NOTE:** Porcelain, Silver Pearl, Midnight finishes on request. • **HINWEIS:** Auf Wunsch mit Oberflächenausführung Porcelain, Silver Pearl, Midnight

€ 12.306

€ 12.843

## INSULATING COVER to be included in the order • WÄRMEABDECKUNG Muss im Auftrag enthalten sein

|  |          |                 |           |
|--|----------|-----------------|-----------|
|  | PROLAST™ | Black • Schwarz | 903003211 |
|  |          |                 | € 1.110   |

## ACCESSOIRES • ZUBEHÖRE

|  |   |                 |           |
|--|---|-----------------|-----------|
|  | Smart step<br>Stufe Smart step  | Black • Schwarz | 890011600 |
|  |   |                 | € 526     |
|  | Cover lifter manual<br>Manueller Lift für Wärmeabdeckung                |                 | 890011450 |
|  |   |                 | € 541     |
|  | Cover lifter hydraulic assist<br>Hydraulischer Heber für Wärmeabdeckung |                 | 890011460 |
|  |   |                 | € 757     |
|  | Cover lifter undermount manual<br>Manueller Lift für Wärmeabdeckung     |                 | 890011500 |
|  |   |                 | € 865     |





 **MADE IN ITALY**







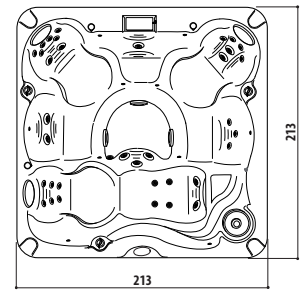



**J-235™**  
Design Jacuzzi®



213 x 213 x 91 H cm



**FEATURES • VERSIONEN**

|   |   | FREESTANDING    |    |
|---|---|-----------------|----|
|    | Seats (total)<br>Sitzflächen (insgesamt)  | <b>6</b>        |    |
|    | Lounge seat<br>Lounge Sitzfläche  | <b>1</b>        |    |
|    | Jets<br>Düsen   | <b>35</b>       |    |
|    | Multicolor LED lighting   | <b>6</b>        |    |
|    | Waterfall<br>Wasserfall   | ✓               |    |
|   | CLEARRAY® Active Oxygen® System Low output ozone generator + UV-C<br>CLEARRAY® Active Oxygen® System Ozongenerator mit geringer Emission + UV-C | ✓               |    |
|  | Headrest<br>Kopfstütze  | <b>3</b>        |    |
|  | LED control panel<br>LED - Display  | ✓               |    |
|  | EcoShield insulation<br>Eco Shield-Isolierung   | ✓               | -- |
|  | Nordic insulation (Modular Sealed Foam + Smart Seal)<br>Nordische Isolierung (Modular Sealed Foam + Smart Seal)                                 | --              | ✓  |
|  | ProLast™ Cover<br>Wärmeabdeckung ProLast™   | Black • Schwarz |    |

**SKIRTING • PANEEL**

ProFinish™

**FINISHING  
AUSFÜHRUNGEN**

SILVERWOOD

|   |   |          |            |            |
|---|---|----------|------------|------------|
|  | Without Stereo System<br>Ohne Stereo System | Platinum | Z112ZG0E80 | Z112ZG0EW0 |
|---|---|----------|------------|------------|

**NOTE:** Porcelain, Silver Pearl, Midnight finishes on request. • **HINWEIS:** Auf Wunsch mit Oberflächenausführung Porcelain, Silver Pearl, Midnight





€ 12.306

€ 12.843

**INSULATING COVER to be included in the order • WÄRMEABDECKUNG Muss im Auftrag enthalten sein**

|   |          |                 |           |
|---|----------|-----------------|-----------|
|  | PROLAST™ | Black • Schwarz | 903003211 |
|   |          |                 | € 1.110   |

**ACCESSOIRES • ZUBEHÖRE**

|   |   |                 |           |
|---|---|-----------------|-----------|
|  | Smart step<br>Stufe Smart step  | Black • Schwarz | 890011600 |
|   |   |                 | € 526     |
|  | Cover lifter manual<br>Manueller Lift für Wärmeabdeckung                |                 | 890011450 |
|   |   |                 | € 541     |
|  | Cover lifter hydraulic assist<br>Hydraulischer Heber für Wärmeabdeckung |                 | 890011460 |
|   |   |                 | € 757     |
|  | Cover lifter undermount manual<br>Manueller Lift für Wärmeabdeckung     |                 | 890011500 |
|   |   |                 | € 865     |

*Jacuzzi*<sup>®</sup>





DESIGN COLLECTION



VIRTUS



## INSTRUCTIONS FOR ORDERING

Dimensions and descriptions are indicated in the master brochure and in this price list.

Orders must include:

- a) name **VIRTUS**
- b) spa code **VIRQ1023354**
- c) cover code **903002472**

NOTE: Optional and accessories marked with dedicated codes to be ordered separately are not included or installed on the product.

---

## HINWEISE ZUR BESTELLUNG

Zur Beschreibung und für die Abmessungen, sollte man sich auf den Katalog und die Preisliste beziehen.

Die Bestellungen sollten folgendes beinhalten:

- a) Name **VIRTUS**
- b) Artikel-Nr. **VIRQ1023354**
- c) Wärmeabdeckung-Nr. **903002472**

NOTE: Optional und accessoires, die mit entsprechenden Codes gekennzeichnet sind, die separat bestellt werden müssen, sind nicht im Produkt inbegriffen oder installiert.

---



**DO NOT USE SEA WATER OR WATER WITH ADDED SALT ON ALL HOT TUB AND SWIM SPA MODELS.**

**ALLE HOT TUB- UND SWIM SPA-MODELLE NICHT MIT MEERWASSER ODER MIT ZUGESETZTEM SALZ VERWENDEN.**





**VIRTUS**

Design Dodo Arslan & Jacuzzi® Design



250 x 215 x 93 H cm

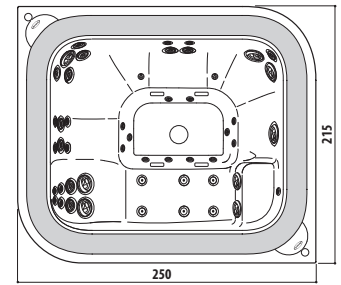

**FEATURES • VERSIONEN**

|  |  |            |
|--|--|------------|
|  | Sièges (total)<br>Sitzflächen (insgesamt)  | <b>6-7</b> |
|  | Lounge   | <b>1</b>   |
|  | Jets<br>Düsen  | <b>50</b>  |
|  | Underwater LED multicolor light<br>Mehrfarbige Unterwasser-LED-Leuchte   | <b>2</b>   |
|  | LED control panel<br>LED - Display   | ✓          |
|  | Back-lit touch controls<br>Rückseitig beleuchtetes Touch-Bedienelement   | <b>2</b>   |
|  | Smart Access Door<br>"Smart Access" Panel  | ✓          |
|  | Automatic water fill-up<br>Automatische Wasserfüllung  | ✓          |
|  | Quick drain<br>Quick drain (Schnelle Entleerung)   | ✓          |
|  | Snap-on cartridge filter with filter surface area of 9,29 m <sup>2</sup> .<br>Kartuschen-Druckfilter mit einer Filterfläche von 9 m <sup>2</sup> . | ✓          |
|  | CLEARRAY Active Oxygen™ Low output ozone generator + UV-C<br>Ozongenerator mit geringer Emission + UV-C  | ✓          |
|  | Eco shield insulation<br>Eco Shield-Isolierung   | ○          |

**NOTE: WATER CONNECTION AND DRAIN REQUIRED  
HINWEIS: WASSER- UND ABWASSERANSCHLUSS ERFORDERLICH**

|  |                          | BUILT-IN        | FREESTANDING    |             |
|--|--------------------------|-----------------|-----------------|-------------|
| SKIRTING • PANEEL                                | FINISHING • AUSFÜHRUNGEN | --              | TEAK            | GRAPHITE    |
| 3 kW electric heater<br>3 kW elektrische Heizung | Platinum                 | VIRR1023050     | VIRR1023353     | VIRR1023354 |
|  | Porcelain                | VIRR0023050     | VIRR0023353     | VIRR0023354 |
|  |                          | <b>€ 23.184</b> | <b>€ 28.286</b> |             |
| Heat exchanger<br>Wärmetauscher                  | Platinum                 | VIRR1021050     | VIRR1021353     | VIRR1021354 |
|  | Porcelain                | VIRR0021050     | VIRR0021353     | VIRR0021354 |
|  |                          | <b>€ 23.830</b> | <b>€ 28.931</b> |             |

**INSULATING COVER to be included in the order • WÄRMEABDECKUNG Muss im Auftrag enthalten sein**

|  |                |                |
|--|----------------|----------------|
| Insulating cover in two folding parts<br>Zweiteilige klappbare Thermoabdeckung | ProVinyl - Ice | 903002472      |
|  |                | <b>€ 2.090</b> |

**NOTE:** Cover lifter not available • **HINWEIS:** Heber für Thermoabdeckung nicht verfügbar

**ACCESSOIRES • ZUBEHÖRE**

|  |                          |
|--|--------------------------|
| AISI 316 L frame • Rahmen aus AISI 316 L | on request • auf Anfrage |
|  | <b>+ € 1.000</b>         |

✓ Standard • Serienmässig

○ Only Freestanding version • Nur bei Freestanding Version



# PROFILE

Design Jacuzzi®



235 x 211 x 93 H cm Built-in / Freestanding Graphite  
239 x 215 x 93 H cm Freestanding Teak

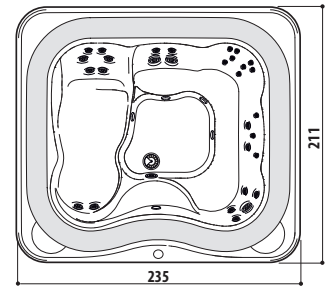

## FEATURES • VERSIONEN

|  |  |            |
|--|--|------------|
|  | Seats (total)<br>Sitzflächen (insgesamt)                               | <b>5-6</b> |
|  | Lounge   | <b>1</b>   |
|  | Jets<br>Düsen  | <b>31</b>  |
|  | Underwater LED multicolor light<br>Mehrfarbige Unterwasser-LED-Leuchte | ✓          |
|  | Automatic water fill-up<br>Automatische Wasserfüllung                  | ✓          |
|  | LCD control panel<br>LCD - Display                                     | <b>1</b>   |
|  | Back-lit touch control<br>Rückseitig beleuchtetes Touch-Bedienelement  | <b>2</b>   |
|  | Quick drain<br>Quick drain (Schnelle Entleerung)                       | ✓          |
|  | CLEARRAY® UV-C system  | ✓          |

**NOTE: WATER CONNECTION AND DRAIN REQUIRED**  
**HINWEIS: WASSER- UND ABWASSERANSCHLUSS ERFORDERLICH**

|                   |  | BUILT-IN        | FREESTANDING    |
|-------------------|--|-----------------|-----------------|
| SKIRTING • PANEEL | FINISHING<br>AUSFÜHRUNGEN                        | --              | GRAPHITE        |
|                   | 3 kW electric heater<br>3 kW elektrische Heizung | PFLP1023050     | PFLP1023054     |
|                   |  | PFLP0023050     | PFLP0023054     |
|                   |  | <b>€ 19.825</b> | <b>€ 23.277</b> |

**INSULATING COVER to be included in the order • WÄRMEABDECKUNG Muss im Auftrag enthalten sein**

|  |          |     |                |
|--|----------|-----|----------------|
|  | PROVINYL | Ice | 903002202      |
|  |          |     | <b>€ 1.257</b> |

**NOTE:** Cover lifter not available • **HINWEIS:** Heber für Thermoabdeckung nicht verfügbar

## ACCESSOIRES • ZUBEHÖRE

|  |   |                          |
|--|---|--------------------------|
|  | Winter Pro Kit  | 943613030                |
|  |   | <b>€ 1.099</b>           |
|  | Performance Kit · Sand not included<br>Sand ist nicht inklusive | 94428200                 |
|  |   | <b>€ 1.808</b>           |
|  | 1 x 25 kg bag of sand<br>1 Sack Sand 25 kg                      | 23320507                 |
|  |   | <b>€ 49</b>              |
| AISI 316 L frame • Rahmen aus AISI 316 L |   | on request • auf Anfrage |
|  |   | <b>+ € 1.000</b>         |



**SANTORINI**

Design Kaluderovic & Condini



230 x 215 x 90 H cm

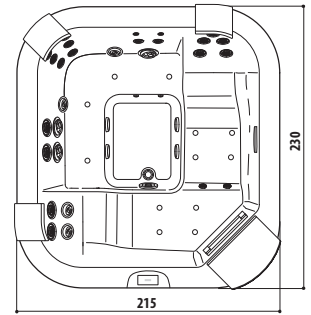

FEATURES • VERSIONEN

|  |  |    |
|--|--|----|
|  | Seats (total)<br>Sitzflächen (insgesamt)                               | 5  |
|  | Lounge   | 2  |
|  | Jets<br>Düsen  | 29 |
|  | Blowers  | 14 |
|  | Underwater LED multicolor light<br>Mehrfarbige Unterwasser-LED-Leuchte | ✓  |
|  | Cascade<br>Wasserfall  | ✓  |
|  | Removable headrests and cushion<br>Abnehmbare Kopfstütze und Kissen    | 4  |
|  | LCD control panel<br>LCD - Display                                     | ✓  |
|  | CLEARRAY® UV-C system  | ✓  |

|                    |  | BUILT-IN  | FREESTANDING |             |
|--------------------|--|-----------|--------------|-------------|
| SKIRTING • PANEELE |  | - -       | TEAK         | GRAPHITE    |
|                    | 3 kW electric heater<br>3 kW elektrische Heizung | Platinum  | SNTP1033010  | SNTP1033013 |
|                    |  | Porcelain | SNTP7633010  | SNTP7633013 |
|                    |  |           | € 22.787     | € 26.644    |
|                    | Heat exchanger<br>Wärmetauscher                  | Platinum  | SNTP1031010  | SNTP1031013 |
|                    |  | Porcelain | SNTP7631010  | SNTP7631013 |
|                    |  |           | € 23.664     | € 27.404    |

INSULATING COVER **to be included in the order** • WÄRMEABDECKUNG **Muss im Auftrag enthalten sein**

|  |          |     |           |
|--|----------|-----|-----------|
|  | PROVINYL | Ice | 903001482 |
|  |          |     | € 1.367   |

**NOTE:** Cover lifter not available • **HINWEIS:** Heber für Thermoabdeckung nicht verfügbar

ACCESSOIRES • ZUBEHÖRE

|  |   |                          |
|--|---|--------------------------|
|  | Winter Pro Kit  | 943613050                |
|  |   | € 1.099                  |
|  | Performance Kit · Sand not included<br>Sand ist nicht inklusive | 94428200                 |
|  |   | € 1.808                  |
|  | 1 x 25 kg bag of sand<br>1 Sack Sand 25 kg                      | 23320507                 |
|  |   | € 49                     |
| AISI 316 L frame • Rahmen aus AISI 316 L |   | on request • auf Anfrage |
|  |   | + € 1.000                |





**DELOS**

Design Kaluderovic & Condini



215 x 190 x 80 H cm

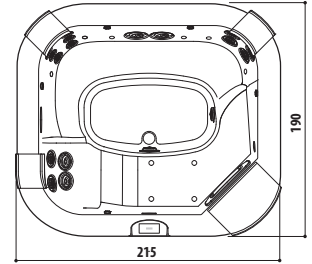

FEATURES • VERSIONEN

|  |  |    |
|--|--|----|
|  | Seats (total)<br>Sitzflächen (insgesamt)                               | 4  |
|  | Lounge   | 1  |
|  | Jets<br>Düsen  | 16 |
|  | Blowers  | 10 |
|  | Underwater LED multicolor light<br>Mehrfarbige Unterwasser-LED-Leuchte | ✓  |
|  | Cascade<br>Wasserfall  | ✓  |
|  | Removable headrests and cushion<br>Abnehmbare Kopfstütze und Kissen    | 4  |
|  | LCD control panel<br>LCD - Display                                     | ✓  |
|  | CLEARRAY® UV-C System  | ✓  |

|                    |  | BUILT-IN                  | FREESTANDING |             |             |
|--------------------|--|---------------------------|--------------|-------------|-------------|
| SKIRTING • PANEELE |  | FINISHING<br>AUSFÜHRUNGEN | TEAK         | GRAPHITE    |             |
|                    | 3 kW electric heater<br>3 kW elektrische Heizung | Platinum                  | DLSP1033010  | DLSP1033013 | DLSP1033014 |
|                    |  | Porcelain                 | DLSP7633010  | DLSP7633013 | DLSP7633014 |
|                    |  |                           | € 18.989     | € 22.087    |             |
|                    | Heat exchanger<br>Wärmetauscher                  | Platinum                  | DLSP1031010  | DLSP1031013 | DLSP1031014 |
|                    |  | Porcelain                 | DLSP7631010  | DLSP7631013 | DLSP7631014 |
|                    |  |                           | € 19.866     | € 22.905    |             |

INSULATING COVER **to be included in the order** • WÄRMEABDECKUNG **Muss im Auftrag enthalten sein**

|  |          |     |           |
|--|----------|-----|-----------|
|  | ProVinyl | Ice | 903001542 |
|  |          |     | € 1.129   |

**NOTE:** Cover lifter not available • **HINWEIS:** Heber für Thermoabdeckung nicht verfügbar

ACCESSOIRES • ZUBEHÖRE

|  |   |                          |
|--|---|--------------------------|
|  | Winter Pro Kit  | 943613060                |
|  |   | € 1.099                  |
|  | Performance Kit · Sand not included<br>Sand ist nicht inklusive | 94428200                 |
|  |   | € 1.808                  |
|  | 1 x 25 kg bag of sand<br>1 Sack Sand 25 kg                      | 23320507                 |
|  |   | € 49                     |
| AISI 316 L frame • Rahmen aus AISI 316 L |   | on request • auf Anfrage |
|  |   | + € 1.000                |



**DELFI**

Design Kaluderovic & Condini



190 x 190 x 80 H cm

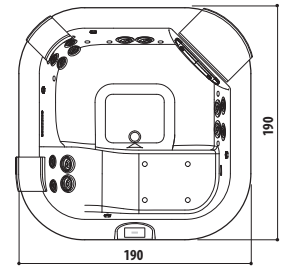

FEATURES • VERSIONEN

|  |  |    |
|--|--|----|
|  | Seats (total)<br>Sitzflächen (insgesamt)                               | 4  |
|  | Lounge   | 1  |
|  | Jets<br>Düsen  | 16 |
|  | Blowers  | 10 |
|  | Underwater LED multicolor light<br>Mehrfarbige Unterwasser-LED-Leuchte | ✓  |
|  | Cascade<br>Wasserfall  | ✓  |
|  | Removable headrests and cushion<br>Abnehmbare Kopfstütze und Kissen    | 3  |
|  | LCD control panel<br>LCD - Display                                     | ✓  |
|  | CLEARRAY® UV-C System  | ✓  |

|                    |  | BUILT-IN  | FREESTANDING |             |             |
|--------------------|--|-----------|--------------|-------------|-------------|
| SKIRTING • PANEELE |  | --        | TEAK         | GRAPHITE    |             |
|                    | 3 kW electric heater<br>3 kW elektrische Heizung | Platinum  | DLFP1033010  | DLFP1033013 | DLFP1033014 |
|                    |  | Porcelain | DLFP7633010  | DLFP7633013 | DLFP7633014 |
|                    |  | € 17.938  | € 20.918     |             |             |
|                    | Heat exchanger<br>Wärmetauscher                  | Platinum  | DLFP1031010  | DLFP1031013 | DLFP1031014 |
|                    |  | Porcelain | DLFP7631010  | DLFP7631013 | DLFP7631014 |
|                    |  | € 18.697  | € 21.736     |             |             |

INSULATING COVER to be included in the order • WÄRMEABDECKUNG Muss im Auftrag enthalten sein

|  |          |     |           |
|--|----------|-----|-----------|
|  | ProVinyl | Ice | 903001562 |
|  |          |     | € 1.063   |

**NOTE:** Cover lifter not available • **HINWEIS:** Heber für Thermoabdeckung nicht verfügbar

ACCESSOIRES • ZUBEHÖRE

|  |   |                          |
|--|---|--------------------------|
|  | Winter Pro Kit  | 943613070                |
|  |   | € 1.099                  |
|  | Performance Kit · Sand not included<br>Sand ist nicht inklusive | 94428200                 |
|  |   | € 1.808                  |
|  | 1 x 25 kg bag of sand<br>1 Sack Sand 25 kg                      | 23320507                 |
|  |   | € 49                     |
| AISI 316 L frame • Rahmen aus AISI 316 L |   | on request • auf Anfrage |
|  |   | + € 1.000                |



**UNIQVE**

Design Carlo Urbinati



190 x 150 x 80 H cm

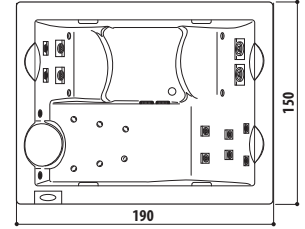
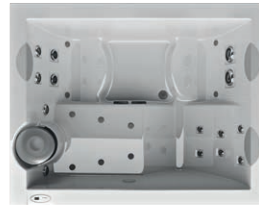

**FEATURES • VERSIONEN**

|  |  |           |
|--|--|-----------|
|  | Seats (total)<br>Sitzflächen (insgesamt)                               | <b>3</b>  |
|  | Lounge   | <b>1</b>  |
|  | Jets<br>Düsen  | <b>14</b> |
|  | Blowers  | <b>10</b> |
|  | Underwater LED multicolor light<br>Mehrfarbige Unterwasser-LED-Leuchte | <b>✓</b>  |
|  | Headrests<br>Kopfstütze  | <b>3</b>  |
|  | LED control panel<br>LED - Display                                     | <b>✓</b>  |
|  | CLEARRAY® UV-C System  | <b>✓</b>  |

|                    |  | BUILT-IN        | FREESTANDING    |             |
|--------------------|--|-----------------|-----------------|-------------|
| SKIRTING • PANEELE | FINISHING<br>AUSFÜHRUNGEN                        | --              | WHITE OAK       | GREY OAK    |
|                    | 2 kW electric heater<br>2 kW elektrische Heizung | UNQP1032010     | UNQP1032018     | UNQP1032019 |
|                    |  | UNQP7632010     | UNQP7632018     | UNQP7632019 |
|                    |  | <b>€ 14.549</b> | <b>€ 17.178</b> |             |

**INSULATING COVER to be included in the order • WÄRMEABDECKUNG Muss im Auftrag enthalten sein**

|  |          |     |              |
|--|----------|-----|--------------|
|  | ProVinyl | Ice | 903001682    |
|  |          |     | <b>€ 919</b> |

**NOTE:** Cover lifter not available • **HINWEIS:** Heber für Thermoabdeckung nicht verfügbar

**ACCESSOIRES • ZUBEHÖRE**

|  |   |                          |
|--|---|--------------------------|
|  | Winter Pro Kit  | 943613040                |
|  |   | <b>€ 1.099</b>           |
|  | Performance Kit · Sand not included<br>Sand ist nicht inklusive | 94428200                 |
|  |   | <b>€ 1.808</b>           |
|  | 1 x 25 kg bag of sand<br>1 Sack Sand 25 kg                      | 23320507                 |
|  |   | <b>€ 49</b>              |
| AISI 316 L frame • Rahmen aus AISI 316 L |   | on request • auf Anfrage |
|  |   | <b>+ € 1.000</b>         |





# CITY™ SPA

Design Kaluderovic & Condini

150 x 160 x 75 H cm

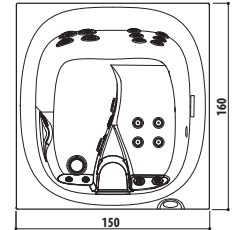

## FEATURES • VERSIONEN

|  |  |    |
|--|--|----|
|  | Seats (total)<br>Sedute (totali)                                       | 2  |
|  | Lounge   | 2  |
|  | Jets<br>Düsen  | 20 |
|  | Underwater LED multicolor light<br>Mehrfarbige Unterwasser-LED-Leuchte | ✓  |
|  | LED control panel<br>LED - Display                                     | ✓  |
|  | CLEARRAY® UV-C system  | ✓  |

|  |                           | BUILT-IN    | FREESTANDING |             |
|--|---------------------------|-------------|--------------|-------------|
| SKIRTING • PANEEL                                    | FINISHING<br>AUSFÜHRUNGEN | --          | WHITE OAK    | GREY OAK    |
| 1,5 kW electric heater<br>1,5 kW elektrische Heizung | Platinum                  | CITP1026010 | CITP1026018  | CITP1026019 |
|  | Porcelain                 | CITP7626010 | CITP7626018  | CITP7626019 |
|  |                           | € 12.738    | € 14.023     |             |
| 2 kW electric heater<br>2 kW elektrische Heizung     | Platinum                  | CITP1022010 | CITP1022018  | CITP1022019 |
|  | Porcelain                 | CITP7622010 | CITP7622018  | CITP7622019 |
|  |                           | € 12.738    | € 14.023     |             |

## INSULATING COVER to be included in the order • WÄRMEABDECKUNG **Muss im Auftrag enthalten sein**

|  |          |     |           |
|--|----------|-----|-----------|
|  | ProVinyl | Ice | 903001732 |
|  |          |     | € 851     |

**NOTE:** Cover lifter not available • **HINWEIS:** Heber für Thermoabdeckung nicht verfügbar

## ACCESSOIRES • ZUBEHÖRE

|  |  |                          |
|--|--|--------------------------|
|  | Winter Pro Kit                           | 943613080                |
|  |  | € 806                    |
|  | AISI 316 L frame • Rahmen aus AISI 316 L | on request • auf Anfrage |
|  |  | + € 1.000                |



# ALIMIA

Design Jacuzzi®



Ø 212 x 90 H cm

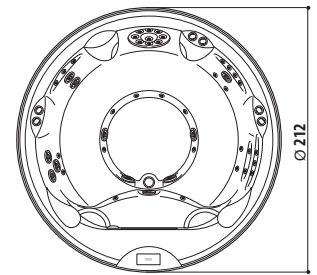

## FEATURES • VERSIONEN

|  |  |     |
|--|--|-----|
|  | Seats (total)<br>Sitzflächen (insgesamt) | 5-6 |
|  | Jets<br>Düsen                            | 28  |
|  | Blowers                                  | 12  |
|  | Light System - Multicolour               | ✓   |
|  | LCD control panel<br>LCD - Display       | ✓   |
|  | CLEARRAY® UV-C System                    | ✓   |

|                   |  | BUILT-IN  | FREESTANDING |
|-------------------|--|-----------|--------------|
| SKIRTING • PANEEL | FINISHING<br>AUSFÜHRUNGEN                        | --        | GRAPHITE     |
|                   | 3 kW electric heater<br>3 kW elektrische Heizung | 944468065 | 944513465    |
|                   |  | 944468052 | 944513452    |
|                   |  | 944468097 | 944513497    |
|                   |  | € 21.401  | € 25.101     |

## INSULATING COVER to be included in the order • WÄRMEABDECKUNG Muss im Auftrag enthalten sein

|  |          |     |           |
|--|----------|-----|-----------|
|  | ProVinyl | Ice | 903001672 |
|  |          |     | € 1.137   |

**NOTE:** Cover lifter not available • **HINWEIS:** Heber für Thermoabdeckung nicht verfügbar

## ACCESSOIRES • ZUBEHÖRE

|  |                |                          |
|--|----------------|--------------------------|
|  | Winter Pro Kit | 943613260                |
|  |                | € 1.099                  |
| AISI 316 L frame • Rahmen aus AISI 316 L |                | on request • auf Anfrage |
|  |                | + € 1.000                |





UNIQUE



*Jacuzzi*®





LODGE+ COLLECTION





FEATURES • VERSIONEN

|  |  | LODGE+ S                      | LODGE+ M           | LODGE+ L           |
|--|--|-------------------------------|--------------------|--------------------|
|  | Dimensions<br>Abmessungen  | 185 x 165 x 90H cm            | 200 x 185 x 90H cm | 211 x 223 x 90H cm |
|  | Seats (total)<br>Sitzflächen (insgesamt)   | <b>2-3</b>                    | <b>4-5</b>         | <b>5-6</b>         |
|  | Lounge   | <b>1</b>                      |                    | <b>1</b>           |
|  | Jets<br>Düsen  | <b>16</b>                     | <b>20</b>          | <b>24</b>          |
|  | Blowers  | <b>10</b>                     | <b>12</b>          | <b>14</b>          |
|  | Underwater LED multicolor light<br>Mehrfarbige Unterwasser-LED-Leuchte                       |                               | ✓                  |                    |
|  | LED control panel<br>LED - Display   |                               | <b>1</b>           |                    |
|  | Back-lit touch control<br>Rückseitig beleuchtetes Touch-Bedienelement                        |                               | <b>1</b>           |                    |
|  | CLEARRAY® UV   |                               | ✓                  |                    |
|  | Eco shield insulation<br>Eco Shield-Isolierung   |                               | ○                  |                    |
|  | Skirting<br>Paneele  | SILVERWOOD • ROASTED CHESTNUT |                    |                    |
|  | Electric heater (2 kW) and circulation pump<br>Elektrisches heizgerät (2 kW) und umwälzpumpe | ○                             |                    |                    |
|  | Electric heater (3 kW) and circulation pump<br>Elektrisches heizgerät (3 kW) und umwälzpumpe |                               | ○                  | ○                  |
|  | Heat exchanger<br>Wärmetauscher  |                               | ○                  |                    |
|  | Quick drain<br>Quick drain (Schnelle Entleerung)   |                               | ✓                  |                    |

✓ Standard      ○ Depending on the version

**NOTE: Do not use sea water or water with added salt on all Hot Tub and Swim Spa models.**

✓ Serienmäßig      ○ Seriemiässig je nach gewählter Ausführung

**HINWEIS: Alle Hot Tub- und Swim Spa-Modelle nicht mit Meerwasser oder mit zugesetztem Salz verwenden.**





# LODGE+ L

Design Jacuzzi®  
211 x 223 x 90 H cm



Drawing shows the HYDRO version  
Bild zeigt die HYDRO-Version

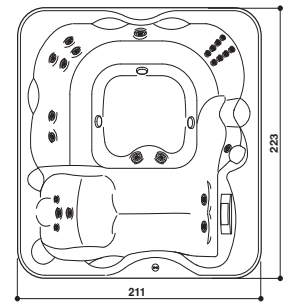

| HYDRO   |                           |             |              |                  |
|---|---------------------------|-------------|--------------|------------------|
|   |                           | BUILT-IN    | FREESTANDING |                  |
| INSULATION • ISOLIERUNG                             |                           | --          | ECO SHIELD   |                  |
| SKIRTING • PANEELE                                  | FINISHING<br>AUSFÜHRUNGEN | --          | SILVERWOOD   | ROASTED CHESTNUT |
| Electric heater 3 kW<br>Elektrisches Heizgerät 3 kW | Platinum                  | LODL1023010 | LODL1023311  | LODL1023312      |
|   | Porcelain                 | LODL0023010 | LODL0023311  | LODL0023312      |
|   |                           | € 9.996     | € 12.428     |                  |
| Heat exchanger<br>Wärmetauscher                     | Platinum                  | LODL1021010 | LODL1021311  | LODL1021312      |
|   | Porcelain                 | LODL0021010 | LODL0021311  | LODL0021312      |
|   |                           | € 10.204    | € 12.635     |                  |

| HYDRO + BLOWER                                      |                           |             |              |                  |
|---|---------------------------|-------------|--------------|------------------|
|   |                           | BUILT-IN    | FREESTANDING |                  |
| INSULATION • ISOLIERUNG                             |                           | --          | ECO SHIELD   |                  |
| SKIRTING • PANEELE                                  | FINISHING<br>AUSFÜHRUNGEN | --          | SILVERWOOD   | ROASTED CHESTNUT |
| Electric heater 3 kW<br>Elektrisches Heizgerät 3 kW | Platinum                  | LODL1033010 | LODL1033311  | LODL1033312      |
|   | Porcelain                 | LODL0033010 | LODL0033311  | LODL0033312      |
|   |                           | € 10.726    | € 13.157     |                  |
| Heat exchanger<br>Wärmetauscher                     | Platinum                  | LODL1031010 | LODL1031311  | LODL1031312      |
|   | Porcelain                 | LODL0031010 | LODL0031311  | LODL0031312      |
|   |                           | € 10.933    | € 13.363     |                  |

| INSULATING COVER to be included in the order • WÄRMEABDECKUNG Muss im Auftrag enthalten sein |             |           |  |  |
|--|-------------|-----------|--|--|
| ProVinyl   | Grey • Grau | 903001972 |  |  |
|  |             | € 1.286   |  |  |

| ACCESSOIRES • ZUBEHÖRE  |                  |                          |  |  |
|---|------------------|--------------------------|--|--|
| Performance Kit · Sand not included<br>Sand ist nicht inklusive     | 94428200         |                          |  |  |
|   | € 1.808          |                          |  |  |
| 1 x 25 kg bag of sand<br>1 Sack Sand 25 kg                          | 23320507         |                          |  |  |
|   | € 49             |                          |  |  |
| Cover lifter undermount manual<br>Manueller Lift für Wärmeabdeckung | 890011500        |                          |  |  |
|   | € 865            |                          |  |  |
| Smart Step - 2 steps<br>Smart Step - zweistufig                     | Black<br>Schwarz | 890011600                |  |  |
|   |                  | € 526                    |  |  |
| AISI 316 L frame • Rahmen aus AISI 316 L                            |                  | on request • auf Anfrage |  |  |
|   |                  | + € 1.000                |  |  |



# LODGE+ M

Design Jacuzzi®

200 x 185 x 90 H cm



Drawing shows the HYDRO version  
Bild zeigt die HYDRO-Version

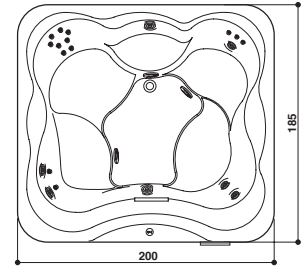

| HYDRO   |                        |             |              |                  |
|---|------------------------|-------------|--------------|------------------|
|   |                        | BUILT-IN    | FREESTANDING |                  |
| INSULATION • ISOLIERUNG                             |                        | --          | ECO SHIELD   |                  |
| SKIRTING • PANEELE                                  | FINISHING AUSFÜHRUNGEN | --          | SILVERWOOD   | ROASTED CHESTNUT |
| Electric heater 3 kW<br>Elektrisches Heizgerät 3 kW | Platinum               | LODM1023010 | LODM1023311  | LODM1023312      |
|   | Porcelain              | LODM0023010 | LODM0023311  | LODM0023312      |
|   |                        | € 9.212     | € 11.642     |                  |
| Heat exchanger<br>Wärmetauscher                     | Platinum               | LODM1021010 | LODM1021311  | LODM1021312      |
|   | Porcelain              | LODM0021010 | LODM0021311  | LODM0021312      |
|   |                        | € 9.419     | € 11.848     |                  |

| HYDRO + BLOWER                                      |                        |             |              |                  |
|---|------------------------|-------------|--------------|------------------|
|   |                        | BUILT-IN    | FREESTANDING |                  |
| INSULATION • ISOLIERUNG                             |                        | --          | ECO SHIELD   |                  |
| SKIRTING • PANEELE                                  | FINISHING AUSFÜHRUNGEN | --          | SILVERWOOD   | ROASTED CHESTNUT |
| Electric heater 3 kW<br>Elektrisches Heizgerät 3 kW | Platinum               | LODM1033010 | LODM1033311  | LODM1033312      |
|   | Porcelain              | LODM0033010 | LODM0033311  | LODM0033312      |
|   |                        | € 9.869     | € 12.299     |                  |
| Heat exchanger<br>Wärmetauscher                     | Platinum               | LODM1031010 | LODM1031311  | LODM1031312      |
|   | Porcelain              | LODM0031010 | LODM0031311  | LODM0031312      |
|   |                        | € 10.075    | € 12.506     |                  |

| INSULATING COVER to be included in the order • WÄRMEABDECKUNG Muss im Auftrag enthalten sein |             |           |  |  |
|--|-------------|-----------|--|--|
| ProVinyl   | Grey • Grau | 903001902 |  |  |
|  |             | € 1.141   |  |  |

| ACCESSOIRES • ZUBEHÖRE  |                  |                          |  |  |
|---|------------------|--------------------------|--|--|
| Performance Kit · Sand not included<br>Sand ist nicht inklusive     | 94428200         |                          |  |  |
|   | € 1.808          |                          |  |  |
| 1 x 25 kg bag of sand<br>1 Sack Sand 25 kg                          | 23320507         |                          |  |  |
|   | € 49             |                          |  |  |
| Cover lifter undermount manual<br>Manueller Lift für Wärmeabdeckung | 890011500        |                          |  |  |
|   | € 865            |                          |  |  |
| Smart Step - 2 steps<br>Smart Step - zweistufig                     | Black<br>Schwarz | 890011600                |  |  |
|   |                  | € 526                    |  |  |
| AISI 316 L frame • Rahmen aus AISI 316 L                            |                  | on request • auf Anfrage |  |  |
|   |                  | + € 1.000                |  |  |



# LODGE+ S

Design Jacuzzi®

185 x 165 x 90 H cm



Drawing shows the HYDRO version  
Bild zeigt die HYDRO-Version

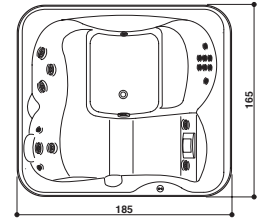

| HYDRO   |                        |             |              |                  |
|---|------------------------|-------------|--------------|------------------|
|   |                        | BUILT-IN    | FREESTANDING |                  |
| INSULATION • ISOLIERUNG                             |                        | --          | ECO SHIELD   |                  |
| SKIRTING • PANEELE                                  | FINISHING AUSFÜHRUNGEN | --          | SILVERWOOD   | ROASTED CHESTNUT |
| Electric heater 2 kW<br>Elektrisches Heizgerät 2 kW | Platinum               | LODS1022010 | LODS1022311  | LODS1022312      |
|   | Porcelain              | LODS0022010 | LODS0022311  | LODS0022312      |
|   |                        | € 8.405     | € 10.472     |                  |
| Heat exchanger<br>Wärmetauscher                     | Platinum               | LODS1021010 | LODS1021311  | LODS1021312      |
|   | Porcelain              | LODS0021010 | LODS0021311  | LODS0021312      |
|   |                        | € 8.611     | € 10.676     |                  |

| HYDRO + BLOWER                                      |                        |             |              |                  |
|---|------------------------|-------------|--------------|------------------|
|   |                        | BUILT-IN    | FREESTANDING |                  |
| INSULATION • ISOLIERUNG                             |                        | --          | ECO SHIELD   |                  |
| SKIRTING • PANEELE                                  | FINISHING AUSFÜHRUNGEN | --          | SILVERWOOD   | ROASTED CHESTNUT |
| Electric heater 2 kW<br>Elektrisches Heizgerät 2 kW | Platinum               | LODS1032010 | LODS1032311  | LODS1032312      |
|   | Porcelain              | LODS0032010 | LODS0032311  | LODS0032312      |
|   |                        | € 9.036     | € 11.103     |                  |
| Heat exchanger<br>Wärmetauscher                     | Platinum               | LODS1031010 | LODS1031311  | LODS1031312      |
|   | Porcelain              | LODS0031010 | LODS0031311  | LODS0031312      |
|   |                        | € 9.243     | € 11.310     |                  |

| INSULATING COVER to be included in the order • WÄRMEABDECKUNG Muss im Auftrag enthalten sein |             |           |  |  |
|--|-------------|-----------|--|--|
| ProVinyl   | Grey • Grau | 903001982 |  |  |
|  |             | € 911     |  |  |

| ACCESSOIRES • ZUBEHÖRE  |                  |                          |  |  |
|---|------------------|--------------------------|--|--|
| Performance Kit · Sand not included<br>Sand ist nicht inklusive     | 94428200         |                          |  |  |
|   | € 1.808          |                          |  |  |
| 1 x 25 kg bag of sand<br>1 Sack Sand 25 kg                          | 23320507         |                          |  |  |
|   | € 49             |                          |  |  |
| Cover lifter undermount manual<br>Manueller Lift für Wärmeabdeckung | 890011500        |                          |  |  |
|   | € 865            |                          |  |  |
| Smart Step - 2 steps<br>Smart Step - zweistufig                     | Black<br>Schwarz | 890011600                |  |  |
|   |                  | € 526                    |  |  |
| AISI 316 L frame • Rahmen aus AISI 316 L                            |                  | on request • auf Anfrage |  |  |
|   |                  | + € 1.000                |  |  |



*Jacuzzi*®





PROFESSIONAL COLLECTION



VIRTUS PRO





# VIRTUS PRO

Design Dodo Arslan & Jacuzzi® Design



250 x 215 x 93 H cm

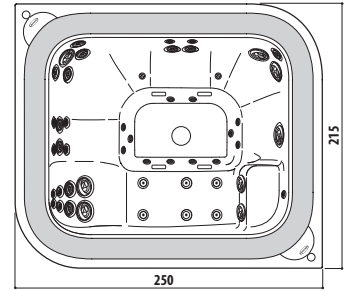

## FEATURES • VERSIONEN

|  |   | BUILT-IN  |             |
|--|---|-----------|-------------|
|  | Seats • Sitzflächen   | 6-7       |             |
|  | Lounge  | 1         |             |
|  | Jets • Düsen  | 50        |             |
|  | Underwater LED multicolor light • Mehrfarbige Unterwasser-LED-Leuchte | 2         |             |
|  | LED control panel • LED - Display                                     | 1         |             |
|  | Back-lit touch controls • Rückseitig beleuchtetes Touch-Bedienelement | 2         |             |
|  | Automatic water fill-up • Automatische Wasserbefüllung                | ✓         |             |
|  | Quick drain • Quick drain (Schnelle Entleerung)                       | ✓         |             |
|  | Without standard compensation tank<br>Ohne Überlauf tank              | Porcelain | VIRP0020000 |
|  |   | Platinum  | VIRP1020000 |
|  |   | € 18.055  |             |

## COMPENSATION TANKS - ÜBERLAUFTANK

|  |   |           |
|--|---|-----------|
|  | Low compensation tank<br>Mit herabgesetztem Überlauf tank | 423630020 |
|  |   | € 3.238   |
|  | Standard compensation tank<br>Mit Standard-Überlauf tank  | 423630012 |
|  |   | € 1.829   |

## INSULATING COVER to be included in the order • WÄRMEABDECKUNG Muss im Auftrag enthalten sein

|  |          |     |           |
|--|----------|-----|-----------|
|  | ProVinyl | Ice | 903002472 |
|  |          |     | € 2.090   |

**NOTE:** Cover lifter not available • **HINWEIS:** Heber für Thermoabdeckung nicht verfügbar

## SPA PACK

|  |                               | EUROPEAN STANDARD 220/240V F+N - OTHERS 380/415V 3F+N |                    |
|--|-------------------------------|---|--------------------|
|  | Without heater • Ohne Heizung | 94428780  |                    |
|  |                               | € 5.387   |                    |
|  | With heater • Mit Heizung     | 94428790  |                    |
|  | 3 kW                          | € 5.653   |                    |
|  | Exchanger • Wärmetauscher     | 94428800  |                    |
|  |                               | € 6.050   |                    |
|  |                               | EUROPEAN STANDARD 380/415V 3F+N                       | OTHERS 220/240V 3F |
|  | Without heater • Ohne Heizung | 94428100  | 94427100           |
|  |                               | € 6.528   |                    |
|  | With heater • Mit Heizung     | 94428101  | 94427101           |
|  | 12 kW                         | € 7.519   |                    |
|  | Exchanger • Wärmetauscher     | 94428102  | 94427102           |
|  |                               | € 7.050   |                    |

## ACCESSOIRES • ZUBEHÖRE

|  |  |                          |
|--|--|--------------------------|
|  | Ozone generator<br>Ozongenerator         | 94360040                 |
|  |  | € 858                    |
|  | AISI 316 L frame • Rahmen aus AISI 316 L | on request • auf Anfrage |
|  |  | + € 1.000                |





# ENJOY PRO

Design Kaluderovic & Condini



250 x 250 x 98 H cm

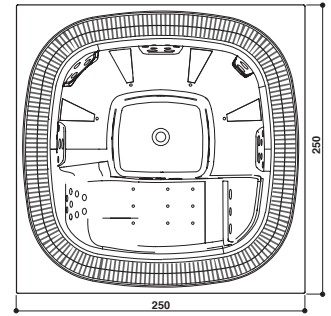

## FEATURES • VERSIONEN

|  |   | BUILT-IN  |           |
|--|---|-----------|-----------|
|  | Seats • Sitzflächen   | 6         |           |
|  | Lounge  | 1         |           |
|  | Jets • Düsen  | 38        |           |
|  | Blowers   | 15        |           |
|  | Underwater LED multicolor light • Mehrfarbige Unterwasser-LED-Leuchte | 2         |           |
|  | Automatic water fill-up • Automatische Wasserbefüllung                | ✓         |           |
|  | Quick drain • Quick drain (Schnelle Entleerung)                       | ✓         |           |
|  | Without standard compensation tank<br>Ohne Überlauf tank              | Porcelain | 944503052 |
|  |   | Platinum  | 944503065 |
|  |   | Cobalt    | 944503097 |
|  |   |           | € 14.195  |

## COMPENSATION TANKS - ÜBERLAUFTANK

|  |   |           |
|--|---|-----------|
|  | Low compensation tank<br>Mit herabgesetztem Überlauf tank | 423630020 |
|  |   | € 3.238   |
|  | Standard compensation tank<br>Mit Standard-Überlauf tank  | 423630012 |
|  |   | € 1.829   |

## INSULATING COVER to be included in the order • WÄRMEABDECKUNG Muss im Auftrag enthalten sein

|  |          |     |           |
|--|----------|-----|-----------|
|  | ProVinyl | Ice | 903001872 |
|  |          |     | € 1.594   |

**NOTE:** Cover lifter not available • **HINWEIS:** Heber für Thermoabdeckung nicht verfügbar

## SPA PACK

|  |                               | EUROPEAN STANDARD 220/240V F+N - OTHERS 380/415V 3F+N |                    |
|--|-------------------------------|---|--------------------|
|  | Without heater • Ohne Heizung | 94428730  |                    |
|  |                               | € 7.468   |                    |
|  | With heater • Mit Heizung     | 94428710  |                    |
|  | 3 kW                          | € 7.903   |                    |
|  | Exchanger • Wärmetauscher     | 94428720  |                    |
|  |                               | € 8.339   |                    |
|  |                               | EUROPEAN STANDARD 380/415V 3F+N                       | OTHERS 220/240V 3F |
|  | Without heater • Ohne Heizung | 94428400  | 94427400           |
|  |                               | € 7.956   |                    |
|  | With heater • Mit Heizung     | 94428401  | 94427401           |
|  | 12 kW                         | € 9.596   |                    |
|  | Exchanger • Wärmetauscher     | 94428402  | 94427402           |
|  | € 9.676                       |   |                    |

## ACCESSOIRES • ZUBEHÖRE

|  |  |                          |
|--|--|--------------------------|
|  | Ozone generator<br>Ozongenerator         | 94360040                 |
|  |  | € 858                    |
|  | AISI 316 L frame • Rahmen aus AISI 316 L | on request • auf Anfrage |
|  |  | + € 1.000                |



# VIRGINIA PRO

Jacuzzi® Design



257 x 219 x 98 H cm

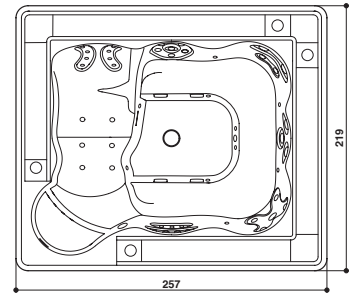
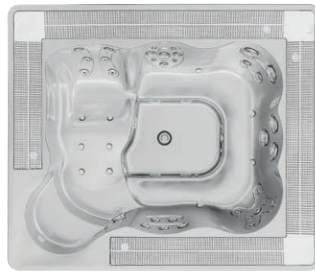

## FEATURES • VERSIONEN

|  |   | BUILT-IN   |                 |
|--|---|------------|-----------------|
|  | Seats • Sitzflächen   | <b>6-7</b> |                 |
|  | Lounge  | <b>1</b>   |                 |
|  | Jets • Düsen  | <b>34</b>  |                 |
|  | Blowers   | <b>16</b>  |                 |
|  | Underwater LED multicolor light • Mehrfarbige Unterwasser-LED-Leuchte | ✓          |                 |
|  | Automatic water fill-up • Automatische Wasserbefüllung                | ✓          |                 |
|  | Quick drain • Quick drain (Schnelle Entleerung)                       | ✓          |                 |
|  | Without standard compensation tank<br>Ohne Überlauf tank              | Porcelain  | 944411652       |
|  |   | Platinum   | 944411665       |
|  |   | Cobalt     | 944411697       |
|  |   |            | <b>€ 16.824</b> |

## COMPENSATION TANKS - ÜBERLAUFTANK

|  |   |                |
|--|---|----------------|
|  | Low compensation tank<br>Mit herabgesetztem Überlauf tank | 423630020      |
|  |   | <b>€ 3.238</b> |
|  | Standard compensation tank<br>Mit Standard-Überlauf tank  | 423630012      |
|  |   | <b>€ 1.829</b> |

## INSULATING COVER to be included in the order • WÄRMEABDECKUNG Muss im Auftrag enthalten sein

|  |          |     |                |
|--|----------|-----|----------------|
|  | ProVinyl | Ice | 903001652      |
|  |          |     | <b>€ 1.357</b> |

**NOTE:** Cover lifter not available • **HINWEIS:** Heber für Thermoabdeckung nicht verfügbar

## SPA PACK

|  |                               | EUROPEAN STANDARD 220/240V F+N - OTHERS 380/415V 3F+N |                    |
|--|-------------------------------|---|--------------------|
|  | Without heater • Ohne Heizung | 94428730  |                    |
|  |                               | <b>€ 7.468</b>  |                    |
|  | With heater • Mit Heizung     | 94428710  |                    |
|  | 3 kW                          | <b>€ 7.903</b>  |                    |
|  | Exchanger • Wärmetauscher     | 94428720  |                    |
|  |                               | <b>€ 8.339</b>  |                    |
|  |                               | EUROPEAN STANDARD 380/415V 3F+N                       | OTHERS 220/240V 3F |
|  | Without heater • Ohne Heizung | 94428400  | 94427400           |
|  |                               | <b>€ 7.956</b>  |                    |
|  | With heater • Mit Heizung     | 94428401  | 94427401           |
|  | 12 kW                         | <b>€ 9.596</b>  |                    |
|  | Exchanger • Wärmetauscher     | 94428402  | 94427402           |
|  | <b>€ 9.676</b>                |   |                    |

## ACCESSOIRES • ZUBEHÖRE

|  |  |                          |
|--|--|--------------------------|
|  | Ozone generator<br>Ozongenerator         | 94360040                 |
|  |  | <b>€ 858</b>             |
|  | AlSi 316 L frame • Rahmen aus AlSi 316 L | on request • auf Anfrage |
|  |  | <b>+ € 1.000</b>         |





# SIENNA PRO

Jacuzzi® Design



257 x 219 x 98 H cm

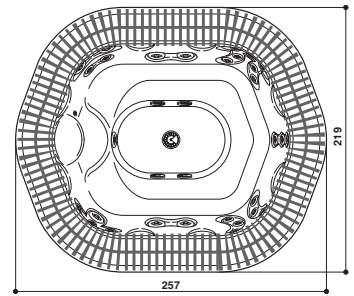

## FEATURES • VERSIONEN

|  |   | BUILT-IN  |           |
|--|---|-----------|-----------|
|  | Seats • Sitzflächen   | 7-8       |           |
|  | Jets • Düsen  | 30        |           |
|  | Blowers   | 16        |           |
|  | Underwater LED multicolor light • Mehrfarbige Unterwasser-LED-Leuchte | ✓         |           |
|  | Automatic water fill-up • Automatische Wasserbefüllung                | ✓         |           |
|  | Quick drain • Quick drain (Schnelle Entleerung)                       | ✓         |           |
|  | Without standard compensation tank<br>Ohne Überlauf tank              | Porcelain | 944411752 |
|  |   | Platinum  | 944411765 |
|  |   | Cobalt    | 944411797 |
|  |   |           | € 15.209  |

## COMPENSATION TANKS - ÜBERLAUFTANK

|  |   |           |
|--|---|-----------|
|  | Low compensation tank<br>Mit herabgesetztem Überlauf tank | 423630020 |
|  |   | € 3.238   |
|  | Standard compensation tank<br>Mit Standard-Überlauf tank  | 423630012 |
|  |   | € 1.829   |

## INSULATING COVER to be included in the order • WÄRMEABDECKUNG Muss im Auftrag enthalten sein

|  |          |     |           |
|--|----------|-----|-----------|
|  | ProVinyl | Ice | 903001662 |
|  |          |     | € 1.274   |

**NOTE:** Cover lifter not available • **HINWEIS:** Heber für Thermoabdeckung nicht verfügbar

## SPA PACK

|                           |                               |       | EUROPEAN STANDARD 220/240V F+N - OTHERS 380/415V 3F+N |                    |
|---------------------------|-------------------------------|-------|---|--------------------|
|                           | Without heater • Ohne Heizung |       | 94428730  |                    |
|                           |                               |       | € 7.468   |                    |
|                           | With heater • Mit Heizung     | 3 kW  | 94428710  |                    |
|                           |                               |       | € 7.903   |                    |
| Exchanger • Wärmetauscher |                               |       | 94428720  |                    |
|                           |                               |       | € 8.339   |                    |
|                           |                               |       | EUROPEAN STANDARD 380/415V 3F+N                       | OTHERS 220/240V 3F |
|                           | Without heater • Ohne Heizung |       | 94428400  | 94427400           |
|                           |                               |       | € 7.956   |                    |
|                           | With heater • Mit Heizung     | 12 kW | 94428401  | 94427401           |
|                           |                               |       | € 9.596   |                    |
| Exchanger • Wärmetauscher |                               |       | 94428402  | 94427402           |
|                           |                               |       | € 9.676   |                    |

## ACCESSOIRES • ZUBEHÖRE

|  |                                  |                          |
|--|----------------------------------|--------------------------|
|  | Ozone generator<br>Ozongenerator | 94360040                 |
|  |                                  | € 858                    |
| AISI 316 L frame • Rahmen aus AISI 316 L |                                  | on request • auf Anfrage |
|  |                                  | + € 1.000                |

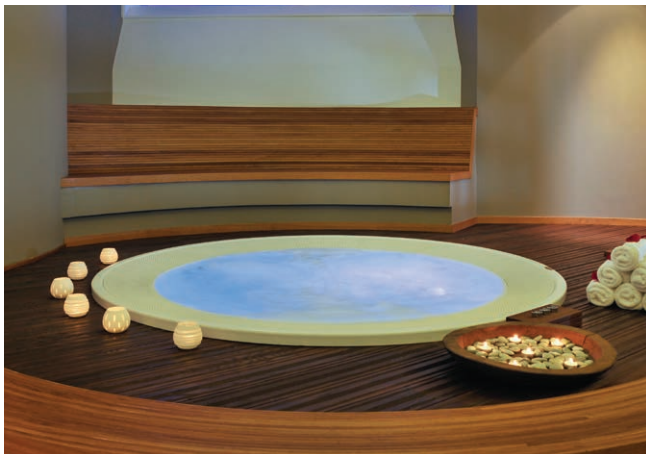

# ALIMIA PRO

Jacuzzi® Design



Ø 237 x 98 H cm

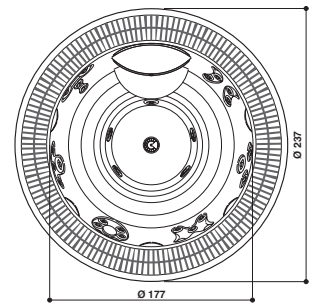

## FEATURES • VERSIONEN

|  |   | BUILT-IN  |           |
|--|---|-----------|-----------|
|  | Seats • Sitzflächen   | 6-7       |           |
|  | Jets • Düsen  | 28        |           |
|  | Blowers   | 16        |           |
|  | Underwater LED multicolor light • Mehrfarbige Unterwasser-LED-Leuchte | ✓         |           |
|  | Automatic water fill-up • Automatische Wasserbefüllung                | ✓         |           |
|  | Quick drain • Quick drain (Schnelle Entleerung)                       | ✓         |           |
|  | Without standard compensation tank<br>Ohne Überlauf tank              | Porcelain | 944411852 |
|  |   | Platinum  | 944411865 |
|  |   | Cobalt    | 944411897 |
|  |   |           | € 16.051  |

## COMPENSATION TANKS - ÜBERLAUFTANK

|  |   |           |
|--|---|-----------|
|  | Low compensation tank<br>Mit herabgesetztem Überlauf tank | 423630020 |
|  |   | € 3.238   |
|  | Standard compensation tank<br>Mit Standard-Überlauf tank  | 423630012 |
|  |   | € 1.829   |

## INSULATING COVER to be included in the order • WÄRMEABDECKUNG Muss im Auftrag enthalten sein

|  |          |     |           |
|--|----------|-----|-----------|
|  | ProVinyl | Ice | 903001712 |
|  |          |     | € 1.274   |

**NOTE:** Cover lifter not available • **HINWEIS:** Heber für Thermoabdeckung nicht verfügbar

## SPA PACK

|                           |                               | EUROPEAN STANDARD 220/240V F+N - OTHERS 380/415V 3F+N |                    |          |
|---------------------------|-------------------------------|---|--------------------|----------|
|                           | Without heater • Ohne Heizung |   | 94428730           |          |
|                           |                               |   | € 7.468            |          |
|                           | With heater • Mit Heizung     | 3 kW  | 94428710           |          |
|                           |                               |   | € 7.903            |          |
| Exchanger • Wärmetauscher |                               | 94428720  |                    |          |
|                           |                               | € 8.339   |                    |          |
|                           |                               | EUROPEAN STANDARD 380/415V 3F+N                       | OTHERS 220/240V 3F |          |
|                           | Without heater • Ohne Heizung |   | 94428400           | 94427400 |
|                           |                               |   | € 7.956            |          |
|                           | With heater • Mit Heizung     | 12 kW   | 94428401           | 94427401 |
|                           |                               |   | € 9.596            |          |
| Exchanger • Wärmetauscher |                               | 94428402  | 94427402           |          |
|                           |                               | € 9.676   |                    |          |

## ACCESSOIRES • ZUBEHÖRE

|  |                                  |                          |
|--|----------------------------------|--------------------------|
|  | Ozone generator<br>Ozongenerator | 94360040                 |
|  |                                  | € 858                    |
| AISI 316 L frame • Rahmen aus AISI 316 L |                                  | on request • auf Anfrage |
|  |                                  | + € 1.000                |





VIRTUS PRO



ALIMIA PRO

Golfo dei poeti Relais & Spa, Italia



# Jacuzzi®





SWIM SPA COLLECTION



J-19 POWER PRO



# J-19 PowerPro™

Design Jacuzzi®



564 x 236 x 134 H cm

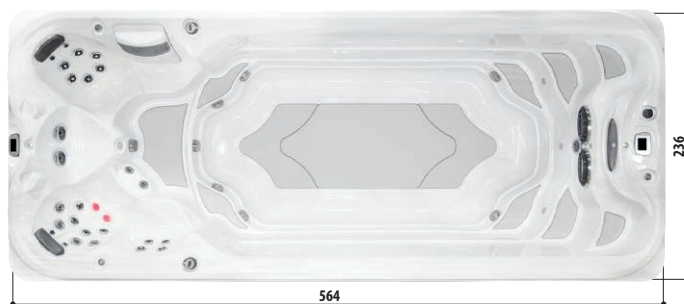

## FEATURES • VERSIONEN

|            |   |    |
|------------|---|----|
|            | PowerPro® Swim PX Jets • Düsen PowerPro® Swim PX  | 2  |
|            | Buoyancy Jet • Schwebedüse  | 1  |
|            | Jets • Düsen  | 26 |
| <b>new</b> | IR and Red Lights • Infrarotlampen und rotes Licht  | 2  |
|            | Swim Selector Control • Kommando Swim Selector  | 2  |
|            | Hydromassage seats • Sitzflächen des Whirlpools   | 4  |
|            | SmartTub®   | ✓  |
|            | Smart Swim Goggles • Schwimmbrille FORM   | ✓  |
|            | WaterColour™ Waterfall • WaterColour™ Wasserfall  | ✓  |
|            | With Stainless Steel Exercise Bar 120 cm (factory fitted, left side only)<br>Trainingsstange aus Edelstahl 120 cm (nur linke Seite - vormontiert) | ✓  |
|            | Elastic cable with belt for static swimming<br>Elastisches Band mit Gurt für stationäres Schwimmen  | ✓  |
|            | Light System LED Multicolour<br>Mehrfarbige Unterwasser-LED-Leuchte   | ✓  |
|            | CLEARWAY Active Oxygen™ Low output ozone generator + UV-C<br>Ozongenerator mit geringer Emission + UV-C   | ✓  |
|            | Pillow headrest • Kopfstütze  | 2  |
|            | Perma insulated floor • Boden mit Wärmeisolierung   | ✓  |
|            | Double electric heater • Doppeltes elektrisches Heizgerät   | ✓  |
|            | By-pass for auxiliary heating • Bypass für Zusatzheizung  | ✓  |

|                    |   | BUILT-IN               | FREESTANDING |                 |              |
|--------------------|---|------------------------|--------------|-----------------|--------------|
| SKIRTING • PANELEE |   | FINISHING AUSFÜHRUNGEN | BRUSHED GREY | MODERN HARDWOOD | SMOKED EBONY |
|                    | With Stainless Steel Exercise Bar 120 cm (factory fitted, left side only)<br>Trainingsstange aus Edelstahl 120 cm (nur linke Seite - vormontiert) | Porcelain              | SC76300ENHXM | SC76300ENHXM    | SC76300ENHXM |
|                    |   | Platinum               | SC12300ENHXM | SC12300ENHXM    | SC12300ENHXM |
|                    |   | Silver Pearl           | SC33300ENHXM | SC33300ENHXM    | SC33300ENHXM |
|                    |   |                        | € 46.594     | € 49.905        |              |

## INSULATING COVER to be included in the order • WÄRMEABDECKUNG Muss im Auftrag enthalten sein

|  |   |                  |           |         |
|--|---|------------------|-----------|---------|
|  | Rigid thermal cover in 5 parts<br>Starre 5-teilige Wärmeabdeckung | ProLast® Grigio  | 903003440 | € 2.447 |
|  |   | ProLast® Marrone | 903003510 |         |
|  | Roll-up thermal cover • Aufrollbare Wärmeabdeckung                | Grigio antracite | 903003520 | € 5.621 |
|  | Staffe per appoggio copertura avvolgibile                         |                  | 890011330 | € 536   |

**NOTE:** Cover lifter not available • **HINWEIS:** Heber für Thermoabdeckung nicht verfügbar

## ACCESSOIRES • ZUBEHÖRE

|  |  |                 |                   |
|--|--|-----------------|-------------------|
|  | Power Tone Kit (bag with aquagym tools) • (Tasche mit Geräten für Wassergymnastik)   | 890011640       | € 599             |
|  | Non-slip 5-step entry system with handrail and railing,<br>5-stufige, rutschfeste Trittleiter mit Handleiste und Brüstung. | Black • Schwarz | 890011560 € 2.071 |





# J-19 PowerActive™

Design Jacuzzi®



564 x 236 x 134 H cm

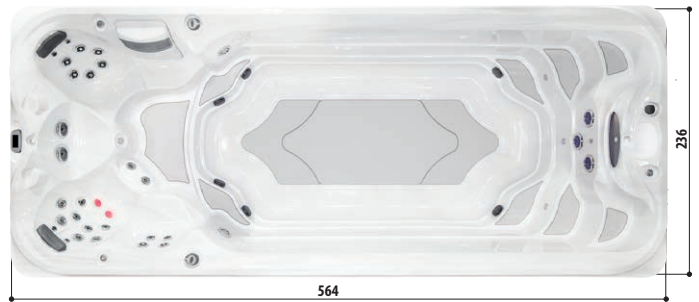

## FEATURES • VERSIONEN

|  |   |          |
|--|---|----------|
|  | PowerPro® Swim AX Jets • Düsen PowerPro® Swim AX  | 2        |
|  | Buoyancy Jet • Schwebedüse  | 1        |
|  | Jets • Düsen  | 26       |
|  | IR and Red Lights • Infrarotlampen und rotes Licht  | 2        |
|  | Swim Selector Control • Kommando Swim Selector  | 2        |
|  | Hydromassage seats • Sitzflächen des Whirlpools   | 4        |
|  | SmartTub®   | ✓        |
|  | Smart Swim Goggles • Schwimmbrille FORM   | optional |
|  | WaterColour™ Waterfall • WaterColour™ Wasserfall  | ✓        |
|  | With Stainless Steel Exercise Bar 120 cm (factory fitted, left side only)<br>Trainingsstange aus Edelstahl 120 cm (nur linke Seite - vormontiert) | ✓        |
|  | Elastic cable with belt for static swimming<br>Elastisches Band mit Gurt für stationäres Schwimmen  | ✓        |
|  | Light System LED Multicolour<br>Mehrfarbige Unterwasser-LED-Leuchte   | ✓        |
|  | CLEARRAY Active Oxygen™   Low output ozone generator + UV-C<br>Ozongenerator mit geringer Emission + UV-C   | ✓        |
|  | Pillow headrest • Kopfstütze  | 2        |
|  | Perma insulated floor • Boden mit Wärmeisolierung   | ✓        |
|  | Double electric heater • Doppeltes elektrisches Heizgerät   | ✓        |
|  | By-pass for auxiliary heating • Bypass für Zusatzheizung  | ✓        |

|                    |   | BUILT-IN               | FREESTANDING |                 |              |
|--------------------|---|------------------------|--------------|-----------------|--------------|
| SKIRTING • PANELEE |   | FINISHING AUSFÜHRUNGEN | BRUSHED GREY | MODERN HARDWOOD | SMOKED EBONY |
|                    | With Stainless Steel Exercise Bar 120 cm (factory fitted, left side only)<br>Trainingsstange aus Edelstahl 120 cm (nur linke Seite - vormontiert) | Porcelain              | SF76300ENHXM | SF76300ENHXM    | SF76300ENHXM |
|                    |   | Platinum               | SF12300ENHXM | SF12300ENHXM    | SF12300ENHXM |
|                    |   | Silver Pearl           | SF33300ENHXM | SF33300ENHXM    | SF33300ENHXM |
|                    |   |                        | € 40.588     | € 43.824        |              |

## INSULATING COVER to be included in the order • WÄRMEABDECKUNG Muss im Auftrag enthalten sein

|  |   |                               |           |         |
|--|---|-------------------------------|-----------|---------|
|  | Rigid thermal cover in 5 parts<br>Starre 5-teilige Wärmeabdeckung | ProLast® Grey • Grau          | 903003440 | € 2.447 |
|  |   | ProLast® Brown • Braun        | 903003510 |         |
|  | Roll-up thermal cover • Aufrollbare Wärmeabdeckung                | Charcoal grey • Anthrazitgrau | 903003520 | € 5.621 |
|  | Bracket for Rollaway® cover • Bügel für Auflage der Rollabdeckung |                               | 890011330 | € 536   |

**NOTE:** Cover lifter not available • **HINWEIS:** Heber für Thermoabdeckung nicht verfügbar

## ACCESSOIRES • ZUBEHÖRE

|  |   |           |         |
|--|---|-----------|---------|
|  | Smart Swim Goggles • Schwimmbrille FORM   | 890011580 | € 799   |
|  | Power Tone Kit (bag with aquagym tools) • (Tasche mit Geräten für Wassergymnastik)  | 890011640 | € 599   |
|  | Non-slip 5-step entry system with handrail and railing, Black. 5-stufige, rutschfeste Trittleiter mit Handleiste und Brüstung, Schwarz. | 890011560 | € 2.071 |



# J-16 PowerPro™

Design Jacuzzi®



472 x 236 x 134 H cm

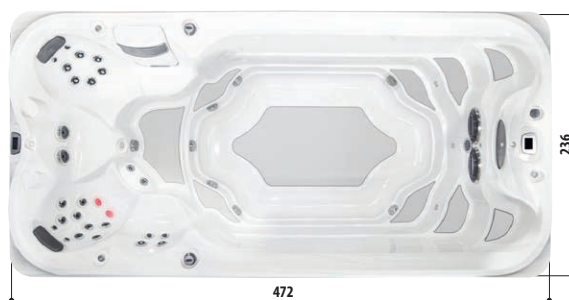

## FEATURES • VERSIONEN

|  |   |    |
|--|---|----|
|  | PowerPro® Swim PX Jets • Düsen PowerPro® Swim PX  | 2  |
|  | Buoyancy Jet • Schwebedüse  | 1  |
|  | Jets • Düsen  | 26 |
|  | IR and Red Lights • Infrarotlampen und rotes Licht  | 2  |
|  | Swim Selector Control • Kommando Swim Selector  | 2  |
|  | Hydromassage seats • Sitzflächen des Whirlpools   | 4  |
|  | SmartTub®   | ✓  |
|  | Smart Swim Goggles • Schwimmbrille FORM   | ✓  |
|  | WaterColour™ Waterfall • WaterColour™ Wasserfall  | ✓  |
|  | With Stainless Steel Exercise Bar 120 cm (factory fitted, left side only)<br>Trainingsstange aus Edelstahl 120 cm (nur linke Seite - vormontiert) | ✓  |
|  | Elastic cable with belt for static swimming<br>Elastisches Band mit Gurt für stationäres Schwimmen  | ✓  |
|  | Light System LED Multicolour<br>Mehrfarbige Unterwasser-LED-Leuchte   | ✓  |
|  | CLEARRAY Active Oxygen™ Low output ozone generator + UV-C<br>Ozongenerator mit geringer Emission + UV-C   | ✓  |
|  | Pillow headrest • Kopfstütze  | 2  |
|  | Perma insulated floor • Boden mit Wärmeisolierung   | ✓  |
|  | Double electric heater • Doppeltes elektrisches Heizgerät   | ✓  |
|  | By-pass for auxiliary heating • Bypass für Zusatzheizung  | ✓  |

|                    |   | BUILT-IN               | FREESTANDING |                 |              |              |
|--------------------|---|------------------------|--------------|-----------------|--------------|--------------|
| SKIRTING • PANELEE |   | FINISHING AUSFÜHRUNGEN | BRUSHED GREY | MODERN HARDWOOD | SMOKED EBONY |              |
|                    | With Stainless Steel Exercise Bar 120 cm (factory fitted, left side only)<br>Trainingsstange aus Edelstahl 120 cm (nur linke Seite - vormontiert) | Porcelain              | SJ76300ENHXM | SJ763U0ENHXM    | SJ763D0ENHXM | SJ763Y0ENHXM |
|                    |   | Platinum               | SJ12300ENHXM | SJ123U0ENHXM    | SJ123D0ENHXM | SJ123Y0ENHXM |
|                    |   | Silver Pearl           | SJ33300ENHXM | SJ333U0ENHXM    | SJ333D0ENHXM | SJ333Y0ENHXM |
|                    |   |                        | € 42.242     | € 45.189        |              |              |

## INSULATING COVER to be included in the order • WÄRMEABDECKUNG Muss im Auftrag enthalten sein

|  |   |                               |           |         |
|--|---|-------------------------------|-----------|---------|
|  | Rigid thermal cover in 5 parts<br>Starre 5-teilige Wärmeabdeckung | ProLast® Grey • Grau          | 903003450 | € 2.339 |
|  |   | ProLast® Brown • Braun        | 903003530 |         |
|  | Roll-up thermal cover • Aufrollbare Wärmeabdeckung                | Charcoal grey • Anthrazitgrau | 903003540 | € 4.882 |
|  | Bracket for Rollaway® cover • Bügel für Auflage der Rollabdeckung |                               | 890011330 | € 536   |

**NOTE:** Cover lifter not available • **HINWEIS:** Heber für Thermoabdeckung nicht verfügbar

## ACCESSOIRES • ZUBEHÖRE

|  |  |                 |           |         |
|--|--|-----------------|-----------|---------|
|  | Power Tone Kit (bag with aquagym tools) • (Tasche mit Geräten für Wassergymnastik)   |                 | 890011640 | € 599   |
|  | Non-slip 5-step entry system with handrail and railing,<br>5-stufige, rutschfeste Trittleiter mit Handleiste und Brüstung. | Black • Schwarz | 890011560 | € 2.071 |





# J-16 PowerActive™

Design Jacuzzi®



472 x 236 x 134 H cm

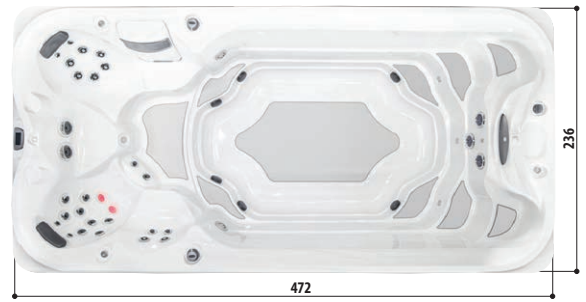

## FEATURES • VERSIONEN

|  |   |          |
|--|---|----------|
|  | PowerPro® Swim AX Jets • Düsen PowerPro® Swim AX  | 2        |
|  | Buoyancy Jet • Schwebedüse  | 1        |
|  | Jets • Düsen  | 26       |
|  | IR and Red Lights • Infrarotlampen und rotes Licht  | 2        |
|  | Swim Selector Control • Kommando Swim Selector  | 2        |
|  | Hydromassage seats • Sitzflächen des Whirlpools   | 4        |
|  | SmartTub®   | ✓        |
|  | Smart Swim Goggles • Schwimmbrille FORM   | optional |
|  | WaterColour™ Waterfall • WaterColour™ Wasserfall  | ✓        |
|  | With Stainless Steel Exercise Bar 120 cm (factory fitted, left side only)<br>Trainingsstange aus Edelstahl 120 cm (nur linke Seite - vormontiert) | ✓        |
|  | Elastic cable with belt for static swimming<br>Elastisches Band mit Gurt für stationäres Schwimmen  | ✓        |
|  | Light System LED Multicolour<br>Mehrfarbige Unterwasser-LED-Leuchte   | ✓        |
|  | CLEARRAY Active Oxygen™   Low output ozone generator + UV-C<br>Ozongenerator mit geringer Emission + UV-C   | ✓        |
|  | Pillow headrest • Kopfstütze  | 2        |
|  | Perma insulated floor • Boden mit Wärmeisolierung   | ✓        |
|  | Double electric heater • Doppeltes elektrisches Heizgerät   | ✓        |
|  | By-pass for auxiliary heating • Bypass für Zusatzheizung  | ✓        |

|                    |   | BUILT-IN               | FREESTANDING |                 |              |              |
|--------------------|---|------------------------|--------------|-----------------|--------------|--------------|
| SKIRTING • PANELEE |   | FINISHING AUSFÜHRUNGEN | BRUSHED GREY | MODERN HARDWOOD | SMOKED EBONY |              |
|                    | With Stainless Steel Exercise Bar 120 cm (factory fitted, left side only)<br>Trainingsstange aus Edelstahl 120 cm (nur linke Seite - vormontiert) | Porcelain              | SM76300ENHXM | SM763U0ENHXM    | SM763D0ENHXM | SM763Y0ENHXM |
|                    |   | Platinum               | SM12300ENHXM | SM123U0ENHXM    | SM123D0ENHXM | SM123Y0ENHXM |
|                    |   | Silver Pearl           | SM33300ENHXM | SM333U0ENHXM    | SM333D0ENHXM | SM333Y0ENHXM |
|                    |   |                        | € 36.666     | € 39.571        |              |              |

## INSULATING COVER to be included in the order • WÄRMEABDECKUNG Muss im Auftrag enthalten sein

|  |   |                               |           |         |
|--|---|-------------------------------|-----------|---------|
|  | Rigid thermal cover in 5 parts<br>Starre 5-teilige Wärmeabdeckung | ProLast® Grey • Grau          | 903003450 | € 2.339 |
|  |   | ProLast® Brown • Braun        | 903003530 |         |
|  | Roll-up thermal cover • Aufrollbare Wärmeabdeckung                | Charcoal grey • Anthrazitgrau | 903003540 | € 4.882 |
|  | Bracket for Rollaway® cover • Bügel für Auflage der Rollabdeckung |                               | 890011330 | € 536   |

**NOTE:** Cover lifter not available • **HINWEIS:** Heber für Thermoabdeckung nicht verfügbar

## ACCESSOIRES • ZUBEHÖRE

|  |   |           |         |
|--|---|-----------|---------|
|  | Smart Swim Goggles • Schwimmbrille FORM   | 890011580 | € 799   |
|  | Power Tone Kit (bag with aquagym tools) • (Tasche mit Geräten für Wassergymnastik)  | 890011640 | € 599   |
|  | Non-slip 5-step entry system with handrail and railing, Black. 5-stufige, rutschfeste Trittleiter mit Handleiste und Brüstung, Schwarz. | 890011560 | € 2.071 |



# J-13 PowerPlay™

Design Jacuzzi®



381 x 236 x 127 H cm

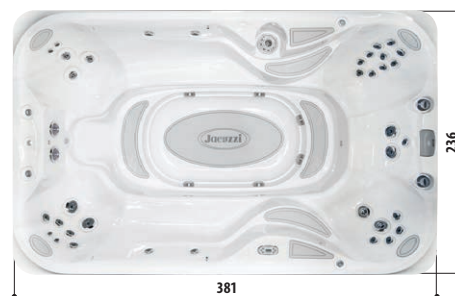

## FEATURES • VERSIONEN

|  |  | FREESTANDING |
|--|--|--------------|
|  | PowerPro® Swim CX Jets • Düsen PowerPro® Swim CX   | <b>2</b>     |
|  | Buoyancy Jet • Schwebedüse   | <b>1</b>     |
|  | Jets • Düsen   | <b>36</b>    |
|  | Swim Selector Control • Kommando Swim Selector   | <b>1</b>     |
|  | Hydromassage seats • Sitzflächen des Whirlpools  | <b>8</b>     |
|  | SmartTub®  | ✓            |
|  | Smart Swim Goggles • Schwimmbrille FORM  | optional     |
|  | WaterColour™ Waterfall • WaterColour™ Wasserfall   | ✓            |
|  | With Stainless Steel Exercise Bar 60 cm (factory fitted, above Swim jets)<br>Trainingsstange aus Edelstahl 60 cm (über den Düsen Swim - vormontiert) | ✓            |
|  | Elastic cable with belt for static swimming<br>Elastisches Band mit Gurt für stationäres Schwimmen   | ✓            |
|  | Light System LED Multicolour<br>Mehrfarbige Unterwasser-LED-Leuchte  | ✓            |
|  | CLEAR RAY Active Oxygen™   Low output ozone generator + UV-C<br>Ozongenerator mit geringer Emission + UV-C   | ✓            |
|  | Pillow headrest • Kopfstütze   | <b>4</b>     |
|  | Perma insulated floor • Boden mit Wärmeisolierung  | ✓            |
|  | Double electric heater • Doppelpes elektrisches Heizgerät  | - -          |
|  | By-pass for auxiliary heating • Bypass für Zusatzheizung   | ✓            |

## SKIRTING • PANELEE

|  | FINISHING<br>AUSFÜHRUNGEN | BRUSHED<br>GREY | MODERN<br>HARDWOOD   | SMOKED<br>EBONY |
|--|---------------------------|-----------------|--|-----------------|
|  |                           |                 | With Stainless Steel Exercise Bar 60 cm (factory fitted, above Swim jets)<br>Trainingsstange aus Edelstahl 60 cm (über den Düsen Swim - vormontiert) | SO763U0ENMW     |
|  | Porcelain                 | SO123U0ENMW     | SO123D0ENMW  | SO123Y0ENMW     |
|  | Platinum                  | SO333U0ENMW     | SO333D0ENMW  | SO333Y0ENMW     |
|  | Silver Pearl              | SO333U0ENMW     | SO333D0ENMW  | SO333Y0ENMW     |
|  |                           | <b>€ 29.405</b> |  |                 |

## INSULATING COVER to be included in the order • WÄRMEABDECKUNG Muss im Auftrag enthalten sein

|  |   |                               |           |                |
|--|---|-------------------------------|-----------|----------------|
|  | Rigid thermal cover in 4 parts<br>Starre 4-teilige Wärmeabdeckung | ProLast® Grey • Grau          | 903003550 | <b>€ 2.229</b> |
|  |   | ProLast® Brown • Braun        | 903003560 |                |
|  | Roll-up thermal cover • Aufrollbare Wärmeabdeckung                | Charcoal grey • Anthrazitgrau | 903003570 | <b>€ 4.458</b> |
|  | Bracket for Rollaway® cover • Bügel für Auflage der Rollabdeckung |                               | 890011330 | <b>€ 536</b>   |

**NOTE:** Cover lifter not available • **HINWEIS:** Heber für Thermoabdeckung nicht verfügbar

## ACCESSOIRES • ZUBEHÖRE









|  |  |                 |              |                |
|--|--|-----------------|--------------|----------------|
|  | Smart Swim Goggles • Schwimmbrille FORM  | 890011580       | <b>€ 799</b> |                |
|  | Power Tone Kit (bag with aquagym tools) • (Tasche mit Geräten für Wassergymnastik)   | 890011640       | <b>€ 599</b> |                |
|  | Non-slip 5-step entry system with handrail and railing.<br>5-stufige, rutschfeste Trittleiter mit Handleiste und Brüstung. | Black • Schwarz | 890011560    | <b>€ 2.071</b> |



# SWIM SPA

## ACCESSORIES AND INSULATING COVER

### ZUBEHÖR UND WÄRMEABDECKUNG

| ACCESSOIRES<br>ZUBEHÖRE   | Description<br>Beschreibung  |   | Code<br>Kode                    |              |
|---|--|---|---------------------------------|--------------|
|    | Smart Swim Goggles<br>Schwimmbrille FORM   | Included in models<br>Gehört zum<br>Lieferumfang der Modelle<br>PowerPro™<br><br>Optional for<br>PowerActive™ - PowerPlay™                      | 890011580<br><br>€ 799          |              |
|    | Power Tone Kit - bag with aquagym tools<br>Swing Trainer + Hydro bells + Resistance training fins<br>Power Tone Kit - Tasche mit Geräten für Wassergymnastik<br>Swing Trainer + Hydro bells + Resistance training fins | Optional  | 890011640<br><br>€ 599          |              |
|    | Elastic cable with belt for static swimming<br>Elastisches Band mit Gurt für stationäres Schwimmen   | Included in models<br>Gehört zum<br>Lieferumfang der Modelle<br>PowerPro™<br>PowerActive™<br>PowerPlay™   | 890011630<br><br>€ 69           |              |
|   | Non-slip 5-step entry system with handrail and railing. Black<br>5-stufige, rutschfeste Trittleiter mit Handleiste und Brüstung.<br>Schwarz  | L 76,2 x P 152,4 x H 88,9 cm<br>Single Step / Eine Stufe<br>L 76,2 x P 25,4 x H 17,8 cm<br>Top platform / Obere Plattform<br>L 76,2 x P 50,8 cm | 890011560<br><br>€ 2.071        |              |
| INSULATING COVER<br>WÄRMEABDECKUNG  | Model<br>Modell  | Material<br>Material  | Finishing<br>Oberflächenzubehör | Code<br>Kode |
|  | SWIM SPA J-19™   | Prolast™  | Grey • Grau                     | 903003440    |
|   |  |   | Brown • Braun                   | 903003510    |
|   |  |   |                                 | € 2.447      |
|  | SWIM SPA J-16™   | Prolast™  | Grey • Grau                     | 903003450    |
|   |  |   | Brown • Braun                   | 903003530    |
|   |  |   |                                 | € 2.339      |
|  | SWIM SPA J-13™   | Prolast™  | Grey • Grau                     | 903003550    |
|   |  |   | Brown • Braun                   | 903003560    |
|   |  |   |                                 | € 2.229      |
|  | SWIM SPA J-19™<br>L. 564 x P. 238 cm   | Rollaway®   | Charcoal grey<br>Anthrazitgrau  | 903003520    |
|   | SWIM SPA J-16™<br>L. 478 x P. 238 cm   |   |                                 | 903003540    |
|   | SWIM SPA J-13™<br>L. 386 x P. 238 cm   |   |                                 | 903003570    |
|   |  |   |                                 | € 4.458      |

Rollaway® is 12 kg / meter. Once rolled up, the diameter is about 70 cm.

Rollaway® wiegt 12 kg pro Meter.  
Im aufgerollten Zustand beträgt der Durchmesser ungefähr 70 cm.

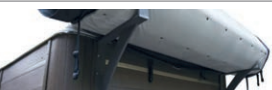
|   |  |                        |
|---|--|------------------------|
|  | Bracket for Rollaway® cover<br>Bügel für Auflage der Rollabdeckung | 890011330<br><br>€ 536 |
|---|--|------------------------|

NOTE: Accessories marked with dedicated codes to be ordered separately are not included or installed on the product.

NOTE: Optional und accessoires, die mit entsprechenden Codes gekennzeichnet sind, die separat bestellt werden müssen, sind nicht im Produkt inbegriffen oder installiert.

# OUTDOOR SHOWER COLUMN DUSCHSÄULE FÜR AUSSENBEREICHE





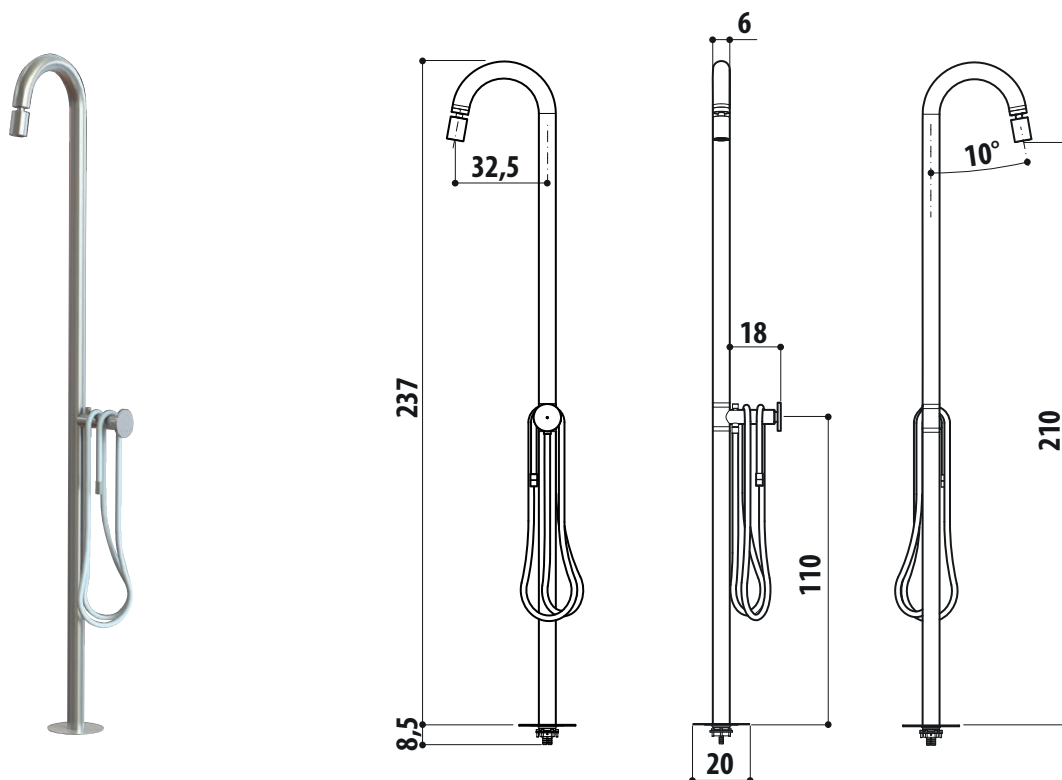





MADE IN ITALY

Design Nespoli\_Novara - Design Jacuzzi®



| Description<br>Beschreibung   | Dimensions<br>Abmessungen | Code<br>Kode                    |
|---|---------------------------|---------------------------------|
| <p>Outdoor shower column, matte stainless steel 316L with progressive single-lever mixer (cold-hot water) and grey silicone rubber hose.</p> <p>Duschsäule für Außenbereiche aus satiniertem Edelstahl 316L mit Einhandmischer mit progressiver Kartusche (Kalt-Heißwasser), flexibel aus Silikongummi, Grau.</p> | <p>Ø 6 x 237 H cm</p>     | <p>228501130</p> <p>€ 3.442</p> |
| <p>Recessed body for outdoor shower column (to be paired with code 228501130)</p> <p>Einbaugehäuse für Duschsäule für Außenbereiche (für die Kombination mit dem Code 228501130)</p>  | <p>Ø 20 x 8,5 H cm</p>    | <p>228501150</p> <p>€ 235</p>   |



|   | Description<br>Beschreibung   | Dimensions<br>Abmessungen | Finishing<br>Oberflächenzubehör | Code<br>Kode         |
|---|---|---------------------------|---------------------------------|----------------------|
| <b>STEPS • STUFE</b>  |   |                           |                                 |                      |
|    | VersaStep™ - 2 steps<br>VersaStep™ - zweistufig   | 75 x 50 x 35 H cm         | BRUSHED GREY                    | 890011360<br>€ 602   |
|    | VersaStep™ - 2 steps<br>VersaStep™ - zweistufig   | 75 x 50 x 35 H cm         | MODERN HARDWOOD                 | 890011350<br>€ 602   |
|   | VersaStep™ - 2 steps<br>VersaStep™ - zweistufig   | 75 x 50 x 35 H cm         | SMOKED EBONY                    | 890011370<br>€ 602   |
|  | Smart Step - 2 steps<br>Smart Step - zweistufig   | 90 x 60 x 40 H cm         | BLACK • SCHWARZ                 | 890011600<br>€ 526   |
| <b>COVER LIFTER • LIFT FÜR WÄRMEABDECKUNG</b>                                       |   |                           |                                 |                      |
|  | Cover lifter hydraulic assist - fastening on panel<br>Hydraulischer Heber für Wärmeabdeckung - Verankerung im Paneel  |                           |                                 | 890011520<br>€ 865   |
|   | Specific for the models of the collection • Speziell für den Modellen der Kollektion J-LX® - J-300™   |                           |                                 |                      |
|  | Cover lifter manual drop-behind - fastening on panel<br>Manueller Lift für Wärmeabdeckung (hinter dem Whirlpool) - Verankerung im Paneel  |                           | <b>new</b>                      | 890011440<br>€ 1.310 |
|   | Compatible with the models of the collection • Kompatibel mit den Modellen der Kollektion J-LX® - J-300™  |                           |                                 |                      |
|  | Cover lifter manual - fastening on panel<br>Manueller Lift für Wärmeabdeckung - Verankerung im Paneel   |                           |                                 | 890011450<br>€ 541   |
|   | Compatible with the models of the collection • Kompatibel mit den Modellen der Kollektion J-LX® - J-300™  |                           |                                 |                      |
|  | Cover lifter hydraulic assist - fastening on panel<br>Hydraulischer Heber für Wärmeabdeckung - Verankerung im Paneel  |                           |                                 | 890011460<br>€ 757   |
|   | Compatible with the models of the collection • Kompatibel mit den Modellen der Kollektion J-LX® - J-300™  |                           |                                 |                      |
|  | Cover lifter undermount manual - fastening on base<br>Manueller Lift für Wärmeabdeckung - Verankerung in der Basis  |                           |                                 | 890011500<br>€ 865   |
|   | Compatible with the models of the collections • Kompatibel mit den Modellen der Kollektionen J-300™ - J-200™ Classic - LODGE+   |                           |                                 |                      |
| <b>OPTIONAL</b>   |   |                           |                                 |                      |
|  | SmartTub® Wireless Sensor Kit<br>Includes Spa Cover Sensor + Drain and Fill Sensors + Water Sensor<br>Kit Wireless-Sensoren SmartTub®<br>Umfasst Sensor der Wärmeabdeckung + Sensoren für Ablauf und Befüllung - Wassersensor |                           | <b>new</b>                      | 919405450<br>€ 560   |
|   | Compatible with the models of the collection with SmartTub® • Kompatibel mit den Modellen der Kollektion mit SmartTub® J-LX® - J-400™ - J-300™  |                           |                                 |                      |



## INSULATING COVER WÄRMEABDECKUNG

| Model<br>Modell                  | Material | Finishing<br>Oberflächenzubehör | Code<br>Kode | Price<br>Preis |
|----------------------------------|----------|---------------------------------|--------------|----------------|
| <b>J-400™ COLLECTION</b>         |          |                                 |              |                |
| J-495™                           | PROLAST™ | Black • Schwarz                 | 903003260    | € 2.004        |
| J-485™ / J-475™                  | PROLAST™ | Black • Schwarz                 | 903003330    | € 1.475        |
| J-445™ / J-435™                  | PROLAST™ | Black • Schwarz                 | 903003420    | € 1.386        |
| <b>J-LX® COLLECTION</b>          |          |                                 |              |                |
| J-LX® / J-LXL®                   | PROLAST™ | Black • Schwarz                 | 903003950    | € 1.500        |
| <b>J-300™ COLLECTION</b>         |          |                                 |              |                |
| J-385™ / J-375™                  | PROLAST™ | Black • Schwarz                 | 903002941    | € 1.491        |
| J-365™ / J-355™                  | PROLAST™ | Black • Schwarz                 | 903003221    | € 1.398        |
| J-345™ / J-335™                  | PROLAST™ | Black • Schwarz                 | 903002411    | € 1.395        |
| J-325™                           | PROLAST™ | Black • Schwarz                 | 903003590    | € 1.328        |
| J-315™                           | PROLAST™ | Black • Schwarz                 | 903003610    | € 1.203        |
| <b>J-200™ CLASSIC COLLECTION</b> |          |                                 |              |                |
| J-245™ / J-235™                  | PROLAST™ | Black • Schwarz                 | 903003211    | € 1.110        |



| Model<br>Modell | Material<br>Material | Finshing<br>Oberflächenzubehör | Code<br>Kode | Price<br>Preis |
|-----------------|----------------------|--------------------------------|--------------|----------------|
|-----------------|----------------------|--------------------------------|--------------|----------------|

### DESIGN COLLECTION

|           |          |     |           |         |
|-----------|----------|-----|-----------|---------|
| VIRTUS    | ProVinyl | Ice | 903002472 | € 2.090 |
| PROFILE   | ProVinyl | Ice | 903002202 | € 1.257 |
| SANTORINI | ProVinyl | Ice | 903001482 | € 1.367 |
| DELOS     | ProVinyl | Ice | 903001542 | € 1.129 |
| DELFI     | ProVinyl | Ice | 903001562 | € 1.063 |
| UNIQUE    | ProVinyl | Ice | 903001682 | € 919   |
| CITY™ SPA | ProVinyl | Ice | 903001732 | € 851   |
| ALIMIA    | ProVinyl | Ice | 903001672 | € 1.137 |

### LODGE+ COLLECTION

|          |          |             |           |         |
|----------|----------|-------------|-----------|---------|
| LODGE+ L | ProVinyl | Grey • Grau | 903001972 | € 1.286 |
| LODGE+ M | ProVinyl | Grey • Grau | 903001902 | € 1.141 |
| LODGE+ S | ProVinyl | Grey • Grau | 903001982 | € 911   |

### PROFESSIONAL COLLECTION

|              |          |     |           |         |
|--------------|----------|-----|-----------|---------|
| VIRTUS PRO   | ProVinyl | Ice | 903002472 | € 2.090 |
| ENJOY PRO    | ProVinyl | Ice | 903001872 | € 1.594 |
| VIRGINIA PRO | ProVinyl | Ice | 903001652 | € 1.357 |
| SIENNA PRO   | ProVinyl | Ice | 903001662 | € 1.274 |
| ALIMIA PRO   | ProVinyl | Ice | 903001712 | € 1.274 |

# COLORS, MATERIALS AND FINISHES

## FARBEN, MATERIALIEN UND AUSFÜHRUNGEN

| COLLECTIONS<br>KOLLEKTION | SHELL COLOR · FARBEN (SCHALE) |                         |                         |                         |        |
|---------------------------|-------------------------------|-------------------------|-------------------------|-------------------------|--------|
|                           | ACRYLIC / ACRYL               |                         |                         |                         |        |
|                           | Platinum                      | Porcelain               | Silver Pearl            | Midnight                | Cobalt |
| J-400™                    | X                             | X                       | X                       | X                       |        |
| J-LX®                     | X                             | X                       |                         |                         |        |
| J-300™                    | X                             | X                       | X                       | X                       |        |
| J-200™ Classic            | X                             | On demand · Auf Anfrage | On demand · Auf Anfrage | On demand · Auf Anfrage |        |
| DESIGN                    | X*                            | X                       |                         |                         | X*     |
| LODGE+                    | X                             | X                       |                         |                         |        |
| PROFESSIONAL              | X                             | X                       |                         |                         | X*     |
| SWIM SPA                  | X                             | X                       | X                       |                         |        |

| COLLECTIONS<br>KOLLEKTION | CABINET COLOR · PANEELAUSFÜHRUNGEN |                    |                 |                              |                     |          |              |                                       |                     |
|---------------------------|------------------------------------|--------------------|-----------------|------------------------------|---------------------|----------|--------------|---------------------------------------|---------------------|
|                           | PROFINISH™                         |                    |                 | SYNTHETIC WOOD<br>HOLZIMITAT |                     |          | WOOD<br>HOLZ | COMPOSITE-PVC<br>VERBUNDWERKSTOFF-PVC |                     |
|                           | Brushed<br>Grey                    | Modern<br>Hardwood | Smoked<br>Ebony | Silverwood                   | Roasted<br>Chestnut | Graphite | Teak         | White Oak                             | Grey Oak            |
| J-400™                    | X                                  | X                  | X               |                              |                     |          |              |                                       |                     |
| J-LX®                     | X                                  | X                  | X               |                              |                     |          |              |                                       |                     |
| J-300™                    | X                                  | X                  | X               |                              |                     |          |              |                                       |                     |
| J-200™ Classic            |                                    |                    |                 | X                            |                     |          |              |                                       |                     |
| DESIGN                    |                                    |                    |                 |                              |                     | X*       | X*           | City™ Spa<br>Unique                   | City™ Spa<br>Unique |
| LODGE+                    |                                    |                    |                 | X                            | X                   |          |              |                                       |                     |
| PROFESSIONAL              |                                    |                    |                 |                              |                     |          |              |                                       |                     |
| SWIM SPA                  | X                                  | X                  | X               |                              |                     |          |              |                                       |                     |

| COLLECTIONS<br>KOLLEKTION | COVER COLOR · WÄRMEABDECKUNG |                |              |          |              |                                |
|---------------------------|------------------------------|----------------|--------------|----------|--------------|--------------------------------|
|                           | PROLAST™                     |                |              | PROVINYL |              | ROLLAWAY®                      |
|                           | Black<br>Schwarz             | Brown<br>Braun | Grey<br>Grau | Ice      | Grey<br>Grau | Charcoal grey<br>Anthrazitgrau |
| J-400™                    | X                            |                |              |          |              |                                |
| J-LX®                     | X                            |                |              |          |              |                                |
| J-300™                    | X                            |                |              |          |              |                                |
| J-200™ Classic            | X                            |                |              |          |              |                                |
| DESIGN                    |                              |                |              | X        |              |                                |
| LODGE+                    |                              |                |              |          | X            |                                |
| PROFESSIONAL              |                              |                |              | X        |              |                                |
| SWIM SPA                  |                              | X              | X            |          |              | X                              |

\* Check on price list by model • \* In der Preisliste für das Modell prüfen

PLATINUM

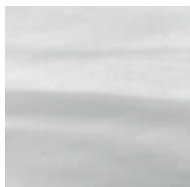

PORCELAIN

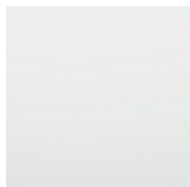

SILVER PEARL



MIDNIGHT

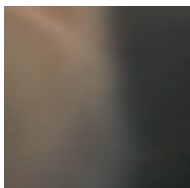

COBALT

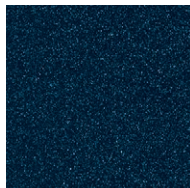

**ProFinish™**

BRUSHED GREY



MODERN HARDWOOD



SMOKED EBONY



**Synthetic wood · Holzimitat**

SILVERWOOD



ROASTED CHESTNUT

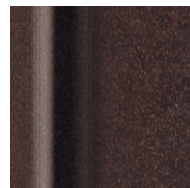

GRAPHITE



**Wood · Holz**

TEAK



TEAK - Profile

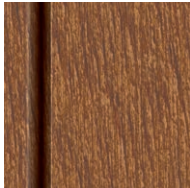

**Composite-PVC · Verbundwerkstoff-PVC**

WHITE OAK

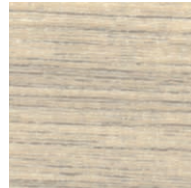

GREY OAK

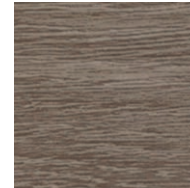

**Prolast™**

BLACK · SCHWARZ



BROWN · BRAUN

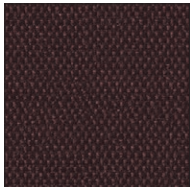

GREY · GRAU



**Provinyl**

ICE

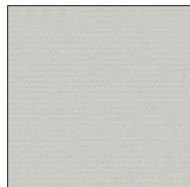

GREY · GRAU

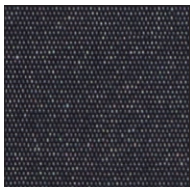

**Rollaway®**

CHARCOAL GREY · ANTHRACITGRAU





#### Art. 1 General provisions

1.1. The current general terms, except for any exceptions specifically agreed in writing, enforce all current and future sales contracts between parties.

#### Art. 2 Formation and purpose of the contract

2.1. Jacuzzi Europe S.p.A. is committed to each order only after its acceptance in writing. Acceptance of the order by Jacuzzi Europe S.p.A. can also lead to its execution.

#### Art. 3 Delivery

3.1. Except for other written agreement, delivery is "Ex-works" Valvasone (Pn) – Italy. If the purchaser (retailer) does not provide for collection of goods, Jacuzzi Europe S.p.A. will have the right to entrust a reliable carrier with transport. In the event of non-collection the purchaser (retailer) will be bound to pay stock expenses.

3.2. The delivery terms agreed are indicative. In the event of delays, the purchaser (retailer), therefore, will not be able to forward any claim for compensation for damages.

#### Art. 4 Packaging

4.1. The packaging of appliances conforms to international transport norms carried out by land using motor vehicles. Non-standard packaging will entail an extra charge and will be agreed at the time of order.

#### Art. 5 Cancellation of orders

5.1. The purchaser's (retailer's) order constitutes a firm purchasing proposal. No order can be cancelled without the written consent of Jacuzzi Europe S.p.A. In the event of cancellation of orders, Jacuzzi Europe S.p.A. also reserves the right to demand compensation for damages.

#### Art. 6 Design – Technical data

6.1. Jacuzzi Europe S.p.A. reserves the right to stop, without warning, the manufacture of any model and to alter models during production, with no obligation to carry out the same modifications to previously sold products.

6.2. The data and features in the Jacuzzi Europe S.p.A. technical and publicity documentation (catalogues, handbooks, publicity brochures, illustrations, price lists) are subject to modifications and are not binding.

#### Art. 7 Prices

7.1. Prices, excluding VAT, are those stated on the price lists in force at the time of ordering and refer to goods with delivery "Ex-works" Valvasone (Pn) – Italy, unless otherwise agreed.

7.2. Prices, quotations and discounts are subject to variation without the obligation of forewarning on the part of Jacuzzi Europe S.p.A.

7.3. All orders received after modification of price lists, as well as planned consignments after thirty days from notification of the variation, are subject to the new prices.

#### Art. 8 Payment

8.1. Payment of goods is considered validly made only when Jacuzzi Europe S.p.A. has been credited with the relative amounts.

8.2. Any delay or irregularity in payment gives Jacuzzi Europe S.p.A. the right to suspend supplies or to annul current contracts, even if they do not pertain to the payments in question, and also the right to compensation for any damage (including that related to currency devaluation). Jacuzzi Europe S.p.A. has the right in each case – starting from the expiry date of payment, without the need of a default action – to legal interest, which will be increased by 5 (five) points.

8.3. The purchaser (retailer) is bound to full payment also in the event of dispute or controversy. Compensation with possible credit claims from Jacuzzi Europe S.p.A. is not permitted without written authorization.

8.4. In the event of non-payment, even if only partial, Jacuzzi Europe S.p.A. has the right – at its discretion – to demand from the purchaser (retailer) payment of the full sum stated in the contract or to declare the contract null and void, with the right to obtain the return of the delivered goods and to withhold, as compensation for damages, the amounts collected up to that moment, except for any other action for greater damage.

#### Art. 9 Property reservation

9.1. In the event that full or part payment must be made after delivery, the delivered products remain the property of Jacuzzi Europe S.p.A. until the moment of full payment of the price, according to the provisions of art. 1523 of the Civil Code.

9.2. As provided by the aforesaid property reservation, Jacuzzi Europe S.p.A. will have the right to proceed with the collection of any unpaid goods; in which case all related costs will be at the expense of the purchaser (retailer) and Jacuzzi Europe S.p.A. will be able to withhold any amounts already collected as compensation for damage. If the purchaser (retailer) has resold the goods to third parties, the rights laid claim to by Jacuzzi Europe S.p.A., as provided in the present clause, will refer to the price obtained from the sale of the same goods.

#### Art. 10 Circumstances beyond control and excessive onerousness

10.1. Events constituting cases of exemption from responsibility are fires, collapse, floods, non-delivery of supplies, transport difficulties, strikes, closures or other events due to circumstances beyond control, which impede or considerably reduce production by Jacuzzi Europe S.p.A. or its suppliers, or seriously hinder transport of the sold goods. Annulment of the contract and also the provision of other solutions that are different from the claim for compensation for damages, are only permitted for impediments that continue for at least 60 days.

10.2. If the fulfilment of obligations, before their execution, by Jacuzzi Europe S.p.A. is considered excessively onerous, for any unexpected reason by a trader with normal experience in this sector – with regard to the original agreement thus altering the ratio itself by 20% or more – Jacuzzi Europe S.p.A. will be able to request a review of contractual terms or, in the event of non-agreement, declare the contract null and void.

#### Art. 11 Claims

11.1. The purchaser (retailer) is bound to declare any damage to the product, or non-conformity in delivery that could be discovered when in possession of the goods, in specific detail in writing otherwise the claim will be null and void. This must be within and no more than 8 days from the time the goods were made available.

11.2. Any defects in conformity that are not identified following a check of the goods as in paragraph 11.1 must be declared by the purchaser, or will be null and void, not later than the time provided by law. This starts from the moment the goods themselves were made available to the purchaser.

#### Art. 12 Warranty

12.1. In accordance with the contents of its Conventional Warranty Conditions, Jacuzzi Europe S.p.A. guarantees, all "Jacuzzi™" branded products or those marketed by Jacuzzi Europe S.p.A. through the network of Jacuzzi® branded distributors (hereafter the "Products") purchased, installed and used within the countries of the European Union for domestic purposes, unrelated to the business/professional activity carried out by the consumer, against conformity defects.

The Conventional Warranty applies only in the European Union country in which the purchase of the Products by the retailer is made (hereinafter the "Country of Purchase"). Products installed in a country other than the country of purchase are not covered by the Conventional Warranty.

For products purchased or used outside the European Union, the burden of the warranty and the consequent interventions necessary to eliminate any lack of conformity of the equipment will be at the full and exclusive expense of the purchaser (retailer), that shall therefore set up its own technical assistance organisation, unless otherwise agreed in writing with Jacuzzi Europe S.p.A.

Moreover, the Conventional Warranty does not apply if the regulations of the country of purchase require the Products also, to comply with different and/or more restrictive regulatory requirements than those prescribed by EU regulations and can be applied only on condition that Jacuzzi Europe S.p.A. has an authorised technical service centre in the "Country of purchase".

The warranty, which starts from the date of delivery of the product to the end user, is intended to be valid only upon payment of the total price of the equipment, provided that the intervention is carried out by Jacuzzi Europe S.p.A. authorised technicians and is valid for a period of a) twelve (12) months, for products exhibited in commercial premises, trade fairs, showrooms or other commercial/promotional events, with the exception of damage caused directly and/or indirectly to the product by its prolonged exposure or by its transportation/dissassembly/reassembly from one place of exhibition to another; b) twenty-four (24) months, for products other than those indicated in paragraph a). This warranty does not cover products the production of which has been discontinued for longer than twenty-four (24) months or which have become obsolete, meaning products from Jacuzzi Europe S.p.A. purchased more than sixty (60) months after the date of manufacture. Jacuzzi Europe S.p.A. reserves the right to verify whether the product is covered by this warranty.

12.2. The warranty is only valid if the installation and connection of the product to the electricity and water networks were performed by meticulously following the instructions and provisions contained in the Jacuzzi Europe S.p.A. user instruction manual and/or other equivalent documentation which includes product installation, usage and maintenance instructions, (hereinafter, "Jacuzzi Documentation"). If the product is located in sites which are difficult to reach on ordinary roads (e.g. in mountain areas or on minor islands), or if it was installed in a site which is not easily accessible and/or was installed in combination with premium materials, all costs (labour and material costs, including disassembly/reassembly, removal and relocation of the product and its components) shall be borne entirely by the purchaser (retailer), where responsible, or by the consumer; in no case shall Jacuzzi Europe S.p.A. be liable for such additional costs. The warranty expires if the product components or other parts are modified with respect to their original supply conditions.

12.3. The equipment shall not be replaced, either totally or partially (with the same product or with another product having similar characteristics) if this is objectively impossible or excessively expensive compared to the repair, or if it involves unreasonable expenses for Jacuzzi Europe S.p.A. compared to its repair, taking into account the value that the product would have if it were free from manufacturing defect, the extent of the defect, the possibility that the alternative remedy can be implemented without significant inconvenience to the end user. If during the period of validity of this warranty, the authorised technical personnel of Jacuzzi Europe S.p.A. ascertains a manufacturing defect of the product existing at the time of delivery and Jacuzzi Europe S.p.A. authorises return in advance, the latter will refund the buyer (retailer) the price of the product, as indicated in the sales invoice issued to the latter by Jacuzzi Europe S.p.A.

12.4. The warranty applies exclusively to non-conformities deriving from causes not attributable to Jacuzzi Europe S.p.A., such as, for example: incorrect periodic product maintenance and/or lack of diligence in performing the same; improper use of the product or which does not conform to the instructions in the Jacuzzi Documentation or which are in violation of the technical and/or safety measures required in the country of use, the laws, regulations and customs applicable therein; wrong and/or incorrect connection and/or setting of the product parameters; use of non-original spare parts; transport damages not reported within the legal terms or caused by transporters not authorised by Jacuzzi Europe S.p.A.; inefficiencies or anomalies of electrical or water systems; malfunctioning due to interference, bad or no reception of radio-frequency signals; malfunctioning of the product or parts of it caused by the use of different temperatures or pressures from those detailed in the Jacuzzi Documentation; anomalies of any kind not attributable to product manufacturing defects.

12.5. During the period of validity of this warranty, the network of Jacuzzi Europe S.p.A. Service Centres is authorised by the purchaser (retailer) to provide the warranty to the end user, even if the request is received from the user directly or via an intermediary. It is however understood that the purchaser (retailer) is directly responsible towards the end user for ascertained lack of product conformity, as required by law. The warranty is void if the end user or a delegate thereof does not allow the authorised Jacuzzi Europe S.p.A. technical personnel to perform any reasonable conformity and/or functional verification of the product, or if the products replaced under warranty are not returned to Jacuzzi Europe S.p.A.

12.6. The following are also not covered by the warranty: damages due to non-use of the product; loss of profits and damages of any kind, indirect and consequential; damages caused by the use of non-original Jacuzzi Europe S.p.A. accessories; consumables and parts subject to normal wear and usage due to the use or non-use of the product; damages caused by exceptional atmospheric phenomena or, nonetheless, not due to the normal product functioning; damages caused by water type or impurities in the water or from use of unsuitable and/or non-compliant with the requirements of the Jacuzzi Documentation.

12.7. Performance in accordance with the obligations under this warranty does not extend the original warranty period. In any case, this is without prejudice to the mandatory legal rights of the end user (consumer). This warranty cannot be suspended or prolonged as a result of non-use of the product. Jacuzzi Europe S.p.A. declines all liability for any damage that may be caused, directly or indirectly, to people, properties and animals, due to the failure to comply with all the instructions given in the Jacuzzi Documentation and if the regulations of the country of purchase require that the Products must comply with different and/or more restrictive regulatory requirements than those prescribed by the EU regulations as per point 12.1.

12.8. Under penalty of forfeiture of this warranty, the buyer (reseller) is not allowed to store the products for more than twenty-four (24) months from the date of delivery of the product to the latter. Jacuzzi Europe S.p.A. reserves the right to exercise the right of recourse against the purchaser (retailer) for any services due and made under warranty to the end user on such equipment, with full charge of any and all charges relating thereto.

#### Art. 13 Return of goods

13.1. The return of any materials must be previously authorized by Jacuzzi Europe S.p.A. in writing. Only products with their original packaging can be returned which have not yet been used, and whose model is still being produced and that were delivered not more than 12 months ago.

13.2. Products, which are not in the catalogue, that have been made according to specifications from the purchaser (retailer) will not be returned.

13.3. The cost of returning goods, to be borne by the purchaser (retailer) who will be charged for re-storage, will be a sum not exceeding 25% of the value of the returned goods.

#### Art. 14 Interpretation – Modifications

14.1. Any reference to Jacuzzi Europe S.p.A. price lists, general terms or other materials refers to the documents in force at the time of the same reference, unless otherwise specified.

14.2. Except for cases provided for under the current general terms, any modification carried out by parties to the contracts to which the current general terms apply must be in writing, or will be null and void. The exception to one or more provisions of the current general terms must be interpreted extensively, or by analogy, and does not mean the general terms, as a whole, will cease to apply.

#### Art. 15 Controversies

15.1. For any controversy related, or connected, to the contracts to which the current terms are applied the Court of Pordenone has exclusive jurisdiction, also in the event of payment being agreed by means of bills of exchange.

### Art. 1 Allgemeine Bestimmungen

1.1. Die vorliegenden allgemeinen Verkaufsbedingungen regeln alle derzeitigen und zukünftigen Verkaufsverträge zwischen den Parteien, mit Ausnahme eventueller besonderer, schriftlich vereinbarter Abweichungen.

### Art. 2 Entstehung und Vertragsgegenstand

2.1 Jeder Auftrag wird erst nach schriftlicher Bestätigung der Jacuzzi Europe Sp.A. rechtskräftig. Die Auftragsbestätigung seitens der Jacuzzi Europe Sp.A. kann auch durch die Ausführung derselben erfolgen.

### Art. 3 Lieferung

3.1 Unter Vorbehalt schriftlicher Zusatzvereinbarungen, versteht sich die Übergabe "ab Werk" von Valvasone (Pn) – Italien. Falls der Käufer (Wiederverkäufer) die Abholung nicht veranlasst, hat die Jacuzzi Europe Sp.A. die Befugnis, einen Vertrauenspediteur mit dem Transport zu beauftragen. Bei nicht erfolgter Abholung der Ware gehen die Lagerkosten zu Lasten des Käufers (Wiederverkäufers).

3.2 Die vereinbarten Liefertermine sind Richtdaten. Im Falle einer Verspätung kann der Käufer (Wiederverkäufer) daher keine Schadenersatzforderung geltend machen.

### Art. 4 Verpackungen

4.1 Die Verpackungen der Anlagen entsprechen den internationalen Normen für den Warentransport mit Kraftfahrzeugen auf dem Festland. Vom Standard abweichende Verpackungen bringen eine bei Auftragserteilung zu vereinbarende Preiserhöhung mit sich.

### Art. 5 Auftragsstornierung

5.1 Der Auftrag des Käufers (Wiederverkäufers) stellt eine feste Kaufvereinbarung dar. Kein Auftrag kann ohne die schriftliche Einwilligung der Jacuzzi Europe Sp.A. storniert werden. Bei Auftragsstornierung behält sich die Jacuzzi Europe Sp.A. das Recht vor, Schadenersatz zu fordern.

### Art. 6 Planung – Technisches Datenblatt

6.1 Die Jacuzzi Europe Sp.A. behält sich das Recht vor, die Herstellung jeglicher Modelle ohne vorherige Benachrichtigung einzustellen, bzw. Änderungen bei der Herstellung gewisser Modelle vorzunehmen, ohne deshalb verpflichtet zu sein, diese Veränderungen auch an den vorherigen (verkauften) Modellen vorzunehmen.

6.2 Die in den technischen Unterlagen und Werbemitteln der Jacuzzi Europe Sp.A. beinhaltenen Daten und Eigenschaften (Kataloge, Lehrbücher, Werbeproschüren, Abbildungen, Preislisten) können Veränderungen unterliegen und sind unverbindlich.

### Art. 7 Preise

7.1 Die rechtsgültigen Preise, ausschl. MwSt., sind auf der z.Z. der Bestellung gültigen Preisliste angegeben und verstehen sich für "ab Werk" von Valvasone (Pn) – Italien gelieferte Ware, vorbehaltlich anderer Vereinbarungen.

7.2 Die Preise, die Kursnotierungen und die Rabatte können, ohne vorherige Benachrichtigung seitens der Jacuzzi Europe Sp.A., Änderungen unterliegen.

7.3 Alle nach der erfolgten Preislistenänderung erhaltenen Aufträge und die bei der Mitteilung der Änderung über dreißig Tage hinaus disponierten Speditionen, unterliegen den neuen Preisen.

### Art. 8 Zahlung

8.1 Die Zahlung der Ware wird nur nach erfolgter Guthchrift der betreffenden Beträge an die Jacuzzi Europe Sp.A., als beglichen erachtet.

8.2 Eine Verspätung oder Unregelmäßigkeit der Zahlung jeglicher Art, gibt der Jacuzzi Europe Sp.A. das Recht, die Lieferungen einzustellen oder die noch laufenden Verträge aufzulösen, auch wenn sie nicht die in Frage stehenden Zahlungen anbelangt, vorbehaltlich eventueller Schadenersatzforderungen (einschließlich die der Währungsentwertung). Die Jacuzzi Europe Sp.A. hat in jedem Fall das Recht – nach Ablauf der Rechnungsfälligkeit, ohne die Notwendigkeit in Verzug zu setzen – auf die gesetzlichen, um 5 (fünf) Prozent erhöhten Zinsen.

8.3 Der Käufer (Wiederverkäufer) ist auch im Falle einer Beanstandung oder Streitigkeit zur vollständigen Zahlung verpflichtet. Ein Ausgleich mit eventuellen Forderungen gegenüber der Jacuzzi Europe Sp.A. wird, außer bei schriftlicher Einwilligung, nicht zugelassen.

8.4 Bei offenstehender Begleichung, bzw. auch nur Teilzahlung, hat die Jacuzzi Europe Sp.A. die Befugnis – nach ihrem eigenen Ermessen – vom Käufer (Wiederverkäufer) die ganze Vertragssumme zu fordern, bzw. den Vertrag als aufgelöst zu erklären. Weiterhin besteht das Recht der Rückforderung der gelieferten Ware, Jacuzzi Europe Sp.A. kann zum Schadenersatz die bis dahin gutgeschriebenen Beträge einbehalten, unter Vorbehalt jeglicher weiterer Schritte für höhere Schäden.

### Art. 9 Eigentumsvorbehalt

9.1 Falls die Bezahlung – teilweise oder ganz – nach der Lieferung erfolgen sollte, bleiben die Produkte, laut Verordnung des Art.1523 des ZGB, im Besitz der Jacuzzi Europe Sp.A. bis zum Augenblick der vollständigen Rechnungsbegleichung.

9.2 Aufgrund des vorgenannten Eigentumsvorbehalts wird der Jacuzzi Europe Sp.A. das Recht zugestanden, die Sicherstellung der eventuell unbezahlten Ware zu veranlassen; in diesem Fall gehen die gesamten Unkosten zu Lasten des Käufers (Wiederverkäufers) und die Jacuzzi Europe Sp.A. kann eventuelle schon bezahlte Beträge als Schadenersatz einbehalten. Falls der Käufer (Wiederverkäufer) die betreffende Ware an Dritte verkauft haben sollte, werden die Rechte der Jacuzzi Europe Sp.A., aufgrund der vorliegenden Klausel, auf den durch den Verkauf derselben Ware erzielten Gewinn übertragen.

### Art. 10 Höhere Gewalt und übermäßige Belastung

10.1 Gründe zur Verantwortungsbefreiung sind Ereignisse wie Brand, Zusammenbruch, Überflutung, Versorgungsausfall, Transportwierigkeiten, Streiks, Aussperrungen oder von höherer Gewalt hervorgerufene Ereignisse, die die Produktion der Jacuzzi Europe Sp.A. oder die ihrer Lieferanten merklich verhindern oder einschränken, sowie den Transport der verkauften Ware stark behindern. Die Vertragsaufhebung, wie auch die Nutzung anderer Abhilfen, mit Ausnahme der Schadenersatzforderung, sind nur dann erlaubt, wenn die Verhinderung mindestens 60 Tage dauert.

10.2 Falls, vor deren Ausführung, die Erfüllung der Pflichten der Jacuzzi Europe Sp.A. - aus irgendwelchem, für einen Unternehmer der Branche mit einer gewöhnlichen Erfahrung unvorhergesehenen Grund – im Verhältnis zur ursprünglich vereinbarten Gegenleistung zu belastend geworden ist – so dass dasselbe Verhältnis in einem Maße von 20% oder mehr Prozent verändert wird – kann die Jacuzzi Europe Sp.A. eine Überprüfung der Vertragsbedingungen fordern, oder bei fehlender Vereinbarung den Vertrag als aufgelöst erklären.

### Art. 11 Beschwerden

11.1 Der Käufer (Wiederverkäufer) ist verpflichtet, eventuelle Mängel des Produkts, oder Lieferabweichungen, die sofort bei Erhalt der Ware erhoben werden können – schriftlich und ausführlich zu beanstanden, anderenfalls wird die Beanstandung nicht zur Kenntnis genommen – innerhalb von 8 Tagen ab dem Datum der Übergabe der Ware.

11.2 Eventuelle, nicht infolge der Warenüberprüfung gemäß Abschnitt 11.1 erkennbare Übereinstimmungs-mängel müssen vom Käufer innerhalb der gesetzlichen Fristen, die im Augenblick, wenn ihm die Ware zur Verfügung gestellt wird, beginnen, gemeldet werden, anderenfalls führt sie zum Verfall jeglicher Ansprüche.

### Art. 12 Garantie

12.1 In Übereinstimmung mit dem Inhalt seiner vertraglichen Garantiebedingungen garantiert Jacuzzi Europe Sp.A. für die Produkte der Marke Jacuzzi® bzw. die von Jacuzzi Europe Sp.A. über das Vertriebsnetz der Marke Jacuzzi® vertriebenen Produkte (im Folgenden die „Produkte“), die innerhalb der Mitgliedsstaaten der Europäischen Union gekauft, installiert und für private Zwecke genutzt werden, gegen Konformitätsmängel. Eine eventuelle unternehmerische oder professionelle Verwendung durch den Verbraucher ist von der Garantie ausgeschlossen.

Die vertragliche Garantie findet ausschließlich in dem Mitgliedsland der Europäischen Union Anwendung, in dem die Produkte vom Einzelhändler erworben wurden (im Folgenden das „Erwerbsland“). Produkte, die in einem anderen als dem Erwerbsland installiert werden, sind von keiner vertraglichen Garantie gedeckt. Für Produkte, die außerhalb der Europäischen Union gekauft oder auf jeden Fall verwendet werden, geht die Last der Garantie und der daraus resultierenden Maßnahmen, die notwendig sind, um Konformitätsmängel der Geräte zu beheben, ausschließlich und vollständig zu Lasten des Käufers (Einzelhändler), der daher eine eigene technische Kundendienstorganisation einrichten muss, sofern nicht schriftlich etwas anderes mit Jacuzzi Europe Sp.A. vereinbart wurde.

Die vertragliche Garantie findet außerdem keine Anwendung, wenn die Rechtsvorschriften des Erwerbslandes vorschreiben, dass die Produkte andere und/oder strengere rechtliche Anforderungen erfüllen müssen als vom Gemeinschaftsrecht vorgesehen, und kann nur unter der Voraussetzung angewandt werden, dass Jacuzzi Europe Sp.A. im „Erwerbsland“ über ein Vertrags-Servicezentrum verfügt.

Die angegebenen Daten und Eigenschaften sind für Jacuzzi Europe Sp.A. unverbindlich.

Sie behält sich das Recht vor, ohne Mitteilungs- oder Ersatzpflicht die angemessenen Änderungen vorzunehmen.

Die Garantie, die mit dem Datum der Lieferung des Produkts an den Endbenutzer beginnt, ist nur mit der Zahlung des Gesamtpreises des Geräts wirksam, vorausgesetzt, dass der Eingriff durch von Jacuzzi Europe Sp.A. autorisiertes Fachpersonal durchgeführt wird. Die Garantie gilt für einen Zeitraum von: a) zwölf (12) Monaten für Produkte, die in Geschäftsräumen, Messen, Ausstellungshallen oder anderen Verkaufs-/Werbeveranstaltungen ausgestellt sind, mit Ausnahme von Schäden, die direkt und/oder indirekt am Produkt durch seine verlängerte Ausstellung oder durch seinen Transport/Aus-/Einbau von einem Ausstellungsort zum anderen verursacht werden; b) vierundzwanzig (24) Monate für andere als die in Abschnitt a) genannten Produkte. Diese Garantie erstreckt sich nicht auf Produkte, die seit mehr als vierundzwanzig (24) Monaten nicht mehr produziert werden oder veraltet sind, d. h. Produkte von Jacuzzi Europe Sp.A., die mehr als sechzig (60) Monate nach dem Herstellungsdatum gekauft wurden. Jacuzzi Europe Sp.A. behält sich das Recht vor, zu prüfen, ob das Produkt unter diese Garantie fällt.

12.2 Die Garantie gilt nur, wenn die Installation und der Anschluss des Produkts an das Strom- und Wasser-Netz unter strikter Einhaltung der Anweisungen und Vorschriften erfolgt, die in der Gebrauchsanweisung von Jacuzzi Europe Sp.A. und/oder in einer ihrer Dokumentationen enthalten sind, die Warnhinweise für die Installation, den Gebrauch und die Wartung des Produkts enthalten (im Folgenden „Jacuzzi-Dokumentation“). Befindet sich das Produkt an einem mit den üblichen Verkehrsmitteln schwer zu erreichenden Ort (z. B. Gebirgsorte oder kleinere Inseln), oder wurde es an einer nicht einfach zugänglichen Stelle und/oder mit besonders hochwertigen Materialien installiert, gehen alle Kosten (Lohn- und Materialkosten einschließlich Aus- und Wiedereinbau, Entfernung und Neupositionierung des Produkts und seiner Komponenten) vollständig zu Lasten des Käufers (Einzelhändler), sofern dieser verantwortlich ist, oder des Verbrauchers; in keinem Fall haftet Jacuzzi Europe Sp.A. für die genannten höheren Kosten. Die Garantie verfällt, wenn Komponenten oder andere Teile des Produkts verändert werden und nicht mehr ihrem ursprünglichen Lieferzustand entsprechen.

12.3 Der vollständige oder teilweise Austausch des Geräts (durch das gleiche Produkt oder durch ein anderes mit ähnlichen Eigenschaften), kann nicht durchgeführt werden, wenn dies objektiv unmöglich oder übermäßig teuer im Vergleich zur Reparatur ist, oder wenn es für Jacuzzi Europe Sp.A. im Vergleich zu seiner Reparatur unverhältnismäßige Kosten verursacht, unter Berücksichtigung des Wertes, den das Produkt hätte, wenn es keinen Herstellungsfehler gäbe, des Umfangs des Mangels, der Möglichkeit, dass die alternative Lösung ohne erhebliche Unannehmlichkeiten für den Endbenutzer durchgeführt werden kann. Wenn während der Gültigkeitsdauer dieser Garantie das autorisierte Fachpersonal von Jacuzzi Europe Sp.A. einen zum Zeitpunkt der Lieferung bestehenden Herstellungsfehler des Produkts feststellt und Jacuzzi Europe Sp.A. die Rücksendung im Voraus genehmigt, erstattet letzteres dem Käufer (Einzelhändler) den Preis des Produkts, wie in der von Jacuzzi Europe Sp.A. ausgestellten Verkaufsrechnung angegeben.

12.4 Von der Garantie sind Konformitätsmängel ausgeschlossen, die auf Ursachen zurückzuführen sind, für die nicht Jacuzzi Europe Sp.A. verantwortlich ist, wie zum Beispiel: nicht korrekte und/oder nicht sorgfältige regelmäßige Wartung des Produkts; unsachgemäße Verwendung oder nicht dem Produkt entsprechende Verwendung gemäß den Angaben in der Jacuzzi-Dokumentation oder Unter Verletzung der technischen und/oder sicherheitstechnischen Maßnahmen, die im Land der Verwendung durch die dort geltenden Gesetze, Vorschriften und Bestimmungen erforderlich sind; unsachgemäße und/oder falsche Verbindung und/oder Einstellung der Produktparameter; Verwendung von Nichtoriginalersatzteilen; Transportschäden, die nicht im Rahmen der gesetzlichen Bestimmungen bestritten werden oder durch nicht von Jacuzzi Europe Sp.A. autorisierte Transportmittel verursacht wurden; Ineffizienzen oder Anomalien in Elektro- und Wassersystemen; Fehlbetriebe durch Störungen, schlechten oder Nicht-Empfang von Hochfrequenzsignalen; Fehlbetriebe des Produktes oder seiner Bestandteile, die durch die Verwendung von anderen als den in der Jacuzzi-Dokumentation angegebenen Temperaturen oder Druckwerten verursacht werden; Störungen jeder Art, die nicht auf Herstellungsfehler des Produktes zurückzuführen sind.

12.5 Während der Gültigkeitsdauer der vorliegenden Garantie ist das Netzwerk der Jacuzzi Europe Sp.A. Servicezentren vom Käufer (Einzelhändler) autorisiert, die Garantie dem Endbenutzer gegenüber zu gewähren, auch wenn die Anfrage vom Benutzer selbst oder von einem Vermittler eingeht. Es versteht sich jedoch, dass die unmittelbare Verantwortung gegenüber dem Endbenutzer für festgestellte Konformitätsmängel des Produkts beim Käufer (Einzelhändler) liegt, wie gesetzlich vorgeschrieben. Die Garantie erlischt, wenn der Endbenutzer oder sein Vertreter es dem autorisierten Fachpersonal von Jacuzzi Europe Sp.A. nicht gestattet, eine angemessene Konformitäts- und/oder Funktionsprüfung des Produkts durchzuführen, oder wenn die im Rahmen der Garantie ersetzten Produkte nicht an Jacuzzi Europe Sp.A. zurückgegeben werden.

12.6 Nicht unter diese Garantie fallen: Schäden, die durch Nichtbenutzung des Produkts verursacht werden; entgangener Gewinn und jegliche Art von indirekten oder Folgeschäden; Schäden, die durch die Verwendung von Nichtoriginalzubehör von Jacuzzi Europe Sp.A. verursacht werden; Verbrauchsmaterialien und Teile, die durch die Verwendung oder Nichtbenutzung des Produkts normalen Verschleiß unterliegen; Schäden, die durch außergewöhnliche Wetterbedingungen verursacht werden oder in jedem Fall nicht vom normalen Betrieb des Produkts abhängen; Schäden, die durch die Art von Wasser oder Wasserverunreinigungen oder durch die Verwendung von ungeeigneten Produkten und/oder Produkten verursacht werden, die nicht den Anforderungen der Jacuzzi-Dokumentation entsprechen.

12.7 Die in Erfüllung der in dieser Garantie festgelegten Verpflichtungen erbrachten Leistungen verlängern die ursprüngliche Garantiezeit nicht. In jedem Fall bleiben die zwingenden gesetzlichen Rechte des Endbenutzers (Verbrauchers) unberührt. Diese Garantie kann nicht aufgrund einer Nichtverwendung des Produkts aufgehoben oder verlängert werden. Jacuzzi Europe Sp.A. übernimmt keine Haftung für etwaige Personen-, Sach- und Tierschäden, die direkt oder indirekt durch die Missachtung aller in der Jacuzzi-Dokumentation enthaltenen Anweisungen verursacht werden sollten und wenn die Rechtsvorschriften des Erwerbslandes vorschreiben, dass die Produkte andere und/oder strengere rechtliche Anforderungen erfüllen müssen als vom Gemeinschaftsrecht vorgesehen, siehe Punkt 12.1.

12.8 Unter Androhung des Verfalls dieser Garantie ist es dem Käufer (Einzelhändler) nicht gestattet, die Produkte länger als vierundzwanzig (24) Monate nach dem Datum der Lieferung des Produkts an den Käufer zu lagern. Jacuzzi Europe Sp.A. behält sich das Recht vor, das Rückgriffsrecht gegen den Käufer (Einzelhändler) für alle fälligen und als Garantie für den Endbenutzer auf solche Geräte geleisteten Dienstleistungen auszuüben, wobei alle damit verbundenen Kosten in vollem Umfang zu tragen sind.

### Art. 13 Warenrückgabe

13.1 Die Rückerstattung jeglichen Materials muss vorher von der Jacuzzi Europe Sp.A. schriftlich genehmigt werden. Es können nur Produkte in ihrer Originalverpackung, ungebraucht, dessen Modell noch produziert wird und die vor nicht mehr als 12 Monaten ausgeliefert wurden, zurückerstattet werden.

13.2 Die nicht im Katalog aufgeführten Produkte, die auf besondere Anfrage des Käufers (Wiederverkäufers) angefertigt wurden, können nicht zurückerstattet werden.

13.3 Die Kosten der Warenrückgabe gehen zu Lasten des Käufers (Wiederverkäufers), dem für die Neulagerung ein nicht mehr als 25% des zurückerstatteten Warenwertes betragende Summe angerechnet werden kann.

### Art. 14 Interpretierung – Abänderungen







14.1 Jeder Rückgriff auf die Preislisten, allgemeine Bedingungen oder anderes Material der Jacuzzi Europe Sp.A. versteht sich, wenn nicht anders bestimmt in bezug auf die z.Z. des Verweises gültigen Unterlagen.

14.2 Ausgeschlossen von den, in der vorliegenden allgemeinen Verkaufsbedingung vorgesehenen Fällen, muss jede von den Parteien gefertigte Abänderung der Verträge schriftlich erfolgen, anderenfalls wird die Änderung nicht zur Kenntnis genommen. Die Abweichung von einem oder mehreren Bestimmungen der vorliegenden allgemeinen Verkaufsbedingungen darf nicht extensiv oder in Analogie dazu, ausgelegt werden und schließt nicht den Willen ein, die allgemeinen Verkaufsbedingungen in ihrer Gesamtheit aufzuheben.

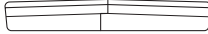
### Art. 15 Streitigkeiten

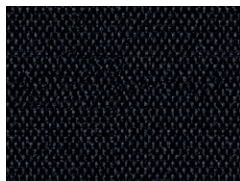
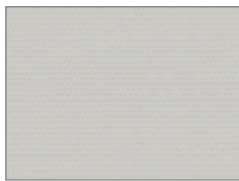
15.1 Für jede diesbezügliche oder mit den Verträgen, denen die vorliegenden Bedingungen zugrunde liegen, verbundenen Streitigkeit ist ausschließlich der Gerichtshof von Pordenone zuständig, auch im Falle einer Bezahlungsvereinbarung durch Wertpapiere.

# INSULATING COVER WÄRMEABDECKUNG

|                              |   |  |
|------------------------------|---|--|
| Collection<br>Kollektion     | J-400™ - J-LX® - J-300™ - J-200™ Classic - SWIM SPA   | DESIGN - PROFESSIONAL - LODGE+   |
| Typology<br>Typologie        | PROLAST™  | PROVINYL   |
| Feature                      | Premium outdoor cover - 25% lighter.<br>Water resistant.<br>Superior UV resistance properties.<br><br>Engineered for durability from superior marine-grade material, Jacuzzi® PROLAST™ Covers are 25% lighter for easier handling and add a premium touch to your outdoor decor.  | Premium outdoor cover.<br>Water resistant.<br>Superior UV resistance properties.<br><br>Engineered for durability from superior marine-grade material, Jacuzzi® Covers are easy to handle and add a premium touch to your outdoor decor.   |
| Feature                      | Premium Außenhülle - 25 % leichter.<br>Wasserdicht.<br>Überlegene UV-Beständigkeitseigenschaften.<br><br>Diese Planen wurden für beste Haltbarkeit aus einem hochwertigen Material aus dem maritimen Einsatzbereich entwickelt. Die Abdeckungen ProLast™ Jacuzzi® sind um 25% leichter, sie sind daher leichter zu handhaben und geben Ihrem Außenbereich einen hochwertigen Touch. | Premium Außenhülle - 25 % leichter.<br>Wasserdicht.<br>Überlegene UV-Beständigkeitseigenschaften.<br><br>Die auf Langlebigkeit ausgelegten Jacuzzi®-Abdeckungen sind aus einem hochwertigen Material, das auch für maritime Anwendungen verwendet wird, sie sind einfach handzuhaben und verleihen Außenmöbeln einen Hauch von Klasse. |
| Foam density<br>Schaumdichte | ~ 24 Kg/m <sup>3</sup>  | ~ 24 Kg/m <sup>3</sup>   |
| Material                     | All-weather PROLAST™ Marine-grade fabric<br>Marinestoff PROLAST™  | Vinyl (PVC plasticized and polyester)<br>Vinyl (Plastifiziertes PVC und Polyester)   |
| Taper<br>Schnittdarstellung  | <br>~ 100 - 65 mm  | <br>~ 100 - 65 mm  |
| Cover handles<br>Griffe      | 6 Exterior + 2 Interior<br>6 Exterior + 2 Interior  | from 2 to 6 Exterior + 2 Interior<br>von 2 bis 6 Exterior + 2 Interior   |
| Color<br>Farben              | J-400™ - J-LX® - J-300™ - J-200™ Classic<br> BLACK<br>SCHWARZ  | DESIGN - PROFESSIONAL<br> ICE  |
|                              | SWIM SPA<br> BROWN<br>BRAUN  | LODGE+<br> GREY<br>GRAU  |
|                              | SWIM SPA<br> GREY<br>GRAU  |  |



# SEATS SITZE

| Number of seats<br>Anzahl der Sitze<br><i>* Lounge</i>  | x 3                   | x 4              | x 5        | x 5-6                         | x 6     | x 6-7                                      | x 8-9      |
|--|-----------------------|------------------|------------|-------------------------------|---------|--|------------|
| J-400™<br>COLLECTION   |                       |                  |            | J-445™*<br>J-435™*            |         | J-485™<br>J-475™*                          | J-495™     |
| J-LX®<br>COLLECTION  |                       |                  |            | J-LXL®*                       |         | J-LX®                                      |            |
| J-300™<br>COLLECTION   | J-315™*               |                  | J-325™     | J-375™*<br>J-355™*<br>J-335™* |         | J-385™<br>J-365™<br>J-345™                 |            |
| J-200™<br>CLASSIC  |                       |                  |            |                               | J-235™* | J-245™                                     |            |
| DESIGN<br>COLLECTION   | Unique*<br>City™ Spa* | Delos*<br>Delfi* | Santorini* | Alimia<br>Profile*            |         | Virtus*                                    |            |
| LODGE+<br>COLLECTION   | Lodge+ S*             |                  | Lodge+ M   | Lodge+ L*                     |         |  |            |
| PROFESSIONAL<br>COLLECTION   |                       |                  |            | Enjoy Pro*                    |         | Virginia Pro*<br>Alimia Pro<br>Virtus Pro* | Sienna Pro |



**DO NOT USE SEA WATER OR WATER WITH ADDED SALT ON ALL HOT TUB AND SWIM SPA MODELS.**

IMAGES ARE PROVIDED BY WAY OF ILLUSTRATION ONLY. They are not binding on Jacuzzi Europe Spa, which reserves the right to make all changes considered appropriate with no need to provide prior notice or replacement.



**ALLE HOT TUB- UND SWIM SPA-MODELLE NICHT MIT MEERWASSER ODER MIT ZUGESETZTEM SALZ VERWENDEN.**

ALLE BILDER UND ABBILDUNGEN DIENEN NUR ILLUSTRATIVEN ZWECKEN. Sie sind nicht bindend für die Gesellschaft Jacuzzi Europe Spa, die sich das Recht vorbehält, alle als zweckmäßig erachteten Änderungen ohne jede Verpflichtung der Vorankündigung oder des Ersatzes vorzunehmen.

# Jacuzzi®

JACUZZI EUROPE S.p.A.

Direzione e Coordinamento  
Jacuzzi Brands, LLC. (USA)

S.S. Pontebbana km 97,200  
33098 Valvasone Arzene (PN) Italia

Via dell'Unione, 1  
20123 Milano (Italia)

Tel. +39 0434 859111  
Fax +39 0434 85278

[info@jacuzzi.eu](mailto:info@jacuzzi.eu)  
[www.jacuzzi.com](http://www.jacuzzi.com)