

Hot Tub and Swim Spa

Price List 2025

01.03.2025
EUR V.A.T. not included
INTERNATIONAL - EN/DE



Sacuzzi®

INDEX REGISTER

HOT TUB AND SWIM SPA COLLECTION

Instructions for ordering
Hinweise zur Bestellung **3**

SmartTub® **5**

new

Infrared technology: a new frontier in wellness
Infrarot-Technologie: Die Wellness hat ein neues
Niveau erreicht **9**

J-400™ COLLECTION

J-495™ **11**

J-485™ **12**

J-475™ **13**

J-445™ **14**

J-435™ **15**

J-LX® COLLECTION

J-LX® **18**

J-LXL® **19**

J-300™ COLLECTION

J-385™ **22**

J-375™ **23**

J-365™ **24**

J-355™ **25**

J-345™ **26**

J-335™ **27**

new

J-332™ **28**

J-325™ **30**

J-315™ **31**

J-200™ CLASSIC COLLECTION

J-235™ Classic **33**

DESIGN COLLECTION

Instructions for ordering
Hinweise zur Bestellung **36**

VIRTUS **37**

PROFILE **38**

SANTORINI **39**

DELOS **40**

DELFI **41**

UNIQUE **42**

CITY™ SPA **43**

ALIMIA **44**

LODGE+ COLLECTION

LODGE+ L **49**

LODGE+ M **50**

LODGE+ S **51**

PROFESSIONAL COLLECTION

VIRTUS PRO **54**

ENJOY PRO **55**

VIRGINIA PRO **56**

SIENNA PRO **57**

ALIMIA PRO **58**

SWIM SPA COLLECTION

new

J-19 DT POWERPRO™ **62**

new

J-19 DT POWERACTIVE™ **63**

J-19 POWERPRO™ **64**

J-19 POWERACTIVE™ **65**

J-16 POWERPRO™ **66**

J-16 POWERACTIVE™ **67**

new

J-14 POWERPRO™ **68**

new

J-14 POWERACTIVE™ **69**

J-13 POWERPLAY™ **70**

Accessories Swim Spa
Zubehör Swim Spa **71**

Outdoor shower column
Duschsäule für Außenbereiche **72**

Accessories Hot Tub
Zubehör Hot Tub **73**

Insulating cover
Wärmeabdeckung **74**

Colors, materials and finishes
Farben, Materialien und Oberflächen **76**

new

General terms of sale
Allgemeine Verkaufsbedingungen **78-79**

COLORS, MATERIALS AND FINISHES FARBEN, MATERIALIEN UND AUSFÜHRUNGEN

Check color availability by model • Kontrollieren Sie die Verfügbarkeit der Farbe pro Modell

SHELL COLOR · FARBEN (SCHALE)

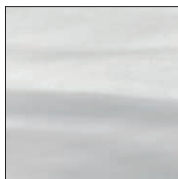

PLATINUM

J-400™ - J-LX® - J-300™
- J-200™ Classic -
DESIGN - LODGE+ -
PROFESSIONAL -
SWIM SPA



**PORCELAIN
(WHITE • WEISS)**

J-LX® - J-300™ Made
in Italy - DESIGN -
LODGE+ -
PROFESSIONAL -
SWIM SPA

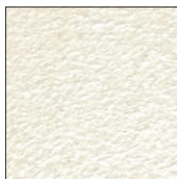

SILVER PEARL

J-400™ - J-300™ -
SWIM SPA

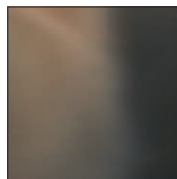

MIDNIGHT

J-400™ - J-300™

CABINET COLOR · PANEELAUSFÜHRUNGEN

PROFINISH™

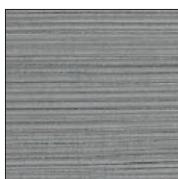

BRUSHED GREY

J-400™ - J-LX® -
J-300™ - SWIM SPA

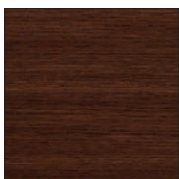

**MODERN
HARDWOOD**

J-400™ - J-LX® -
J-300™ except / außer
Made in Italy



SMOKED EBONY

J-400™ - J-LX® -
J-300™ - SWIM SPA

SYNTHETIC WOOD HOLZIMITAT

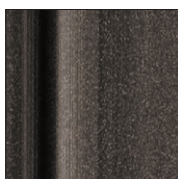

SILVERWOOD

J-200™ Classic
LODGE+

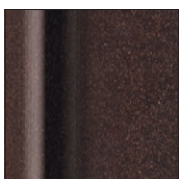

**ROASTED
CHESTNUT**

LODGE+



GRAPHITE

DESIGN: Virtus, Profile,
Santorini, Delos, Delfi,
Alimia

WOOD HOLZ

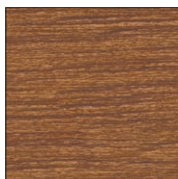

TEAK

DESIGN
Virtus, Santorini,
Delos, Delfi

COMPOSITE-PVC VERBUNDWERKSTOFF-PVC



WHITE OAK

DESIGN
Unique, City™ Spa

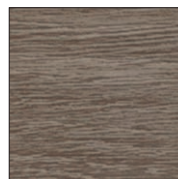

GREY OAK

DESIGN
Unique, City™ Spa

INSULATING COVER · WÄRMEABDECKUNG

PROLAST™



**BLACK
SCHWARZ**

J-400™ - J-LX® -
J-300™ - J-200™ Classic



**GREY
GRAU**

SWIM SPA

PROVINYL



ICE

DESIGN
PROFESSIONAL



**GREY
GRAU**

LODGE +

ROLLAWAY®



**CHARCOAL GREY
ANTHRAZITGRAU**

SWIM SPA



INSTRUCTIONS FOR ORDERING

Dimensions and descriptions are indicated in the master brochure and in this price list.

Orders must include:

- a) name **J-435™**
- b) spa code **YV12RU0EWM T**
- c) cover code **903003420**

NOTE: Optional and accessories marked with dedicated codes to be ordered separately are not included or installed on the product.

HINWEISE ZUR BESTELLUNG

Zur Beschreibung und für die Abmessungen, sollte man sich auf den Katalog und die Preisliste beziehen.

Die Bestellungen sollten folgendes beinhalten:

- a) Name **J-435™**
- b) Artikel-Nr. **YV12RU0EWM T**
- c) Wärmeabdeckung-Nr. **903003420**

NOTE: Optional und accessoires, die mit entsprechenden Codes gekennzeichnet sind, die separat bestellt werden müssen, sind nicht im Produkt inbegriffen oder installiert.



DO NOT USE SEA WATER OR WATER WITH ADDED SALT ON ALL HOT TUB AND SWIM SPA MODELS.

ALLE HOT TUB- UND SWIM SPA-MODELLE NICHT MIT MEERWASSER ODER MIT ZUGESETZTEM SALZ VERWENDEN.

Jacuzzi®

SmartTub[®]

NEW! BLE Connection
-Bluetooth Low Energy-
low energy consumption

NEU! BLE-Verbindung
-Bluetooth Low Energy-
geringer Energieverbrauch

SIMPLIFIED HOT TUB OWNERSHIP

The exclusive patented SmartTub[®] system is engineered to maximize your relaxation, recovery, and energysaving potential.

• NEW

Increase safety and savings with Wireless Sensors for monitoring heat coverage, Hot tub fill level and internal condensation

- Stable, secure, cellular connection. Easy setup, no WiFi credential needed
- Updates made seamlessly over the air
- Remote monitoring
- Reminders
- Power outage notification
- Energy usage estimator*
- Personalized use and care content
- Includes 6 months data plan, \$50/yr

• Compatible with Android, iOS, Alexa, iPad, Apple Watch and Google Assistant



Learn more about SmartTub[®] Technology by visiting www.jacuzzi.com

EINFACHER BESITZ VON WHIRLPOOLS

Patentierte und exklusive Technologie, die sich darauf konzentriert, das absolut beste Erlebnis für den Verbraucher zu bieten.

• NEU

Größere Sicherheit und Ersparnis bei der Nutzung des Spas mit den Wireless-Sensoren für die Kontrolle von Thermodecke, Füllstand und interner Kondensatbildung

- Stabile, sichere und Mobilfunkverbindung. Einfache Einrichtung, keine WiFi-Anmeldung erforderlich
- Nahtlose Updates über das Internet
- System lernt nutzungs basiert
- Enthält einen 1-Jahres-Datenplan, 50 USD/Jahr nach dem Kauf
- Fernüberwachung und Alarme
- Erinnerungen
- Benachrichtigung bei Stromausfall
- Energieverbrauchskalkulator**
- Personalisierte Nutzungs- und Pflegeinhalte

• Kompatibel mit Android, iOS, Alexa, iPad, Apple Watch und Google Assistant



Erfahren Sie mehr über die SmartTub[®] Technology unter www.jacuzzi.com

SmartTub[®] system uses cellular-based communication and requires cell service from our provider partner in your area. See website for details.

* Estimates are based on sensor readings and are not meant to match your utility measurements, see your local utility company for specifics.

Das SmartTub[®]-System nutzt Mobilfunkkommunikation und benötigt einen Mobilfunkdienst unseres Provider-Partners in Ihrer Nähe. Einzelheiten dazu finden Sie auf der Website.

** Erfordert ein Abonnement ab dem zweiten Jahr des Besitzes.

Please, be seated

Decades of expertise drive the Jacuzzi® Hot Tub design process to deliver personalized comfort. The collection of seats in every Jacuzzi® Hot Tub facilitates full-body hydromassage while balancing the flow to each seat for the best experience.

Seats are complemented by jets on the calves and in the foot dome to lift the weight of the day. Smooth surfaces and soft sculpting make it easy to move freely to enjoy all of the seats. Every Jacuzzi® Hot Tub is expertly engineered to nurture your well-being to the core.



FX Therapy Seat

Full Coverage Neck, Shoulder and Back Relief

A collection of 10 to 12 FX Jets deliver a stimulating, spiral-action deep tissue massage to relieve aches from the neck and shoulders through the entire back. Pressure is adjustable for a personalized massage. The J-300™ models feature the Hydrosoothe™ neck-massaging headrest.



MX Therapy Seat

The Original in Low-Back Relief

Ease into this deeply contoured seat to release tension in the lower back with a high-volume, low-pressure massage. Maximized air output delivers a soothing deep tissue massage. Paired with neck jets for a fully relaxing experience.





Foot Dome

Overall Tension Relief

A targeted reflexology massage increases energy, boosts circulation and stimulates nerve function throughout the body. This tension-relieving action induces a deep state of relaxation while keeping you in the perfect position.



RX Therapy Seat

Comforting Back and Shoulder Relief

A ring of spinning RX Jets targets key back and shoulder muscles, drawing on the highest performance hydromassage from the Jacuzzi® Brand to soothe stiff muscles and release tension. Neck jets complement the massage for extra relief.



ProAir™ Lounge

Full-Body Relief

Designed to distribute body weight evenly for a comprehensive massage. The ProAir™ Lounge eases tension in the shoulders and back by combining FX and FX-R rotational jets along the center of the back. Exclusive BX Jets target the calves with an invigorating, bubbly massage and FX Jets penetrate the muscles of the feet with therapeutic relief.



Jacuzzi®

IR

Infrared technology: a new frontier in wellness

Jacuzzi® is the first and only brand to offer Infrared and Red Light technology across a range of wellness products, from Hot Tubs to Swim Spas. Premiering in the J-400™, J-LX® and optional on the models of the J-300™ Collection, the FX-IR Seat combines Infrared and Red Light technology with hydromassage for unmatched rejuvenation.

The therapeutic benefits of hydrotherapy

—
The regeneration power of Infrared and Red Light

—
The regenerative qualities of Infrared and Red Light

—
All working together deep beneath the skin's surface

Infrarot-Technologie: Die Wellness hat ein neues Niveau erreicht

Jacuzzi® hat als erster und bisher einziger Hersteller die Infrarot-Technologie in Wellness-Produkte vom Hot Tub bis zum Swim Spa integriert. Der erstmals mit den Kollektionen J-400™, J-LX® und optional bei den Modellen der J-300™ präsentierte Sitz FX-IR vereint Hydromassage mit Infrarot-Technologie und erzeugt so eine unübertreffliche, verjüngende Wirkung.

—
Die wohltuende Wirkung der Hydrotherapie

—
Die kräftigende Wirkung der Infrarotstrahlen

—
Die regenerierende Wirkung der Infrarot-Technologie

—
Kombinierte Tiefenwirkung bis unter die Haut

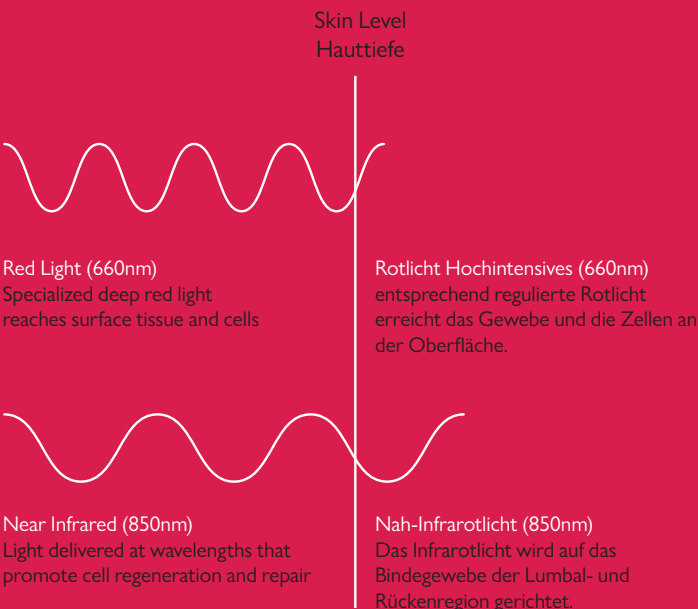

Rejuvenation Meets Relaxation
The rejuvenating powers of Infrared and Red Light technology work together deep beneath the skin's surface to relieve pain, improve range of motion, and reach a state of mindfulness.

Effortless
Only Jacuzzi® offers the joys and benefits of hydrotherapy, Infrared and Red Light technology, effortlessly ready when you are.

Peace of Mind
You can be confident using IR and Red Light technology to enhance your relaxation.

Energie und Entspannung
Die stärkenden Eigenschaften der Infrarot-Technologie wirken gemeinsam unter der Oberfläche und in den tieferen Schichten der Haut. Das lindert Schmerzen, verbessert die Beweglichkeit und trägt dazu bei, wieder in Einklang mit sich selbst zu kommen.

Einfach
Nur Jacuzzi® bietet den Genuss einer wohltuenden Hydrotherapie und der Infrarot-Technologie jederzeit und auf überraschend einfache Weise.

Entspannend
Die Infrarot-Technologie steigert die Entspannung und bietet vollkommene Sicherheit.

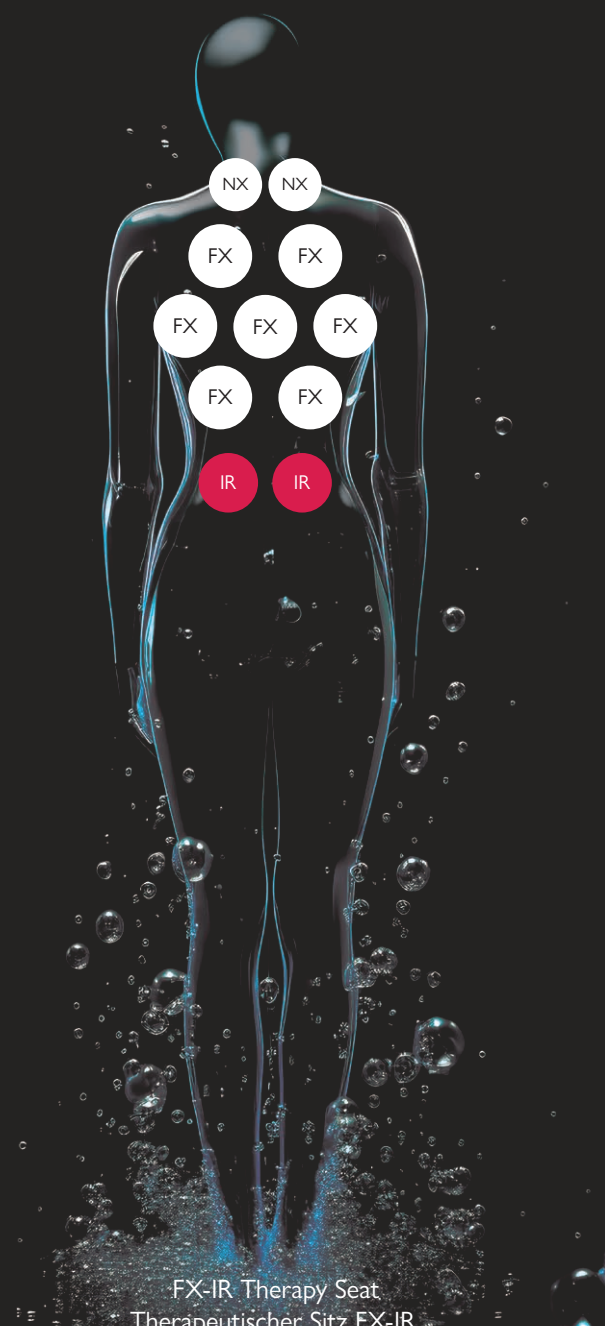

FX-IR Therapy Seat
Therapeutischer Sitz FX-IR

Jacuzzi®

SmartTub®

J-400™



J-495™ LOUNGE
Design Jacuzzi®

SmartTub®

231 x 279 x 95/110 H cm

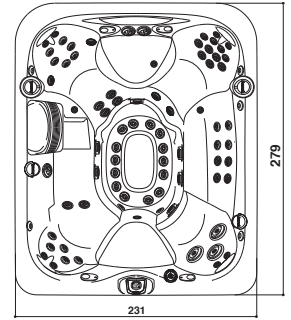

FEATURES • VERSIONEN

		FREESTANDING		
	Seats (total) Sitzflächen (insgesamt)	8 - 9		
	Lounge	1 pivot		
	Jets Düsen	69		
	IR and Red Lights Infrarotlampen und rotes Licht	2		
	WaterColour™ Waterfall WaterColour™ Wasserfall	1		
	Underwater LED multicolor light Mehrfarbige Unterwasser-LED-Leuchte	✓		
	Adjustable headrest Einstellbare Kopfstütze	4		
	ProTouch™ control panel Kontrollanzeige ProTouch™	✓		
	External corner lighting (white LED) Außenecken-Beleuchtung (weiße LED)	✓		
	SmartTub® System	✓		
	Status indicator light Funktionsanzeige	✓		
	CLEARRAY Active Oxygen® System	✓		
	CLEARRAY® System On-demand button • auf Anfrage (mit entsprechendem Druckknopf)	✓		
	Quick drain System Schnelle Entleerung System	✓		

CONFIGURATIONS • KONFIGURATIONEN		FINISHING AUSFÜHRUNGEN	BRUSHED GREY	MODERN HARDWOOD	SMOKED EBONY
	Bluewave™ Stereo System (Wireless + AUX)	Platinum	YR12RU0EWMT	YR12RD0EWMT	YR12RY0EWMT
		Silver Pearl	YR33RU0EWMT	YR33RD0EWMT	YR33RY0EWMT
		Midnight	YR62RU0EWMT	YR62RD0EWMT	YR62RY0EWMT
			€ 36.547		
	Without Stereo System Ohne Stereo System	Platinum	YJ12RU0EWMT	YJ12RD0EWMT	YJ12RY0EWMT
		Silver Pearl	YJ33RU0EWMT	YJ33RD0EWMT	YJ33RY0EWMT
		Midnight	YJ62RU0EWMT	YJ62RD0EWMT	YJ62RY0EWMT
			€ 33.084		

INSULATING COVER to be included in the order • WÄRMEABDECKUNG Muss im Auftrag enthalten sein

	PROLAST™	Black Schwarz	903003260
			€ 2.004

ACCESSOIRES • ZUBEHÖRE

	SmartTub® Three-phase upgrade kit Dreiphasen-Adapter-Kit	919405320
		€ 380
	SmartTub® Wireless Sensor Kit Kit Wireless-Sensoren SmartTub®	919405450
		€ 560
	VersaStep™ Stufe VersaStep™	BRUSHED GREY: 890011360 MODERN HARDWOOD: 890011350 SMOKED EBONY: 890011370
		€ 602
	J-495™ Cover lifter hydraulic assist Hydraulischer Heber für Wärmeabdeckung	890011520
		€ 865
	J-400™ Cover lifter undermount manual Manueller Lift für Wärmeabdeckung	890011500
		€ 865



J-485™
Design Jacuzzi®



231 x 231 x 95/110 H cm

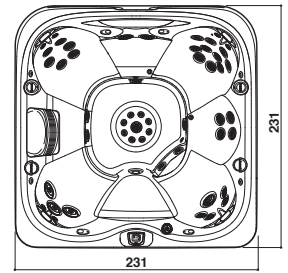

FEATURES • VERSIONEN

		FREESTANDING		
	Seats (total) Sitzflächen (insgesamt)	6-7		
	Lounge	- -		
	Jets Düsen	47		
	IR and Red Lights Infrarotlampen und rotes Licht	2		
	WaterColour™ Waterfall WaterColour™ Wasserfall	1		
	Underwater LED multicolor light Mehrfarbige Unterwasser-LED-Leuchte	✓		
	Adjustable headrest Einstellbare Kopfstütze	4		
	ProTouch™ control panel Kontrollanzeige ProTouch™	✓		
	External corner lighting (white LED) Außenecken-Beleuchtung (weiße LED)	✓		
	SmartTub® System	✓		
	Status indicator light Funktionsanzeige	✓		
	CLEARARRAY Active Oxygen® System	✓		
	CLEARARRAY® System On-demand button • auf Anfrage (mit entsprechendem Druckknopf)	✓		
	Quick drain System Schnelle Entleerung System	✓		

CONFIGURATIONS • KONFIGURATIONEN		FINISHING AUSFÜHRUNGEN	BRUSHED GREY	MODERN HARDWOOD	SMOKED EBONY
	Bluewave™ Stereo System (Wireless + AUX)	Platinum	Y612RU0EWM T	Y612RD0EWM T	Y612RY0EWM T
		Silver Pearl	Y633RU0EWM T	Y633RD0EWM T	Y633RY0EWM T
		Midnight	Y662RU0EWM T	Y662RD0EWM T	Y662RY0EWM T
			€ 33.610		
	Without Stereo System Ohne Stereo System	Platinum	Y512RU0EWM T	Y512RD0EWM T	Y512RY0EWM T
		Silver Pearl	Y533RU0EWM T	Y533RD0EWM T	Y533RY0EWM T
		Midnight	Y562RU0EWM T	Y562RD0EWM T	Y562RY0EWM T
			€ 30.304		

INSULATING COVER to be included in the order • WÄRMEABDECKUNG Muss im Auftrag enthalten sein

	PROLAST™	Black Schwarz	903003330
			€ 1.475

ACCESSOIRES • ZUBEHÖRE

	SmartTub® Three-phase upgrade kit Dreiphasen-Adapter-Kit	919405320
		€ 380
	SmartTub® Wireless Sensor Kit Kit Wireless-Sensoren SmartTub®	919405450
		€ 560
	VersaStep™ Stufe VersaStep™	BRUSHED GREY: 890011360
		MODERN HARDWOOD: 890011350
		SMOKED EBONY: 890011370
		€ 602
	J-400™ Cover lifter hydraulic assist Hydraulischer Heber für Wärmeabdeckung	890011510
		€ 865
	J-400™ Cover lifter undermount manual Manueller Lift für Wärmeabdeckung	890011500
		€ 865



J-475™
Design Jacuzzi®







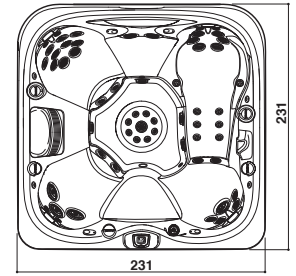











 SmartTub®

231 x 231 x 95/110 H cm



FEATURES • VERSIONEN





		FREESTANDING
	Seats (total) Sitzflächen (insgesamt)	6-7
	Lounge	1
	Jets Düsen	53
	IR and Red Lights Infrarotlampen und rotes Licht	2
	WaterColour™ Waterfall WaterColour™ Wasserfall	1
	Underwater LED multicolor light Mehrfarbige Unterwasser-LED-Leuchte	✓
	Adjustable headrest Einstellbare Kopfstütze	4
	ProTouch™ control panel Kontrollanzeige ProTouch™	✓
	External corner lighting (white LED) Außenecken-Beleuchtung (weiße LED)	✓
	SmartTub® System	✓
	Status indicator light Funktionsanzeige	✓
	CLEARARRAY Active Oxygen® System	✓
	CLEARARRAY® System On-demand button • auf Anfrage (mit entsprechendem Druckknopf)	✓
	Quick drain System Schnelle Entleerung System	✓

CONFIGURATIONS • KONFIGURATIONEN		FINISHING AUSFÜHRUNGEN	BRUSHED GREY	MODERN HARDWOOD	SMOKED EBONY
	Bluewave™ Stereo System (Wireless + AUX)	Platinum	Y412RU0EWM	Y412RD0EWM	Y412RY0EWM
		Silver Pearl	Y433RU0EWM	Y433RD0EWM	Y433RY0EWM
		Midnight	Y462RU0EWM	Y462RD0EWM	Y462RY0EWM
			€ 33.610		
	Without Stereo System Ohne Stereo System	Platinum	Y312RU0EWM	Y312RD0EWM	Y312RY0EWM
		Silver Pearl	Y333RU0EWM	Y333RD0EWM	Y333RY0EWM
		Midnight	Y362RU0EWM	Y362RD0EWM	Y362RY0EWM
			€ 30.304		

INSULATING COVER to be included in the order • WÄRMEABDECKUNG Muss im Auftrag enthalten sein

	PROLAST™	Black Schwarz	903003330
			€ 1.475

ACCESSOIRES • ZUBEHÖRE

	SmartTub® Three-phase upgrade kit Dreiphasen-Adapter-Kit		919405320
			€ 380
	SmartTub® Wireless Sensor Kit Kit Wireless-Sensoren SmartTub®		919405450
			€ 560
	VersaStep™ Stufe VersaStep™		890011360
			€ 602
	J-400™ Cover lifter hydraulic assist Hydraulischer Heber für Wärmeabdeckung		890011510
			€ 865
	J-400™ Cover lifter undermount manual Manueller Lift für Wärmeabdeckung		890011500
			€ 865









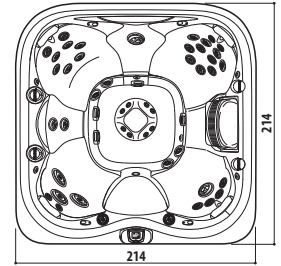







J-445™
Design Jacuzzi®

 SmartTub®

214 x 214 x 95/110 H cm



FEATURES • VERSIONEN





		FREESTANDING		
	Seats (total) Sitzflächen (insgesamt)	6		
	Lounge	- -		
	Jets Düsen	43		
	IR and Red Lights Infrarotlampen und rotes Licht	2		
	WaterColour™ Waterfall WaterColour™ Wasserfall	1		
	Underwater LED multicolor light Mehrfarbige Unterwasser-LED-Leuchte	✓		
	Adjustable headrest Einstellbare Kopfstütze	4		
	ProTouch™ control panel Kontrollanzeige ProTouch™	✓		
	External corner lighting (white LED) Außenecken-Beleuchtung (weiße LED)	✓		
	SmartTub® System	✓		
	Status indicator light Funktionsanzeige	✓		
	CLEARARRAY Active Oxygen® System	✓		
	CLEARARRAY® System On-demand button • auf Anfrage (mit entsprechendem Druckknopf)	✓		
	Quick drain System Schnelle Entleerung System	✓		

CONFIGURATIONS • KONFIGURATIONEN		FINISHING • AUSFÜHRUNGEN	BRUSHED GREY	MODERN HARDWOOD	SMOKED EBONY
	Bluewave™ Stereo System (Wireless + AUX)	Platinum	Y212RU0EWM T	Y212RD0EWM T	Y212RY0EWM T
		Silver Pearl	Y233RU0EWM T	Y233RD0EWM T	Y233RY0EWM T
		Midnight	Y262RU0EWM T	Y262RD0EWM T	Y262RY0EWM T
			€ 29.060		
	Without Stereo System Ohne Stereo System	Platinum	Y112RU0EWM T	Y112RD0EWM T	Y112RY0EWM T
		Silver Pearl	Y133RU0EWM T	Y133RD0EWM T	Y133RY0EWM T
		Midnight	Y162RU0EWM T	Y162RD0EWM T	Y162RY0EWM T
			€ 26.049		

INSULATING COVER to be included in the order • WÄRMEABDECKUNG Muss im Auftrag enthalten sein

	PROLAST™	Black Schwarz	903003420
			€ 1.386

ACCESSOIRES • ZUBEHÖRE

	SmartTub®	Three-phase upgrade kit Dreiphasen-Adapter-Kit	919405320
			€ 380
	SmartTub®	Wireless Sensor Kit Kit Wireless-Sensoren SmartTub®	919405450
			€ 560
	VersaStep™	Stufe VersaStep™	890011360
			€ 602
	J-400™	Cover lifter hydraulic assist Hydraulischer Heber für Wärmeabdeckung	890011510
			€ 865
	J-400™	Cover lifter undermount manual Manueller Lift für Wärmeabdeckung	890011500
			€ 865



J-435™ LOUNGE
Design Jacuzzi®

SmartTub®

214 x 214 x 95/110 H cm

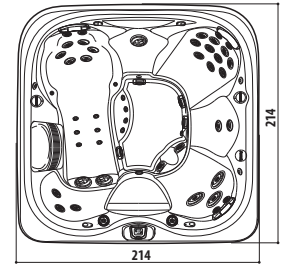

FEATURES • VERSIONEN

		FREESTANDING		
	Seats (total) Sitzflächen (insgesamt)	5-6		
	Lounge	1		
	Jets Düsen	45		
	IR and Red Lights Infrarotlampen und rotes Licht	2		
	WaterColour™ Waterfall WaterColour™ Wasserfall	1		
	Underwater LED multicolor light Mehrfarbige Unterwasser-LED-Leuchte	✓		
	Adjustable headrest Einstellbare Kopfstütze	3		
	ProTouch™ control panel Kontrollanzeige ProTouch™	✓		
	External corner lighting (white LED) Außenecken-Beleuchtung (weiße LED)	✓		
	SmartTub® System	✓		
	Status indicator light Funktionsanzeige	✓		
	CLEARRAY Active Oxygen® System	✓		
	CLEARRAY® System On-demand button • auf Anfrage (mit entsprechendem Druckknopf)	✓		
	Quick drain System Schnelle Entleerung System	✓		

CONFIGURATIONS • KONFIGURATIONEN		FINISHING • AUSFÜHRUNGEN	BRUSHED GREY	MODERN HARDWOOD	SMOKED EBONY
	Bluewave™ Stereo System (Wireless + AUX)	Platinum	YV12RU0EWM T	YV12RD0EWM T	YV12RY0EWM T
		Silver Pearl	YV33RU0EWM T	YV33RD0EWM T	YV33RY0EWM T
		Midnight	YV62RU0EWM T	YV62RD0EWM T	YV62RY0EWM T
			€ 29.060		
	Without Stereo System Ohne Stereo System	Platinum	YU12RU0EWM T	YU12RD0EWM T	YU12RY0EWM T
		Silver Pearl	YU33RU0EWM T	YU33RD0EWM T	YU33RY0EWM T
		Midnight	YU62RU0EWM T	YU62RD0EWM T	YU62RY0EWM T
			€ 26.049		

INSULATING COVER to be included in the order • WÄRMEABDECKUNG **Muss im Auftrag enthalten sein**

	PROLAST™	Black Schwarz	903003420
			€ 1.386

ACCESSOIRES • ZUBEHÖRE

	SmartTub®	Three-phase upgrade kit Dreiphasen-Adapter-Kit	919405320
			€ 380
	SmartTub®	Wireless Sensor Kit Kit Wireless-Sensoren SmartTub®	919405450
			€ 560
	VersaStep™	Stufe VersaStep™	890011360
			€ 602
	J-400™	Cover lifter hydraulic assist Hydraulischer Heber für Wärmeabdeckung	890011510
			€ 865
	J-400™	Cover lifter undermount manual Manueller Lift für Wärmeabdeckung	890011500
			€ 865

Jacuzzi®



J-LX®





J-LX®
Design Jacuzzi®



226 x 226 x 86 H cm

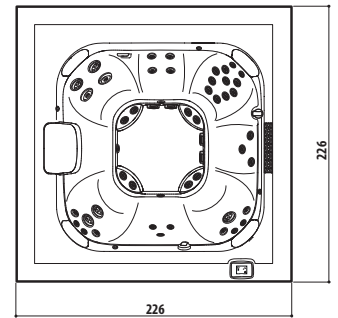

FEATURES • VERSIONEN

		FREESTANDING
	Seats (total) • Sitzflächen (insgesamt)	6-7
	Lounge seat • Lounge Sitzfläche	- -
	Jets • Düsen	39
	IR and Red Lights • Infrarotlampen und rotes Licht	2
	Individual Seat Air Control • Individuelle Kontrolle der Luft über den Sitzflächen	4
	Illuminated Infinity Edge Waterfall • Beleuchteter Wasserfall mit Überlaufwasser	1
	Headrests • Kopfstütze	4
	5-Stage Filtration System • 5-stufiges Wasserfiltersystem	✓
	ProClear® Filter • ProClear® Filter	✓
	CLEARARRAY Active Oxygen® System	✓
	CLEARARRAY® System On-demand button • auf Anfrage (mit entsprechendem Druckknopf)	✓
	ProStream™ Filtration Pump • Filterpumpe ProStream™	✓
	Floating Propolymer Foundation • Schwimmende Propylen-Basis	✓
	Energy efficient with multi-layer insulation • Energieeffizienz mit Mehrschichtisolierung	✓
	Tool-Free Cabinetry • Paneel mit einfacher Öffnung (kein Werkzeug erforderlich)	✓
	Interior Dual multicolor LED Lighting • Mehrfarbige, doppelte LED-Innenbeleuchtung	✓
	External corner lighting (white LED) • Außenecken-Beleuchtung (weiße LED)	✓
	SmartTub® System	✓
	ProTouch™ Touch Screen Controls • Kontrollanzeige ProTouch™	✓
	Quick drain System • Schnelle Entleerung System	✓
	ProLast™ Last • Wärmeabdeckung ProLast™	Black • Schwarz

CONFIGURATIONS • KONFIGURATIONEN

	FINISHING AUSFÜHRUNGEN	BRUSHED GRAY	MODERN HARDWOOD	SMOKED EBONY
			Without Stereo System Ohne Stereo System	YY12RU0EMT
	Platinum	YY76RU0EMT	YY76RD0EMT	YY76RY0EMT
	Porcelain (White • Weiss)	YY76RU0EMT	YY76RD0EMT	YY76RY0EMT
€ 25.700				

INSULATING COVER to be included in the order • WÄRMEABDECKUNG Muss im Auftrag enthalten sein

	PROLAST™	Black • Schwarz	903003950 € 1.500
--	----------	-----------------	----------------------

ACCESSOIRES • ZUBEHÖRE

	SmartTub® Three-phase Upgrade Kit • Dreiphasen-Adapter-Kit		919405320 € 380
	SmartTub® Wireless Sensor Kit • Kit Wireless-Sensoren SmartTub®		919405450 € 560
	VersaStep™ • Stufe VersaStep™	ProFinish®	BRUSHED GRAY 890011360
			MODERN HARDWOOD 890011350
			SMOKED EBONY 890011370
			€ 602
	Cover lifter manual • Manueller Lift für Wärmeabdeckung		890011450 € 541
	Cover lifter hydraulic assist • Hydraulischer Heber für Wärmeabdeckung		890011460 € 757
	Cover lifter undermount manual • Manueller Lift für Wärmeabdeckung		890011500 € 865



J-LXL®
Design Jacuzzi®







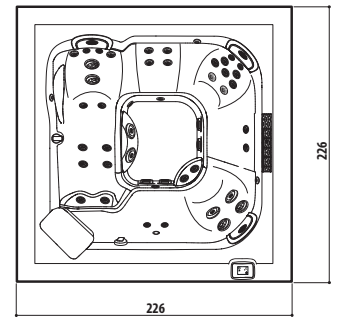















 **SmartTub®**

226 x 226 x 86 H cm



FEATURES • VERSIONEN

		FREESTANDING
	Seats (total) • Sitzflächen (insgesamt)	5-6
	Lounge seat • Lounge Sitzfläche	1
	Jets • Düsen	41
	IR and Red Lights • Infrarotlampen und rotes Licht	2
	Individual Seat Air Control • Individuelle Kontrolle der Luft über den Sitzflächen	3
	Illuminated Infinity Edge Waterfall • Beleuchteter Wasserfall mit Überlaufwasser	1
	Headrests • Kopfstütze	3
	5-Stage Filtration System • 5-stufiges Wasserfiltersystem	✓
	ProClear® Filter • ProClear® Filter	✓
	CLEARARRAY Active Oxygen® System	✓
	CLEARARRAY® System On-demand button • auf Anfrage (mit entsprechendem Druckknopf)	✓
	ProStream™ Filtration Pump • Filterpumpe ProStream™	✓
	Floating Propolymer Foundation • Schwimmende Propylen-Basis	✓
	Energy efficient with multi-layer insulation • Energieeffizienz mit Mehrschichtisolierung	✓
	Tool-Free Cabinetry • Paneel mit einfacher Öffnung (kein Werkzeug erforderlich)	✓
	Interior Dual multicolor LED Lighting • Mehrfarbige, doppelte LED-Innenbeleuchtung	✓
	External corner lighting (white LED) • Außenecken-Beleuchtung (weiße LED)	✓
	SmartTub® System	✓
	ProTouch™ Touch Screen Controls • Kontrollanzeige ProTouch™	✓
	Quick drain System • Schnelle Entleerung System	✓
	ProLast™ Last • Wärmeabdeckung ProLast™	✓







CONFIGURATIONS • KONFIGURATIONEN

		FINISHING AUSFÜHRUNGEN		
		BRUSHED GRAY	MODERN HARDWOOD	SMOKED EBONY
	Without Stereo System	YW12RU0EMT	YW12RDOEMT	YW12RY0EMT
	Ohne Stereo System	YW76RU0EMT	YW76RDOEMT	YW76RY0EMT
		€ 25.700		

INSULATING COVER to be included in the order • WÄRMEABDECKUNG Muss im Auftrag enthalten sein

	PROLAST™	Black • Schwarz	903003950 € 1.500
---	----------	-----------------	----------------------

ACCESSOIRES • ZUBEHÖRE

	SmartTub® Three-phase Upgrade Kit • Dreiphasen-Adapter-Kit		919405320 € 380						
	SmartTub® Wireless Sensor Kit • Kit Wireless-Sensoren SmartTub®		919405450 € 560						
	VersaStep™ • Stufe VersaStep™	ProFinish®	<table border="1" style="width: 100%; background-color: #0070C0; color: white;"> <tr> <th style="background-color: #0070C0; color: white;">BRUSHED GRAY</th> <th style="background-color: #0070C0; color: white;">MODERN HARDWOOD</th> <th style="background-color: #0070C0; color: white;">SMOKED EBONY</th> </tr> <tr> <td style="background-color: #0070C0; color: white;">890011360</td> <td style="background-color: #0070C0; color: white;">890011350</td> <td style="background-color: #0070C0; color: white;">890011370</td> </tr> </table>	BRUSHED GRAY	MODERN HARDWOOD	SMOKED EBONY	890011360	890011350	890011370
BRUSHED GRAY	MODERN HARDWOOD	SMOKED EBONY							
890011360	890011350	890011370							
	Cover lifter manual • Manueller Lift für Wärmeabdeckung		890011450 € 541						
	Cover lifter hydraulic assist • Hydraulischer Heber für Wärmeabdeckung		890011460 € 757						
	Cover lifter undermount manual • Manueller Lift für Wärmeabdeckung		890011500 € 865						

Jacuzzi®

J-300™



J-332™



J-385™

Design Jacuzzi®



231 x 231 x 95 H cm

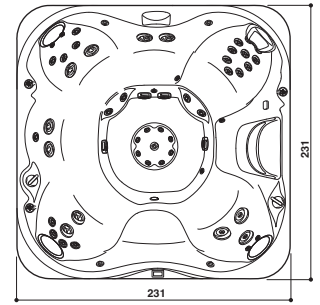

FEATURES • VERSIONEN

		FREESTANDING
	Seats (total) • Sitzflächen (insgesamt)	6-7
	Lounge	--
	Jets • Düsen	51
new	IR and Red Lights • Infrarotlampen und rotes Licht	2
	Waterfall with lights • Beleuchteter Wasserfall	✓
	HydroSoothe™ hydromassage headrest • Hydromassage-Kopfstütze	1
new	Soft and thin headrest • Weiche und dünne Kopfstütze	3
	Underwater LED multicolor light Mehrfarbige Unterwasser-LED-Leuchte	✓
new	Touch Screen Controls • Touch-Bedienelement	✓
new	External corner lighting (white LED) Außenecken-Beleuchtung (weiße LED)	✓
	CLEARRAY Active Oxygen® System	✓
	CLEARRAY® System On-demand button • auf Anfrage (mit entsprechendem Druckknopf)	✓
	SmartTub®	919405440
	Three-phase upgrade kit Dreiphasen-Adapter-Kit	€ 1.202
	Optional	919405320
		€ 380

CONFIGURATIONS • KONFIGURATIONEN

		FINISHING • AUSFÜHRUNGEN			
		BRUSHED GREY	MODERN HARDWOOD	SMOKED EBONY	
	SmartTub® IR and Red Lights Infrarotlampen und rotes Licht	Platinum	Z212RU0EWMT	Z212RD0EWMT	Z212RY0EWMT
		Silver Pearl	Z233RU0EWMT	Z233RD0EWMT	Z233RY0EWMT
		Midnight	Z262RU0EWMT	Z262RD0EWMT	Z262RY0EWMT
		€ 24.045			
	Basic	Platinum	Z212ZU0EWT	Z212ZD0EWT	Z212ZY0EWT
		Silver Pearl	Z233ZU0EWT	Z233ZD0EWT	Z233ZY0EWT
		Midnight	Z262ZU0EWT	Z262ZD0EWT	Z262ZY0EWT
		€ 23.405			

Bluewave™ Stereo System on request - contact the office • auf Anfrage - kontaktieren Sie die Büros

INSULATING COVER to be included in the order • WÄRMEABDECKUNG Muss im Auftrag enthalten sein

	PROLAST™	Black • Schwarz	903002941
			€ 1.491

ACCESSORI

	SmartTub® Wireless Sensor Kit • Kit Wireless-Sensoren SmartTub®	919405450		
		€ 560		
		BRUSHED GREY	MODERN HARDWOOD	SMOKED EBONY
	VersaStep™ • Stufe VersaStep™	890011360	890011350	890011370
		€ 602		
	J-300™ Cover lifter manual drop-behind Manueller Lift für Wärmeabdeckung (hinter dem Whirlpool)	890011440		
		€ 1.310		
	J-300™ Covermate manual Abdeckungsheber J-300™ manuell	890011450		
		€ 541		
	J-300™ Cover lifter hydraulic assist Hydraulischer Heber für Wärmeabdeckung	890011460		
		€ 757		
	J-300™ Covermate manual Abdeckungsheber J-300™ manuell	890011500		
		€ 865		



J-375™



MADE IN ITALY Production from / Produktion ab May 2025

J-375™ LOUNGE
Design Jacuzzi®

SmartTub®

231 x 231 x 95 H cm
231 x 231 x 93 H cm Made in Italy

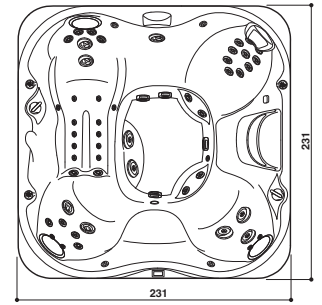

FEATURES • VERSIONEN

	Seats (total) • Sitzflächen (insgesamt)
	Lounge
	Jets • Düsen
	IR and Red Lights • Infrarotlampen und rotes Licht
	Waterfall with lights • Beleuchteter Wasserfall
	HydroSoothe™ hydromassage headrest • Hydromassage-Kopfstütze
	Soft and thin headrest • Weiche und dünne Kopfstütze
	Underwater LED multicolor light Mehrfarbige Unterwasser-LED-Leuchte
	Touch Screen Controls • Touch-Bedienelement
	External corner lighting (white LED) Außenecken-Beleuchtung (weiße LED)
	CLEARRAY Active Oxygen® System
	CLEARRAY® System On-demand button • auf Anfrage (mit entsprechendem Druckknopf)
	SmartTub®
	SmartTub® Three-phase upgrade kit

FREESTANDING		
5-6		
1		
52		
2		
✓		
1		
3		
✓		
✓		
✓		
✓		
919405440		
€ 1.202		
919405320		
€ 380		

CONFIGURATIONS • KONFIGURATIONEN

	FINISHING
SmartTub® IR and Red Lights Bluewave™ Stereo System	Platinum
	Silver Pearl
	Midnight
	Porcelain (White)
SmartTub® IR and Red Lights Infrarotlampen und rotes Licht	Platinum
	Silver Pearl
	Midnight
	Porcelain (White)
IR and Red Lights Infrarotlampen und rotes Licht	Platinum
	Silver Pearl
	Midnight
	Porcelain (White)
Basic	Platinum
	Silver Pearl
	Midnight
	Porcelain (White)

BRUSHED GREY	MODERN HARDWOOD	SMOKED EBONY
ZM12RU0EWM0	-	ZM12RY0EWM0
ZM33RU0EWM0	-	ZM33RY0EWM0
-	-	-
ZM76RU0EWM0	-	ZM76RY0EWM0
€ 26.597	-	€ 26.597
ZG12RU0EWM0	ZG12RD0EWM0	ZG12RY0EWM0
ZG33RU0EWM0	ZG33RD0EWM0	ZG33RY0EWM0
-	ZG62RD0EWM0	-
ZG76RU0EWM0	-	ZG76RY0EWM0
€ 24.787	€ 25.449	€ 24.787
ZG12RU0EWO	-	ZG12RY0EWO
ZG33RU0EWO	-	ZG33RY0EWO
-	-	-
ZG76RU0EWO	-	ZG76RY0EWO
€ 23.897	-	€ 23.897
ZG12ZU0EWO	ZG12ZD0EWT	ZG12ZY0EWO
ZG33ZU0EWO	ZG33ZD0EWT	ZG33ZY0EWO
-	ZG62ZD0EWT	-
ZG76ZU0EWO	-	ZG76ZY0EWO
€ 23.147	€ 23.809	€ 23.147

INSULATING COVER to be included in the order • WÄRMEABDECKUNG Muss im Auftrag enthalten sein

	PROLAST™	Black • Schwarz
--	----------	-----------------

903002941
€ 1.491

ACCESSOIRES • ZUBEHÖRE

	SmartTub® Wireless Sensor Kit • Kit Wireless-Sensoren SmartTub®
	VersaStep™ • Stufe VersaStep™
	J-300™ Cover lifter manual drop-behind Manueller Lift für Wärmeabdeckung (hinter dem Whirlpool)
	J-300™ Covermate manual • Abdeckungsheber J-300™ manuell
	J-300™ Cover lifter hydraulic assist • Hydraulischer Heber für Wärmeabdeckung
	J-300™ Covermate manual • Abdeckungsheber J-300™ manuell

919405450		
€ 560		
BRUSHED GREY	MODERN HARDWOOD	SMOKED EBONY
890011360	890011350	890011370
€ 602		
890011440		
€ 1.310		
890011450		
€ 541		
890011460		
€ 757		
890011500		
€ 865		



MADE IN ITALY

J-375™ CLASSIC

Design Jacuzzi®

SmartTub®

231 x 231 x 93 H cm Made in Italy

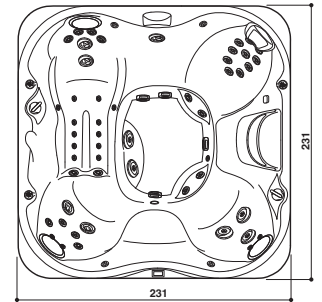

FEATURES • VERSIONEN

		FREESTANDING		
	Seats (total) • Sitzflächen (insgesamt)	5-6		
	Lounge	1		
	Jets • Düsen	52		
	Waterfall with lights • Beleuchteter Wasserfall	✓		
	HydroSoothe™ hydromassage headrest • Hydromassage-Kopfstütze	1		
	Headrest • Kopfstütze	3		
	Underwater LED multicolor light Mehrfarbige Unterwasser-LED-Leuchte	✓		
	LED control panel • LED - Display	✓		
	External corner lighting • Außenecken-Beleuchtung	✓		
	CLEARRAY Active Oxygen® System	✓		
	CLEARRAY® System On-demand button • auf Anfrage (mit entsprechendem Druckknopf)	✓		
	SmartTub®	919405440		
	SmartTub® Three-phase upgrade kit Dreiphasen-Adapter-Kit	Optional € 1.202		
		919405320		
		€ 380		

CONFIGURATIONS • KONFIGURATIONEN

		FINISHING • AUSFÜHRUNGEN			
		BRUSHED GREY	MODERN HARDWOOD	SMOKED EBONY	
	SmartTub® Bluewave™ Stereo System	Platinum	ZM12ZU0EWM40	-	ZM12ZY0EWM40
		Porcelain (White • Weiss)	ZM76ZU0EWM40	-	ZM76ZY0EWM40
		€ 26.597	-	€ 26.597	
	SmartTub®	Platinum	ZG12ZU0EWM40	-	ZG12ZY0EWM40
		Porcelain (White • Weiss)	ZG76ZU0EWM40	-	ZG76ZY0EWM40
		€ 24.037	-	€ 24.037	
	Bluewave™ Stereo System	Platinum	ZM12ZU0EW40	-	ZM12ZY0EW40
		Porcelain (White • Weiss)	ZM76ZU0EW40	-	ZM76ZY0EW40
		€ 25.707	-	€ 25.707	
	Basic	Platinum	ZG12ZU0EW40	-	ZG12ZY0EW40
		Porcelain (White • Weiss)	ZG76ZU0EW40	-	ZG76ZY0EW40
		€ 23.147	-	€ 23.147	

INSULATING COVER to be included in the order • WÄRMEABDECKUNG Muss im Auftrag enthalten sein

	PROLAST™	Black • Schwarz	903002941
			€ 1.491

ACCESSOIRES • ZUBEHÖRE

	SmartTub® Wireless Sensor Kit • Kit Wireless-Sensoren SmartTub®	919405450		
		€ 560		
		BRUSHED GREY	MODERN HARDWOOD	SMOKED EBONY
	VersaStep™ • Stufe VersaStep™	890011360	890011350	890011370
		€ 602		
	J-300™ Cover lifter manual drop-behind Manueller Lift für Wärmeabdeckung (hinter dem Whirlpool)	890011440		
		€ 1.310		
	J-300™ Covermate manual Abdeckungsheber J-300™ manuell	890011450		
		€ 541		
	J-300™ Cover lifter hydraulic assist Hydraulischer Heber für Wärmeabdeckung	890011460		
		€ 757		
	J-300™ Covermate manual Abdeckungsheber J-300™ manuell	890011500		
		€ 865		



J-365™

Design Jacuzzi®



231 x 214 x 95 H cm

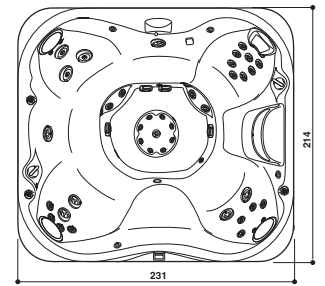

FEATURES • VERSIONEN

		FREESTANDING
	Seats (total) • Sitzflächen (insgesamt)	6-7
	Lounge	- -
	Jets • Düsen	46
new	IR and Red Lights • Infrarotlampen und rotes Licht	2
	Waterfall with lights • Beleuchteter Wasserfall	✓
	HydroSoothe™ hydromassage headrest • Hydromassage-Kopfstütze	1
new	Soft and thin headrest • Weiche und dünne Kopfstütze	3
	Underwater LED multicolor light Mehrfarbige Unterwasser-LED-Leuchte	✓
new	Touch Screen Controls • Touch-Bedienelement	✓
new	External corner lighting (white LED) Außenecken-Beleuchtung (weiße LED)	✓
	CLEARRAY Active Oxygen® System	✓
	CLEARRAY® System On-demand button • auf Anfrage (mit entsprechendem Druckknopf)	✓
	SmartTub®	919405440
	SmartTub® Three-phase upgrade kit Dreiphasen-Adapter-Kit	€ 1.202
	Optional	919405320
		€ 380

CONFIGURATIONS • KONFIGURATIONEN

		FINISHING • AUSFÜHRUNGEN			
		BRUSHED GREY	MODERN HARDWOOD	SMOKED EBONY	
	SmartTub® IR and Red Lights Infrarotlampen und rotes Licht	Platinum	ZF12RU0EWMT	ZF12RD0EWMT	ZF12RY0EWMT
		Silver Pearl	ZF33RU0EWMT	ZF33RD0EWMT	ZF33RY0EWMT
		Midnight	ZF62RU0EWMT	ZF62RD0EWMT	ZF62RY0EWMT
		€ 24.499			
	Basic	Platinum	ZF12ZU0EWT	ZF12ZD0EWT	ZF12ZY0EWT
		Silver Pearl	ZF33ZU0EWT	ZF33ZD0EWT	ZF33ZY0EWT
		Midnight	ZF62ZU0EWT	ZF62ZD0EWT	ZF62ZY0EWT
		€ 22.859			

Bluewave™ Stereo System on request - contact the office • auf Anfrage - kontaktieren Sie die Büros

INSULATING COVER to be included in the order • WÄRMEABDECKUNG Muss im Auftrag enthalten sein

	PROLAST™	Black • Schwarz	903003221
			€ 1.398

ACCESSORI

	SmartTub® Wireless Sensor Kit • Kit Wireless-Sensoren SmartTub®	919405450		
		€ 560		
		BRUSHED GREY	MODERN HARDWOOD	SMOKED EBONY
	VersaStep™ • Stufe VersaStep™	890011360	890011350	890011370
		€ 602		
	J-300™ Cover lifter manual drop-behind Manueller Lift für Wärmeabdeckung (hinter dem Whirlpool)	890011440		
		€ 1.310		
	J-300™ Covermate manual Abdeckungsheber J-300™ manuell	890011450		
		€ 541		
	J-300™ Cover lifter hydraulic assist Hydraulischer Heber für Wärmeabdeckung	890011460		
		€ 757		
	J-300™ Covermate manual Abdeckungsheber J-300™ manuell	890011500		
		€ 865		



J-355™



MADE IN ITALY Production from / Produktion ab May 2025

J-355™ LOUNGE
Design Jacuzzi®

SmartTub®

231 x 214 x 95 H cm
231 x 214 x 93 H cm Made in Italy

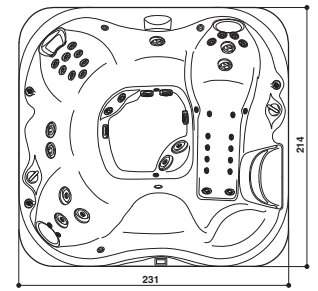

FEATURES • VERSIONEN

	Seats (total) • Sitzflächen (insgesamt)
	Lounge
	Jets • Düsen
	IR and Red Lights • Infrarotlampen und rotes Licht
	Waterfall with lights • Beleuchteter Wasserfall
	HydroSoothe™ hydromassage headrest • Hydromassage-Kopfstütze
	Soft and thin headrest • Weiche und dünne Kopfstütze
	Underwater LED multicolor light Mehrfarbige Unterwasser-LED-Leuchte
	Touch Screen Controls • Touch-Bedienelement
	External corner lighting (white LED) Außenecken-Beleuchtung (weiße LED)
	CLEARARRAY Active Oxygen® System
	CLEARARRAY® System On-demand button • auf Anfrage (mit entsprechendem Druckknopf)
	SmartTub®
	SmartTub® Three-phase upgrade kit

FREESTANDING		
5-6		
1		
44		
2		
✓		
1		
2		
✓		
✓		
✓		
✓		
919405440		
€ 1.202		
919405320		
€ 380		

CONFIGURATIONS • KONFIGURATIONEN

		FINISHING
	SmartTub® IR and Red Lights Bluewave™ Stereo System	Platinum
		Silver Pearl
		Midnight
		Porcelain (White)
	SmartTub® IR and Red Lights Infrarotlampen und rotes Licht	Platinum
		Silver Pearl
		Midnight
		Porcelain (White)
	IR and Red Lights Infrarotlampen und rotes Licht	Platinum
		Silver Pearl
		Midnight
		Porcelain (White)
	Basic	Platinum
		Silver Pearl
		Midnight
		Porcelain (White)

BRUSHED GREY	MODERN HARDWOOD	SMOKED EBONY
ZK12RU0EWM0	-	ZK12RY0EWM0
ZK33RU0EWM0	-	ZK33RY0EWM0
ZK62RU0EWM0	-	ZK62RY0EWM0
ZK76RU0EWM0	-	ZK76RY0EWM0
€ 26.153	-	€ 26.153
ZE12ZU0EWM0	ZE12RD0EWM0	ZE12ZY0EWM0
ZE33ZU0EWM0	ZE33RD0EWM0	ZE33ZY0EWM0
ZE62ZU0EWM0	ZE62RD0EWM0	ZE62ZY0EWM0
ZE76ZU0EWM0	-	ZE76ZY0EWM0
€ 24.347	€ 24.996	€ 24.347
ZK12ZU0EWO	-	ZK12ZY0EWO
ZK33ZU0EWO	-	ZK33ZY0EWO
ZK62ZU0EWO	-	ZK62ZY0EWO
ZK76ZU0EWO	-	ZK76ZY0EWO
€ 23.457	-	€ 23.457
ZE12ZU0EWO	ZE12ZD0EWT	ZE12ZY0EWO
ZE33ZU0EWO	ZE33ZD0EWT	ZE33ZY0EWO
ZE62ZU0EWO	ZE62ZD0EWT	ZE62ZY0EWO
ZE76ZU0EWO	-	ZE76ZY0EWO
€ 22.707	€ 23.356	€ 22.707

INSULATING COVER to be included in the order • WÄRMEABDECKUNG Muss im Auftrag enthalten sein

	PROLAST™	Black • Schwarz
--	----------	-----------------

903003221
€ 1.398

ACCESSOIRES • ZUBEHÖRE

	SmartTub® Wireless Sensor Kit • Kit Wireless-Sensoren SmartTub®
	VersaStep™ • Stufe VersaStep™
	J-300™ Cover lifter manual drop-behind Manueller Lift für Wärmeabdeckung (hinter dem Whirlpool)
	J-300™ Covermate manual • Abdeckungsheber J-300™ manuell
	J-300™ Cover lifter hydraulic assist • Hydraulischer Heber für Wärmeabdeckung
	J-300™ Covermate manual • Abdeckungsheber J-300™ manuell

919405450		
€ 560		
BRUSHED GREY	MODERN HARDWOOD	SMOKED EBONY
890011360	890011350	890011370
€ 602		
890011440		
€ 1.310		
890011450		
€ 541		
890011460		
€ 757		
890011500		
€ 865		



MADE IN ITALY

J-355™ CLASSIC

Design Jacuzzi®

SmartTub®

231 x 214 x 93 H cm Made in Italy

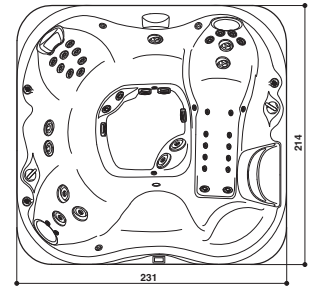

FEATURES • VERSIONEN

		FREESTANDING
	Seats (total) • Sitzflächen (insgesamt)	5-6
	Lounge	1
	Jets • Düsen	44
	Waterfall with lights • Beleuchteter Wasserfall	✓
	HydroSoothe™ hydromassage headrest • Hydromassage-Kopfstütze	1
	Headrest • Kopfstütze	3
	Underwater LED multicolor light Mehrfarbige Unterwasser-LED-Leuchte	✓
	LED control panel • LED - Display	✓
	External corner lighting • Außenecken-Beleuchtung	✓
	CLEARRAY Active Oxygen® System	✓
	CLEARRAY® System On-demand button • auf Anfrage (mit entsprechendem Druckknopf)	✓
	SmartTub®	919405440
	SmartTub® Three-phase upgrade kit Dreiphasen-Adapter-Kit	€ 1.202
	Optional	919405320
		€ 380

CONFIGURATIONS • KONFIGURATIONEN

		FINISHING • AUSFÜHRUNGEN	BRUSHED GREY	MODERN HARDWOOD	SMOKED EBONY
	SmartTub® Bluewave™ Stereo System	Platinum	ZK12ZU0EWM40	-	ZK12ZY0EWM40
		Silver Pearl	ZK33ZU0EWM40	-	ZK33ZY0EWM41
		Midnight	ZK62ZU0EWM40	-	ZK62ZY0EWM40
		Porcelain (White • Weiss)	ZK76ZU0EWM40	-	ZK76ZY0EWM40
			€ 26.153	-	€ 26.153
	SmartTub® Without Stereo System Ohne Stereo System	Platinum	ZE12ZU0EWM40	-	ZE12ZY0EWM40
		Silver Pearl	ZE33ZU0EWM40	-	ZE33ZY0EWM40
		Midnight	ZE62ZU0EWM40	-	ZE62ZY0EWM40
		Porcelain (White • Weiss)	ZE76ZU0EWM40	-	ZE76ZY0EWM40
			€ 23.597	-	€ 23.597
	Bluewave™ Stereo System	Platinum	ZK12ZU0EW40	-	ZK12ZY0EW40
		Silver Pearl	ZK33ZU0EW40	-	ZK33ZY0EW40
		Midnight	ZK62ZU0EW40	-	ZK62ZY0EW40
		Porcelain (White • Weiss)	ZK76ZU0EW40	-	ZK76ZY0EW40
			€ 25.263	-	€ 25.263
	Without Stereo System Ohne Stereo System	Platinum	ZE12ZU0EW40	-	ZE12ZY0EW40
		Silver Pearl	ZE33ZU0EW40	-	ZE33ZY0EW40
		Midnight	ZE62ZU0EW40	-	ZE62ZY0EW40
		Porcelain (White • Weiss)	ZE76ZU0EW40	-	ZE76ZY0EW40
			€ 22.707	-	€ 22.707

INSULATING COVER to be included in the order • WÄRMEABDECKUNG Muss im Auftrag enthalten sein

	PROLAST™	Black • Schwarz	903003221
			€ 1.398

ACCESSOIRES • ZUBEHÖRE

	SmartTub® Wireless Sensor Kit • Kit Wireless-Sensoren SmartTub®		919405450
			€ 560
			BRUSHED GREY
			MODERN HARDWOOD
			SMOKED EBONY
	VersaStep™ • Stufe VersaStep™		890011360
			890011350
			890011370
			€ 602
	J-300™ Cover lifter manual drop-behind Manueller Lift für Wärmeabdeckung (hinter dem Whirlpool)		890011440
			€ 1.310
	J-300™ Covermate manual Abdeckungsheber J-300™ manuell		890011450
			€ 541
	J-300™ Cover lifter hydraulic assist Hydraulischer Heber für Wärmeabdeckung		890011460
			€ 757
	J-300™ Covermate manual Abdeckungsheber J-300™ manuell		890011500
			€ 865



J-345™

Design Jacuzzi®



214 x 214 x 91 H cm

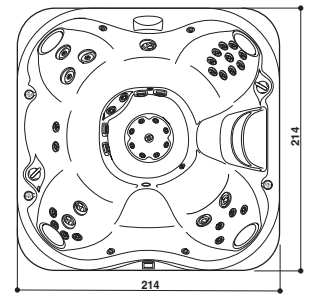

FEATURES • VERSIONEN

	Seats (total) • Sitzflächen (insgesamt)
	Lounge
	Jets • Düsen
new	IR and Red Lights • Infrarotlampen und rotes Licht
	Waterfall with lights • Beleuchteter Wasserfall
	HydroSoothe™ hydromassage headrest • Hydromassage-Kopfstütze
new	Soft and thin headrest • Weiche und dünne Kopfstütze
	Underwater LED multicolor light Mehrfarbige Unterwasser-LED-Leuchte
new	Touch Screen Controls • Touch-Bedienelement
new	External corner lighting (white LED) Außenecken-Beleuchtung (weiße LED)
	CLEARARRAY Active Oxygen® System
	CLEARARRAY® System On-demand button • auf Anfrage (mit entsprechendem Druckknopf)

FREESTANDING

	6-7
	--
	41
	2
	✓
	1
	3
	✓
	✓
	✓
	✓

	SmartTub®		919405440
	SmartTub®	Optional	€ 1.202
	Three-phase upgrade kit Dreiphasen-Adapter-Kit		919405320
			€ 380

CONFIGURATIONS • KONFIGURATIONEN

		FINISHING • AUSFÜHRUNGEN	BRUSHED GREY	MODERN HARDWOOD	SMOKED EBONY
	SmartTub® IR and Red Lights Infrarotlampen und rotes Licht	Platinum	ZD12RU0EWMT	ZD12RD0EWMT	ZD12RY0EWMT
		Silver Pearl	ZD33RU0EWMT	ZD33RD0EWMT	ZD33RY0EWMT
		Midnight	ZD33RY0EWMT	ZD62RD0EWMT	ZD62RY0EWMT
			€ 23.042		
	Basic	Platinum	ZD12ZU0EWT	ZD12ZD0EWT	ZD12ZY0EWT
		Silver Pearl	ZD33ZU0EWT	ZD33ZD0EWT	ZD33ZY0EWT
		Midnight	ZD62ZU0EWT	ZD62ZD0EWT	ZD62ZY0EWT
			€ 21.402		

Bluewave™ Stereo System on request - contact the office • auf Anfrage - kontaktieren Sie die Büros

INSULATING COVER to be included in the order • WÄRMEABDECKUNG Muss im Auftrag enthalten sein

	PROLAST™	Black • Schwarz	903002411
			€ 1.395

ACCESSORI

	SmartTub® Wireless Sensor Kit • Kit Wireless-Sensoren SmartTub®		919405450
			€ 560
			BRUSHED GREY
			MODERN HARDWOOD
			SMOKED EBONY
	VersaStep™ • Stufe VersaStep™		890011360
			890011350
			890011370
			€ 602
	J-300™ Cover lifter manual drop-behind Manueller Lift für Wärmeabdeckung (hinter dem Whirlpool)		890011440
			€ 1.310
	J-300™ Covermate manual Abdeckungsheber J-300™ manuell		890011450
			€ 541
	J-300™ Cover lifter hydraulic assist Hydraulischer Heber für Wärmeabdeckung		890011460
			€ 757
	J-300™ Covermate manual Abdeckungsheber J-300™ manuell		890011500
			€ 865



J-335™



MADE IN ITALY Production from / Produktion ab May 2025

J-335™ LOUNGE
Design Jacuzzi®

SmartTub®

214 x 214 x 92 H cm
214 x 214 x 93 H cm Made in Italy

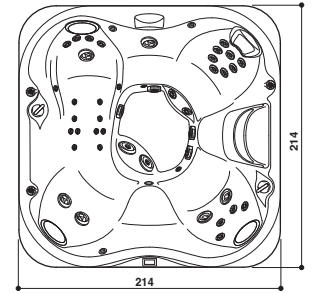

FEATURES • VERSIONEN

	Seats (total) • Sitzflächen (insgesamt)
	Lounge
	Jets • Düsen
	IR and Red Lights • Infrarotlampen und rotes Licht
	Waterfall with lights • Beleuchteter Wasserfall
	HydroSoothe™ hydromassage headrest • Hydromassage-Kopfstütze
	Soft and thin headrest • Weiche und dünne Kopfstütze
	Underwater LED multicolor light Mehrfarbige Unterwasser-LED-Leuchte
	Touch Screen Controls • Touch-Bedienelement
	External corner lighting (white LED) Außenecken-Beleuchtung (weiße LED)
	CLEARARRAY Active Oxygen® System
	CLEARARRAY® System On-demand button • auf Anfrage (mit entsprechendem Druckknopf)
	SmartTub®
	SmartTub® Three-phase upgrade kit

FREESTANDING		
5-6		
1		
42		
2		
1		
1		
3		
✓		
✓		
✓		
✓		
919405440		
€ 1.202		
919405320		
€ 380		

CONFIGURATIONS • KONFIGURATIONEN

	FINISHING
SmartTub® IR and Red Lights Bluewave™ Stereo System	Platinum
	Silver Pearl
	Midnight
	Porcelain (White)
SmartTub® IR and Red Lights Infrarotlampen und rotes Licht	Platinum
	Silver Pearl
	Midnight
	Porcelain (White)
IR and Red Lights Infrarotlampen und rotes Licht	Platinum
	Silver Pearl
	Midnight
	Porcelain (White)
Basic	Platinum
	Silver Pearl
	Midnight
	Porcelain (White)

BRUSHED GREY	MODERN HARDWOOD	SMOKED EBONY
ZP12RU0EWM0	-	ZP12RY0EWM0
ZP33RU0EWM0	-	ZP33RY0EWM0
ZP62RU0EWM0	-	ZP62RY0EWM0
ZP76RU0EWM0	-	ZP76RY0EWM0
€ 24.625	-	€ 24.625
ZC12RU0EWM0	ZC12RD0EWM0	ZC12RY0EWM0
ZC33RU0EWM0	ZC33RD0EWM0	ZC33RY0EWM0
ZC62RU0EWM0	ZC62RD0EWM0	ZC62RY0EWM0
ZC76RU0EWM0	-	ZC76RY0EWM0
€ 22.900	€ 23.508	€ 22.900
ZC12RU0EWO	-	ZC12RY0EWO
ZC33RU0EWO	-	ZC33RY0EWO
ZC62RU0EWO	-	ZC62RY0EWO
ZC76RU0EWO	-	ZC76RY0EWO
€ 22.010	-	€ 22.010
ZC12ZU0EWO	ZC12ZD0EWT	ZC12ZY0EWO
ZC33ZU0EWO	ZC33ZD0EWT	ZC33ZY0EWO
ZC62ZU0EWO	ZC62ZD0EWT	ZC62ZY0EWO
ZC76ZU0EWO	-	ZC76ZY0EWO
€ 21.260	€ 21.868	€ 21.260

INSULATING COVER to be included in the order • WÄRMEABDECKUNG Muss im Auftrag enthalten sein

	PROLAST™	Black • Schwarz
--	----------	-----------------

903002411
€ 1.395

ACCESSOIRES • ZUBEHÖRE

	SmartTub® Wireless Sensor Kit • Kit Wireless-Sensoren SmartTub®
	VersaStep™ • Stufe VersaStep™
	J-300™ Cover lifter manual drop-behind Manueller Lift für Wärmeabdeckung (hinter dem Whirlpool)
	J-300™ Covermate manual • Abdeckungsheber J-300™ manuell
	J-300™ Cover lifter hydraulic assist • Hydraulischer Heber für Wärmeabdeckung
	J-300™ Covermate manual • Abdeckungsheber J-300™ manuell

919405450		
€ 560		
BRUSHED GREY	MODERN HARDWOOD	SMOKED EBONY
890011360	890011350	890011370
€ 602		
890011440		
€ 1.310		
890011450		
€ 541		
890011460		
€ 757		
890011500		
€ 865		



J-335™ CLASSIC

Design Jacuzzi®



214 x 214 x 93 H cm Made in Italy

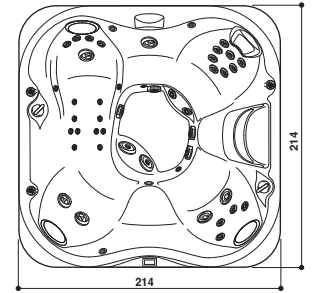

FEATURES • VERSIONEN

	Seats (total) • Sitzflächen (insgesamt)
	Lounge
	Jets • Düsen
	Waterfall with lights • Beleuchteter Wasserfall
	HydroSoothe™ hydromassage headrest • Hydromassage-Kopfstütze
	Headrest • Kopfstütze
	Underwater LED multicolor light Mehrfarbige Unterwasser-LED-Leuchte
	LED control panel • LED - Display
	External corner lighting • Außenecken-Beleuchtung
	CLEARRAY Active Oxygen® System
	CLEARRAY® System On-demand button • auf Anfrage (mit entsprechendem Druckknopf)
	SmartTub®
	SmartTub® Three-phase upgrade kit Dreiphasen-Adapter-Kit

FREESTANDING		
5-6		
1		
42		
1		
1		
3		
✓		
✓		
✓		
✓		
919405440		
€ 1.202		
919405320		
€ 380		

CONFIGURATIONS • KONFIGURATIONEN

		FINISHING • AUSFÜHRUNGEN
	SmartTub® Bluewave™ Stereo System	Platinum
		Silver Pearl
		Midnight
		Porcelain (White • Weiss)
	SmartTub®	Platinum
		Silver Pearl
		Midnight
		Porcelain (White • Weiss)
	Bluewave™ Stereo System	Platinum
		Silver Pearl
		Midnight
		Porcelain (White • Weiss)
	Basic	Platinum
		Silver Pearl
		Midnight
		Porcelain (White • Weiss)

BRUSHED GREY	MODERN HARDWOOD	SMOKED EBONY
ZP12ZU0EWM40	-	ZP12ZY0EWM40
ZP33ZU0EWM40	-	ZP33ZY0EWM40
ZP62ZU0EWM40	-	ZP62ZY0EWM40
ZP76ZU0EWM40	-	ZP76ZY0EWM40
€ 24.625	-	€ 24.625
ZC12ZU0EWM40	-	ZC12ZY0EWM40
ZC33ZU0EWM40	-	ZC33ZY0EWM40
ZC62ZU0EWM40	-	ZC62ZY0EWM40
ZC76ZU0EWM40	-	ZC76ZY0EWM40
€ 22.150	-	€ 22.150
ZP12ZU0EW40	-	ZP12ZY0EW40
ZP33ZU0EW40	-	ZP33ZY0EW40
ZP62ZU0EW40	-	ZP62ZY0EW40
ZP76ZU0EW40	-	ZP76ZY0EW40
€ 23.735	-	€ 23.735
ZC12ZU0EW40	-	ZC12ZY0EW40
ZC33ZU0EW40	-	ZC33ZY0EW40
ZC62ZU0EW40	-	ZC62ZY0EW40
ZC76ZU0EW40	-	ZC76ZY0EW40
€ 21.260	-	€ 21.260

INSULATING COVER to be included in the order • WÄRMEABDECKUNG Muss im Auftrag enthalten sein

	PROLAST™	Black • Schwarz	903002411
--	----------	-----------------	-----------

€ 1.395

ACCESSOIRES • ZUBEHÖRE

	SmartTub® Wireless Sensor Kit • Kit Wireless-Sensoren SmartTub®	919405450
	VersaStep™ • Stufe VersaStep™	€ 560
	J-300™ Cover lifter manual drop-behind Manueller Lift für Wärmeabdeckung (hinter dem Whirlpool)	890011360
	J-300™ Covermate manual Abdeckungsheber J-300™ manuell	€ 602
	J-300™ Cover lifter hydraulic assist Hydraulischer Heber für Wärmeabdeckung	890011440
	J-300™ Covermate manual Abdeckungsheber J-300™ manuell	€ 1.310
	J-300™ Cover lifter manual drop-behind Manueller Lift für Wärmeabdeckung (hinter dem Whirlpool)	890011450
	J-300™ Covermate manual Abdeckungsheber J-300™ manuell	€ 541
	J-300™ Cover lifter hydraulic assist Hydraulischer Heber für Wärmeabdeckung	890011460
	J-300™ Covermate manual Abdeckungsheber J-300™ manuell	€ 757
	J-300™ Cover lifter manual drop-behind Manueller Lift für Wärmeabdeckung (hinter dem Whirlpool)	890011500
	J-300™ Covermate manual Abdeckungsheber J-300™ manuell	€ 865

BRUSHED GREY	MODERN HARDWOOD	SMOKED EBONY
890011360	890011350	890011370
€ 602		
890011440		
€ 1.310		
890011450		
€ 541		
890011460		
€ 757		
890011500		
€ 865		



J-332™
Design Jacuzzi®

LOUNGE x2

SmartTub®

214 x 214 x 93 H cm Made in Italy

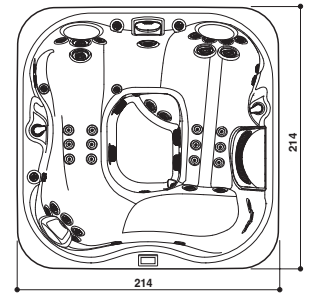

FEATURES • VERSIONEN

	Seats (total) • Sitzflächen (insgesamt)
new	Lounge
	Jets • Düsen
new	IR and Red Lights • Infrarotlampen und rotes Licht
	Waterfall with lights • Beleuchteter Wasserfall
	HydroSoothe™ hydromassage headrest • Hydromassage-Kopfstütze
new	Soft and thin headrest • Weiche und dünne Kopfstütze
	Underwater LED multicolor light Mehrfarbige Unterwasser-LED-Leuchte
new	Touch Screen Controls • Touch-Bedienelement
new	External corner lighting (white LED) Außencken-Beleuchtung (weiße LED)
	CLEARRAY Active Oxygen® System
	CLEARRAY® System On-demand button • auf Anfrage (mit entsprechendem Druckknopf)
	SmartTub®
SmartTub®	Three-phase upgrade kit

FREESTANDING		
5		
2		
46		
2		
1		
1		
3		
✓		
✓		
✓		
✓		
919405440		
€ 1.202		
919405320		
€ 380		

CONFIGURATIONS • KONFIGURATIONEN

	FINISHING
SmartTub® IR and Red Lights Bluewave™ Stereo System	Platinum
	Silver Pearl
	Midnight
	Porcelain (White)
SmartTub® IR and Red Lights Infrarotlampen und rotes Licht	Platinum
	Silver Pearl
	Midnight
	Porcelain (White)
IR and Red Lights Infrarotlampen und rotes Licht	Platinum
	Silver Pearl
	Midnight
	Porcelain (White)
Basic	Platinum
	Silver Pearl
	Midnight
	Porcelain (White)

BRUSHED GREY	MODERN HARDWOOD	SMOKED EBONY
Z812RU0EWM0	-	Z812RY0EWM0
Z833RU0EWM0	-	Z833RY0EWM0
Z862RU0EWM0	-	Z862RY0EWM0
Z876RU0EWM0	-	Z876RY0EWM0
€ 24.625	-	€ 24.625
Z712RU0EWM0	-	Z712RY0EWM0
Z733RU0EWM0	-	Z733RY0EWM0
Z762RU0EWM0	-	Z762RY0EWM0
Z776RU0EWM0	-	Z776RY0EWM0
€ 22.900	-	€ 22.900
Z712RU0EWO	-	Z712RY0EWO
Z733RU0EWO	-	Z733RY0EWO
Z762RU0EWO	-	Z762RY0EWO
Z776RU0EWO	-	Z776RY0EWO
€ 22.010	-	€ 22.010
Z712ZU0EWO	-	Z712ZY0EWO
Z733ZU0EWO	-	Z733ZY0EWO
Z762ZU0EWO	-	Z762ZY0EWO
Z776ZU0EWO	-	Z776ZY0EWO
€ 21.260	-	€ 21.260

INSULATING COVER to be included in the order • WÄRMEABDECKUNG Muss im Auftrag enthalten sein

	PROLAST™	Black • Schwarz
--	----------	-----------------

903002411
€ 1.395

ACCESSOIRES • ZUBEHÖRE

	SmartTub® Wireless Sensor Kit • Kit Wireless-Sensoren SmartTub®
	VersaStep™ • Stufe VersaStep™
	J-300™ Cover lifter manual drop-behind Manueller Lift für Wärmeabdeckung (hinter dem Whirlpool)
	J-300™ Covermate manual • Abdeckungsheber J-300™ manuell
	J-300™ Cover lifter hydraulic assist • Hydraulischer Heber für Wärmeabdeckung
	J-300™ Covermate manual • Abdeckungsheber J-300™ manuell

919405450		
€ 560		
BRUSHED GREY	MODERN HARDWOOD	SMOKED EBONY
890011360	890011350	890011370
€ 602		
890011440		
€ 1.310		
890011450		
€ 541		
890011460		
€ 757		
890011500		
€ 865		

new



J-332™



J-325™

Design Jacuzzi®



193 x 214 x 85 H cm

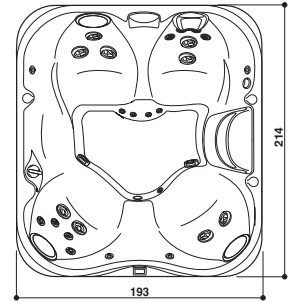

FEATURES • VERSIONEN

		FREESTANDING
	Seats (total) • Sitzflächen (insgesamt)	4-5
	Lounge	--
	Jets • Düsen	23
	Waterfall with lights • Beleuchteter Wasserfall	✓
	HydroSoothe™ hydromassage headrest • Hydromassage-Kopfstütze	1
new	Soft and thin headrest • Weiche und dünne Kopfstütze	3
	Underwater LED multicolor light Mehrfarbige Unterwasser-LED-Leuchte	✓
new	Touch Screen Controls • Touch-Bedienelement	✓
new	External corner lighting (white LED) Außenecken-Beleuchtung (weiße LED)	✓
	CLEARRAY Active Oxygen® System	✓
	CLEARRAY® System On-demand button • auf Anfrage (mit entsprechendem Druckknopf)	✓

CONFIGURATIONS • KONFIGURATIONEN		FINISHING • AUSFÜHRUNGEN	BRUSHED GREY	MODERN HARDWOOD	SMOKED EBONY
	SmartTub®	Platinum	ZB12ZU0EWMT	ZB12ZD0EWMT	ZB12ZY0EWMT
		Silver Pearl	ZB33ZU0EWMT	ZB33ZD0EWMT	ZB33ZY0EWMT
		Midnight	ZB62ZU0EWMT	ZB62ZD0EWMT	ZB62ZY0EWMT
			€ 20.988		
	Basic	Platinum	ZB12ZU0EWT	ZB12ZD0EWT	ZB12ZY0EWT
		Silver Pearl	ZB33ZU0EWT	ZB33ZD0EWT	ZB33ZY0EWT
		Midnight	ZB62ZU0EWT	ZB62ZD0EWT	ZB62ZY0EWT
			€ 20.098		

Bluewave™ Stereo System on request - contact the office • auf Anfrage - kontaktieren Sie die Büros

INSULATING COVER to be included in the order • WÄRMEABDECKUNG Muss im Auftrag enthalten sein

	PROLAST™	Black • Schwarz	903003590
			€ 1.328

ACCESSOIRES • ZUBEHÖRE

	Three-phase upgrade kit • Dreiphasen-Adapter-Kit	919405320
		€ 380
	SmartTub® Wireless Sensor Kit • Kit Wireless-Sensoren SmartTub®	919405450
		€ 560
	VersaStep™ • Stufe VersaStep™	890011360
		€ 602
	Cover lifter manual drop-behind Manueller Lift für Wärmeabdeckung (hinter dem Whirlpool)	890011440
		€ 1.310
	J-300™ Covermate manual Abdeckungsheber J-300™ manuell	890011450
		€ 541
	J-300™ Cover lifter hydraulic assist Hydraulischer Heber für Wärmeabdeckung	890011460
		€ 757
	J-300™ Covermate manual Abdeckungsheber J-300™ manuell	890011500
		€ 865



J-315™



MADE IN ITALY

Production from / Produktion ab July 2025

J-315™
Design Jacuzzi®



193 x 168 x 81 H cm

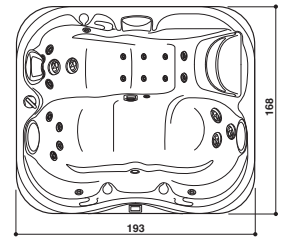

FEATURES • VERSIONEN

		FREESTANDING
	Seats (total) • Sitzflächen (insgesamt)	2-3
	Lounge	1
	Jets • Düsen	23
	Waterfall with lights • Beleuchteter Wasserfall	✓
	HydroSoothe™ hydromassage headrest • Hydromassage-Kopfstütze	1
new	Soft and thin headrest • Weiche und dünne Kopfstütze	2
	Underwater LED multicolor light Mehrfarbige Unterwasser-LED-Leuchte	✓
new	Touch Screen Controls • Touch-Bedienelement	✓
new	External corner lighting (white LED) Außenecken-Beleuchtung (weiße LED)	✓
	CLEARRAY Active Oxygen® System	✓
	CLEARRAY® System On-demand button • auf Anfrage (mit entsprechendem Druckknopf)	✓

CONFIGURATIONS • KONFIGURATIONEN		FINISHING • AUSFÜHRUNGEN	BRUSHED GREY	MODERN HARDWOOD	SMOKED EBONY
	SmartTub®	Platinum	ZA12ZU0EWM0	ZA12ZD0EWM0	ZA12ZY0EWM0
		Silver Pearl	ZA33ZU0EWM0	ZA33ZD0EWM0	ZA33ZY0EWM0
		Midnight	ZA62ZU0EWM0	ZA62ZD0EWM0	ZA62ZY0EWM0
		Porcelain (Bianco)	ZA76ZU0EWM0	-	ZA76ZY0EWM0
			€ 18.017		
	Basic	Platinum	ZA12ZU0EWO	ZA12ZD0EWO	ZA12ZY0EWO
		Silver Pearl	ZA33ZU0EWO	ZA33ZD0EWO	ZA33ZY0EWO
		Midnight	ZA62ZU0EWO	ZA62ZD0EWO	ZA62ZY0EWO
		Porcelain (Bianco)	ZA76ZU0EWO	-	ZA76ZY0EWO
			€ 17.127		

Bluewave™ Stereo System on request - contact the office • auf Anfrage - kontaktieren Sie die Büros

INSULATING COVER to be included in the order • WÄRMEABDECKUNG Muss im Auftrag enthalten sein

	PROLAST™	Black • Schwarz	903003611
			€ 1.203

ACCESSOIRES • ZUBEHÖRE

	Three-phase upgrade kit • Dreiphasen-Adapter-Kit	919405320
		€ 380
	SmartTub® Wireless Sensor Kit • Kit Wireless-Sensoren SmartTub®	919405450
		€ 560
	VersaStep™ • Stufe VersaStep™	890011360
		€ 602
	Cover lifter manual drop-behind Manueller Lift für Wärmeabdeckung (hinter dem Whirlpool)	890011440
		€ 1.310
	J-300™ Covermate manual Abdeckungsheber J-300™ manuell	890011450
		€ 541
	J-300™ Cover lifter hydraulic assist Hydraulischer Heber für Wärmeabdeckung	890011460
		€ 757
	J-300™ Covermate manual Abdeckungsheber J-300™ manuell	890011500
		€ 865



J-315™
Design Jacuzzi®



193 x 168 x 81 H cm

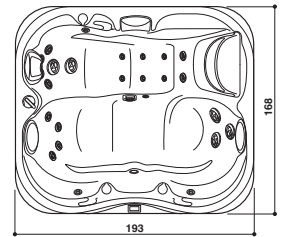

FEATURES • VERSIONEN

		FREESTANDING
	Seats (total) • Sitzflächen (insgesamt)	2-3
	Lounge	1
	Jets • Düsen	23
	Waterfall with lights • Beleuchteter Wasserfall	✓
	HydroSoothe™ hydromassage headrest • Hydromassage-Kopfstütze	1
new	Soft and thin headrest • Weiche und dünne Kopfstütze	2
	Underwater LED multicolor light Mehrfarbige Unterwasser-LED-Leuchte	✓
new	Touch Screen Controls • Touch-Bedienelement	✓
new	External corner lighting (white LED) Außenecken-Beleuchtung (weiße LED)	✓
	CLEARARRAY Active Oxygen® System	✓
	CLEARARRAY® System On-demand button • auf Anfrage (mit entsprechendem Druckknopf)	✓

CONFIGURATIONS • KONFIGURATIONEN		FINISHING • AUSFÜHRUNGEN	BRUSHED GREY	MODERN HARDWOOD	SMOKED EBONY
	SmartTub®	Platinum	ZA12ZU0EWMT	ZA12ZD0EWMT	ZA12ZY0EWMT
		Silver Pearl	ZA33ZU0EWMT	ZA33ZD0EWMT	ZA33ZY0EWMT
		Midnight	ZA62ZU0EWMT	ZA62ZD0EWMT	ZA62ZY0EWMT
			€ 18.017		
	Basic	Platinum	ZA12ZU0EWT	ZA12ZD0EWT	ZA12ZY0EWT
		Silver Pearl	ZA33ZU0EWT	ZA33ZD0EWT	ZA33ZY0EWT
		Midnight	ZA62ZU0EWT	ZA62ZD0EWT	ZA62ZY0EWT
			€ 17.127		

Bluewave™ Stereo System on request - contact the office • auf Anfrage - kontaktieren Sie die Büros

INSULATING COVER to be included in the order • WÄRMEABDECKUNG Muss im Auftrag enthalten sein

	PROLAST™	Black • Schwarz	903003611
			€ 1.203

ACCESSOIRES • ZUBEHÖRE

	Three-phase upgrade kit • Dreiphasen-Adapter-Kit	919405320
		€ 380
	SmartTub® Wireless Sensor Kit • Kit Wireless-Sensoren SmartTub®	919405450
		€ 560
	VersaStep™ • Stufe VersaStep™	890011360
		€ 602
	Cover lifter manual drop-behind Manueller Lift für Wärmeabdeckung (hinter dem Whirlpool)	890011440
		€ 1.310
	J-300™ Covermate manual Abdeckungsheber J-300™ manuell	890011450
		€ 541
	J-300™ Cover lifter hydraulic assist Hydraulischer Heber für Wärmeabdeckung	890011460
		€ 757
	J-300™ Covermate manual Abdeckungsheber J-300™ manuell	890011500
		€ 865

Jacuzzi®



J-200™ Classic



MADE IN ITALY

J-235™ CLASSIC

Design Jacuzzi®



213 x 213 x 91 H cm

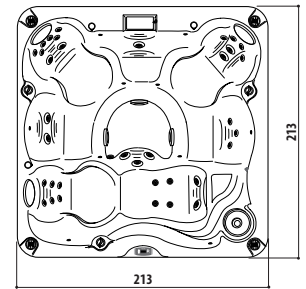

FEATURES • VERSIONEN

		FREESTANDING	
	Seats (total) Sitzflächen (insgesamt)	6	
	Lounge seat Lounge Sitzfläche	1	
	Jets Düsen	35	
	Underwater LED multicolor light Mehrfarbige Unterwasser-LED-Leuchte	6	
	Waterfall Wasserfall	✓	
	CLEARRAY Active Oxygen® System	✓	
	Headrest Kopfstütze	3	
	LED control panel LED - Display	✓	
	EcoShield insulation Eco Shield-Isolierung	✓	--
	Nordic insulation (Modular Sealed Foam + Smart Seal) Nordische Isolierung (Modular Sealed Foam + Smart Seal)	--	✓
	ProLast™ Cover Wärmeabdeckung ProLast™	Black • Schwarz	

CONFIGURATIONS • KONFIGURATIONEN

		FINISHING AUSFÜHRUNGEN	
		SILVERWOOD	
	Without Stereo System Ohne Stereo System	Platinum	
		Z112ZG0E80	Z112ZG0EW0

NOTE: Porcelain (White • Weiss), Silver Pearl, Midnight finishes on request. • **HINWEIS:** Auf Wunsch mit Oberflächenausführung Porcelain (White • Weiss), Silver Pearl, Midnight

€ 12.306

€ 12.843

INSULATING COVER to be included in the order • WÄRMEABDECKUNG Muss im Auftrag enthalten sein

	PROLAST™	Black • Schwarz	903003211
			€ 1.110

ACCESSOIRES • ZUBEHÖRE

	Smart step Stufe Smart step	Black • Schwarz	890011600
			€ 526
	Cover lifter manual drop-behind Manueller Lift für Wärmeabdeckung (hinter dem Whirlpool)		890011440
			€ 1.310
	Cover lifter manual Manueller Lift für Wärmeabdeckung		890011450
			€ 541
	Cover lifter hydraulic assist Hydraulischer Heber für Wärmeabdeckung		890011460
			€ 757
	Cover lifter undermount manual Manueller Lift für Wärmeabdeckung		890011500
			€ 865

A high-angle photograph of a wooden deck. In the upper left, a portion of a brown patio umbrella is visible. Below it, a curved wooden bench made of slats is positioned. The deck is made of light-colored wooden planks. A large, dark shadow of a palm tree is cast across the deck from the right side. In the bottom left corner, there is a blurred green plant.

Jacuzzi®

DESIGN





INSTRUCTIONS FOR ORDERING

Dimensions and descriptions are indicated in the master brochure and in this price list.

Orders must include:

- a) name **VIRTUS**
- b) spa code **VIRQ1023354**
- c) cover code **903002472**

NOTE: Optional and accessories marked with dedicated codes to be ordered separately are not included or installed on the product.

HINWEISE ZUR BESTELLUNG

Zur Beschreibung und für die Abmessungen, sollte man sich auf den Katalog und die Preisliste beziehen.

Die Bestellungen sollten folgendes beinhalten:

- a) Name **VIRTUS**
- b) Artikel-Nr. **VIRQ1023354**
- c) Wärmeabdeckung-Nr. **903002472**

NOTE: Optional und accessoires, die mit entsprechenden Codes gekennzeichnet sind, die separat bestellt werden müssen, sind nicht im Produkt inbegriffen oder installiert.



DO NOT USE SEA WATER OR WATER WITH ADDED SALT ON ALL HOT TUB AND SWIM SPA MODELS.

ALLE HOT TUB- UND SWIM SPA-MODELLE NICHT MIT MEERWASSER ODER MIT ZUGESETZTEM SALZ VERWENDEN.



VIRTUS

Design Dodo Arslan & Jacuzzi® Design



250 x 215 x 93 H cm

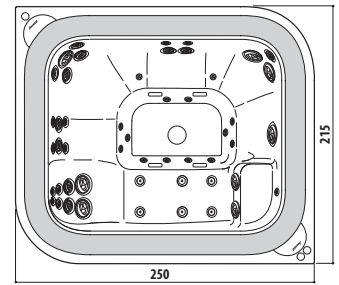

FEATURES • VERSIONEN

	Sièges (total) Sitzflächen (insgesamt)	6-7
	Lounge	1
	Jets Düsen	50
	Underwater LED multicolor light Mehrfarbige Unterwasser-LED-Leuchte	2
	LCD operator control panel + User controls LCD-Bediener-Bedienfeld + Benutzerkontrollen	✓
	Smart Access Door "Smart Access" Panel	✓
	Automatic water fill-up Automatische Wasserfüllung	✓
	Quick drain System Schnelle Entleerung System	✓
	Snap-on cartridge filter with filter surface area of 9,29 m ² . Kartuschen-Druckfilter mit einer Filterfläche von 9 m ² .	✓
	CLEARRAY Active Oxygen® System	✓
	Eco shield insulation Eco Shield-Isolierung	○

NOTE: WATER CONNECTION AND DRAIN REQUIRED
HINWEIS: WASSER- UND ABWASSERANSCHLUSS ERFORDERLICH

		BUILT-IN	FREESTANDING		
CONFIGURATIONS • KONFIGURATIONEN			TEAK	GRAPHITE	
	3 kW electric heater 3 kW elektrische heizung	Platinum	VIRA1223050	VIRA1223353	VIRA1223354
		Porcelain (White • Weiss)	VIRA7623050	VIRA7623353	VIRA7623354
			€ 23.184	€ 28.286	
	Heat exchanger Wärmetauscher	Platinum	VIRA1221050	VIRA1221353	VIRA1221354
		Porcelain (White • Weiss)	VIRA7621050	VIRA7621353	VIRA7621354
			€ 23.830	€ 28.931	

INSULATING COVER to be included in the order • WÄRMEABDECKUNG Muss im Auftrag enthalten sein

	Insulating cover in two folding parts Zweiteilige klappbare Thermoabdeckung	ProVinyl - Ice	903002472
			€ 2.090

NOTE: Cover lifter not available • **HINWEIS:** Heber für Thermoabdeckung nicht verfügbar

ACCESSOIRES • ZUBEHÖRE

AISI 316 L frame • Rahmen aus AISI 316 L	on request • auf Anfrage
	+ € 1.000



PROFILE

Design Jacuzzi®



235 x 211 x 93 H cm

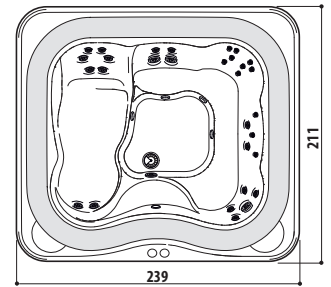

FEATURES • VERSIONEN

	Seats (total) Sitzflächen (insgesamt)	5-6
	Lounge	1
	Jets Düsen	31
	Underwater LED multicolor light Mehrfarbige Unterwasser-LED-Leuchte	✓
	Automatic water fill-up Automatische Wasserfüllung	✓
	LCD operator control panel + User controls LCD-Bediener-Bedienfeld + Benutzerkontrollen	✓
	Quick drain System Schnelle Entleerung System	✓
	Snap-on cartridge filter with filter surface area of 9,29 m ² . Kartuschen-Druckfilter mit einer Filterfläche von 9 m ² .	✓
	CLEARRAY® UV-C System	✓

NOTE: WATER CONNECTION AND DRAIN REQUIRED
HINWEIS: WASSER- UND ABWASSERANSCHLUSS ERFORDERLICH

		BUILT-IN	FREESTANDING
CONFIGURATIONS • KONFIGURATIONEN	FINISHING AUSFÜHRUNGEN	--	GRAPHITE
	3 kW electric heater 3 kW elektrische Heizung	PFLA1223050	PFLA1223054
		PFLA7623050	PFLA7623054
		€ 19.825	€ 23.277

INSULATING COVER to be included in the order • WÄRMEABDECKUNG Muss im Auftrag enthalten sein

	PROVINYL	Ice	903002202
			€ 1.257

NOTE: Cover lifter not available • **HINWEIS:** Heber für Thermoabdeckung nicht verfügbar

ACCESSOIRES • ZUBEHÖRE

	Winter Pro Kit	943613030
		€ 1.099
AISI 316 L frame • Rahmen aus AISI 316 L		on request • auf Anfrage
		+ € 1.000



SANTORINI

Design Kaluderovic & Condini



230 x 215 x 90 H cm

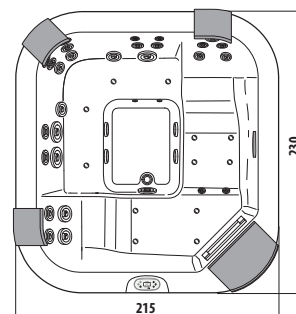

FEATURES • VERSIONEN

	Seats (total) Sitzflächen (insgesamt)	5
	Lounge	2
	Jets Düsen	29
	Blowers	14
	Underwater LED multicolor light Mehrfarbige Unterwasser-LED-Leuchte	✓
	Cascade Wasserfall	✓
	Removable headrests and cushion Abnehmbare Kopfstütze und Kissen	4
	LCD control panel LCD - Display	✓
	CLEARRAY® UV-C System	✓

		BUILT-IN	FREESTANDING		
CONFIGURATIONS • KONFIGURATIONEN		FINISHING AUSFÜHRUNGEN	TEAK	GRAPHITE	
	3 kW electric heater 3 kW elektrische Heizung	Platinum	SNTA1233010	SNTA1233013	SNTA1233014
		Porcelain (White • Weiss)	SNTA7633010	SNTA7633013	SNTA7633014
			€ 22.787	€ 26.644	
	Heat exchanger Wärmetauscher	Platinum	SNTA1231010	SNTA1231013	SNTA1231014
		Porcelain (White • Weiss)	SNTA7631010	SNTA7631013	SNTA7631014
			€ 23.664	€ 27.404	

INSULATING COVER to be included in the order • WÄRMEABDECKUNG Muss im Auftrag enthalten sein

	PROVINYL	Ice	903001482
			€ 1.367

NOTE: Cover lifter not available • **HINWEIS:** Heber für Thermoabdeckung nicht verfügbar

ACCESSOIRES • ZUBEHÖRE

	Winter Pro Kit	943613050
		€ 1.099
	Performance Kit · Sand not included Sand ist nicht inklusive	94428200
		€ 1.808
	1 x 25 kg bag of sand 1 Sack Sand 25 kg	23320507
		€ 49
AISI 316 L frame • Rahmen aus AISI 316 L		on request • auf Anfrage
		+ € 1.000



DELOS

Design Kaluderovic & Condini



215 x 190 x 80 H cm

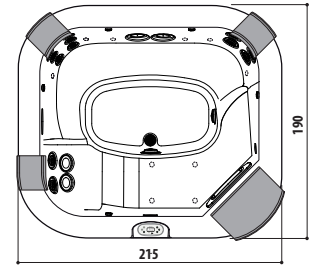

FEATURES • VERSIONEN

	Seats (total) Sitzflächen (insgesamt)	4
	Lounge	1
	Jets Düsen	16
	Blowers	10
	Underwater LED multicolor light Mehrfarbige Unterwasser-LED-Leuchte	✓
	Cascade Wasserfall	✓
	Removable headrests and cushion Abnehmbare Kopfstütze und Kissen	4
	LCD control panel LCD - Display	✓
	CLEARRAY® UV-C System	✓

		BUILT-IN	FREESTANDING		
CONFIGURATIONS • KONFIGURATIONEN		FINISHING AUSFÜHRUNGEN	TEAK	GRAPHITE	
	3 kW electric heater 3 kW elektrische Heizung	Platinum	DLSA1233010	DLSA1233013	DLSA1233014
		Porcelain (White • Weiss)	DLSA7633010	DLSA7633013	DLSA7633014
			€ 18.989	€ 22.087	
	Heat exchanger Wärmetauscher	Platinum	DLSA1231010	DLSA1231013	DLSA1231014
		Porcelain (White • Weiss)	DLSA7631010	DLSA7631013	DLSA7631014
			€ 19.866	€ 22.905	

INSULATING COVER to be included in the order • WÄRMEABDECKUNG Muss im Auftrag enthalten sein

	ProVinyl	Ice	903001542
			€ 1.129

NOTE: Cover lifter not available • **HINWEIS:** Heber für Thermoabdeckung nicht verfügbar

ACCESSOIRES • ZUBEHÖRE

	Winter Pro Kit	943613060
		€ 1.099
	Performance Kit · Sand not included Sand ist nicht inklusive	94428200
		€ 1.808
	1 x 25 kg bag of sand 1 Sack Sand 25 kg	23320507
		€ 49
AISI 316 L frame • Rahmen aus AISI 316 L		on request • auf Anfrage
		+ € 1.000



DELFI

Design Kaluderovic & Condini



190 x 190 x 80 H cm

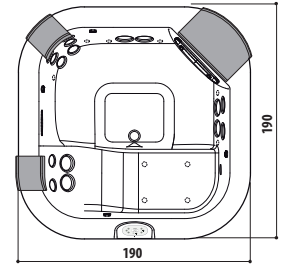

FEATURES • VERSIONEN

	Seats (total) Sitzflächen (insgesamt)	4
	Lounge	1
	Jets Düsen	16
	Blowers	10
	Underwater LED multicolor light Mehrfarbige Unterwasser-LED-Leuchte	✓
	Cascade Wasserfall	✓
	Removable headrests and cushion Abnehmbare Kopfstütze und Kissen	3
 	LCD control panel LCD - Display	✓
	CLEARRAY® UV-C System	✓

		BUILT-IN	FREESTANDING		
CONFIGURATIONS • KONFIGURATIONEN		FINISHING AUSFÜHRUNGEN	TEAK	GRAPHITE	
	3 kW electric heater 3 kW elektrische Heizung	Platinum	DLFA1233010	DLFA1233013	DLFA1233014
		Porcelain (White • Weiss)	DLFA7633010	DLFA7633013	DLFA7633014
			€ 17.938	€ 20.918	

INSULATING COVER to be included in the order • WÄRMEABDECKUNG Muss im Auftrag enthalten sein

	ProVinyl	Ice	903001562
			€ 1.063

NOTE: Cover lifter not available • **HINWEIS:** Heber für Thermoabdeckung nicht verfügbar

ACCESSOIRES • ZUBEHÖRE

	Winter Pro Kit	943613070
		€ 1.099
	Performance Kit · Sand not included Sand ist nicht inklusive	94428200
		€ 1.808
	1 x 25 kg bag of sand 1 Sack Sand 25 kg	23320507
		€ 49
AISI 316 L frame • Rahmen aus AISI 316 L		on request • auf Anfrage
		+ € 1.000



UNIQUE

Design Carlo Urbinati



190 x 150 x 80 H cm

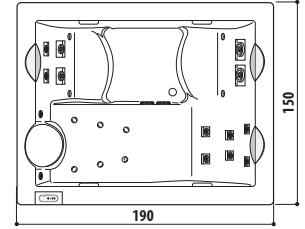

FEATURES • VERSIONEN

	Seats (total) Sitzflächen (insgesamt)	3
	Lounge	1
	Jets Düsen	14
	Blowers	10
	Underwater LED multicolor light Mehrfarbige Unterwasser-LED-Leuchte	✓
	Headrests Kopfstütze	3
	LCD control panel LCD - Display	✓
	CLEARRAY® UV-C System	✓

		BUILT-IN	FREESTANDING	
CONFIGURATIONS • KONFIGURATIONEN	FINISHING AUSFÜHRUNGEN	--	WHITE OAK	GREY OAK
	3 kW electric heater 3 kW elektrische Heizung	Platinum	UNQA1233010	UNQA1233019
		Porcelain (White • Weiss)	UNQA7633010	UNQA7633019
		€ 14.549	€ 17.178	

INSULATING COVER to be included in the order • WÄRMEABDECKUNG Muss im Auftrag enthalten sein

	ProVinyl	Ice	903001682
			€ 919

NOTE: Cover lifter not available • **HINWEIS:** Heber für Thermoabdeckung nicht verfügbar

ACCESSOIRES • ZUBEHÖRE

	Winter Pro Kit	943613040
		€ 1.099
	Performance Kit · Sand not included Sand ist nicht inklusive	94428200
		€ 1.808
	1 x 25 kg bag of sand 1 Sack Sand 25 kg	23320507
		€ 49
AISI 316 L frame • Rahmen aus AISI 316 L		on request • auf Anfrage
		+ € 1.000



CITY™ SPA

Design Kaluderovic & Condini

LOUNGE x2

MADE IN ITALY

150 x 160 x 75 H cm

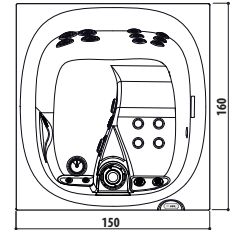

FEATURES • VERSIONEN

	Seats (total) Sedute (totali)	2
	Lounge	2
	Jets Düsen	20
	Underwater LED multicolor light Mehrfarbige Unterwasser-LED-Leuchte	✓
	LCD control panel LCD - Display	✓
	CLEARRAY® UV-C System	✓

		BUILT-IN	FREESTANDING	
CONFIGURATIONS • KONFIGURATIONEN	FINISHING AUSFÜHRUNGEN	--	WHITE OAK	GREY OAK
	3 kW electric heater 3 kW elektrische Heizung	Platinum	CTYA1223018	CTYA1223019
		Porcelain (White • Weiss)	CTYA7623018	CTYA7623019
		€ 12.738	€ 14.023	

INSULATING COVER to be included in the order • WÄRMEABDECKUNG Muss im Auftrag enthalten sein

	ProVinyl	Ice	903001732
			€ 851

NOTE: Cover lifter not available • **HINWEIS:** Heber für Thermoabdeckung nicht verfügbar

ACCESSOIRES • ZUBEHÖRE

	Winter Pro Kit	943613080
		€ 806
AISI 316 L frame • Rahmen aus AISI 316 L		on request • auf Anfrage
		+ € 1.000



ALIMIA

Design Jacuzzi®



Ø 212 x 90 H cm

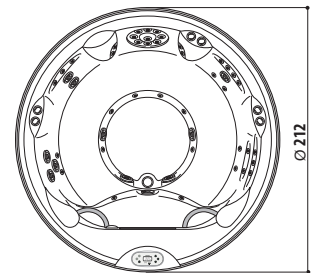

FEATURES • VERSIONEN

	Seats (total) Sitzflächen (insgesamt)	5-6
	Jets Düsen	28
	Blowers	12
	Light System - Multicolour	✓
new	LCD control panel LCD - Display	✓
	CLEARRAY® UV-C System	✓

		BUILT-IN	FREESTANDING
CONFIGURATIONS • KONFIGURATIONEN		--	GRAPHITE
	3 kW electric heater 3 kW elektrische Heizung	ALMA1233010	ALMA1233014
		ALMA7633010	ALMA7633014
		€ 21.401	€ 25.101

INSULATING COVER to be included in the order • WÄRMEABDECKUNG Muss im Auftrag enthalten sein

	ProVinyl	Ice	903001672
			€ 1.137

NOTE: Cover lifter not available • **HINWEIS:** Heber für Thermoabdeckung nicht verfügbar

ACCESSOIRES • ZUBEHÖRE

	Winter Pro Kit	943613260
		€ 1.099
AISI 316 L frame • Rahmen aus AISI 316 L		on request • auf Anfrage
		+ € 1.000















UNIQUE

Jacuzzi®

LODGE+





FEATURES • VERSIONEN		LODGE+ S	LODGE+ M	LODGE+ L
	Dimensions Abmessungen	185 x 165 x 90H cm	200 x 185 x 90H cm	211 x 223 x 90H cm
	Seats (total) Sitzflächen (insgesamt)	2-3	4-5	5-6
	Lounge	1	--	1
	Jets Düsen	16	20	24
	Blowers	10	12	14
	Underwater LED multicolor light Mehrfarbige Unterwasser-LED-Leuchte		✓	
	LCD operator control panel + User controls LCD-Bediener-Bedienfeld + Benutzerkontrollen		✓	
	CLEARRAY® UV-C System		✓	
	Eco shield insulation Eco Shield-Isolierung		○	
	Skirting Paneele	SILVERWOOD • ROASTED CHESTNUT		
	Electric heater (3 kW) and circulation pump Elektrisches Heizgerät (3 kW) und Umwälzpumpe		○	
	Heat exchanger Wärmetauscher		○	
	Quick drain® / Quick drain System Quick drain® / Schnelle Entleerung		✓	

✓ Standard ○ Depending on the version

NOTE: Do not use sea water or water with added salt on all Hot Tub and Swim Spa models.

✓ Serienmäßig ○ Seriennässig je nach gewählter Ausführung

HINWEIS: Alle Hot Tub- und Swim Spa-Modelle nicht mit Meerwasser oder mit zugesetztem Salz verwenden.



LODGE+ L

Design Jacuzzi®

211 x 223 x 90 H cm



Drawing shows the HYDRO version
Bild zeigt die HYDRO-Version

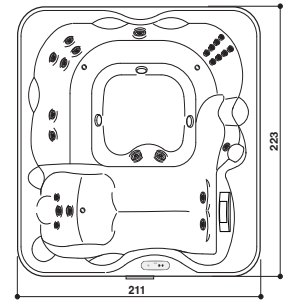

HYDRO				
		BUILT-IN	FREESTANDING	
INSULATION • ISOLIERUNG		--	ECO SHIELD	
CONFIGURATIONS • KONFIGURATIONEN		FINISHING AUSFÜHRUNGEN	SILVERWOOD	ROASTED CHESTNUT
Electric heater 3 kW Elektrisches Heizgerät 3 kW	Platinum	LDLA1223010	LDLA1223311	LDLA1223312
	Porcelain (White • Weiss)	LDLA7623010	LDLA7623311	LDLA7623312
		€ 9.996	€ 12.428	
Heat exchanger Wärmetauscher	Platinum	LDLA1221010	LDLA1221311	LDLA1221312
	Porcelain (White • Weiss)	LDLA7621010	LDLA7621311	LDLA7621312
		€ 10.204	€ 12.635	

HYDRO + BLOWER				
		BUILT-IN	FREESTANDING	
INSULATION • ISOLIERUNG		--	ECO SHIELD	
CONFIGURATIONS • KONFIGURATIONEN		FINISHING AUSFÜHRUNGEN	SILVERWOOD	ROASTED CHESTNUT
Electric heater 3 kW Elektrisches Heizgerät 3 kW	Platinum	LDLA1233010	LDLA1233311	LDLA1233312
	Porcelain (White • Weiss)	LDLA7633010	LDLA7633311	LDLA7633312
		€ 10.726	€ 13.157	
Heat exchanger Wärmetauscher	Platinum	LDLA1231010	LDLA1231311	LDLA1231312
	Porcelain (White • Weiss)	LDLA7631010	LDLA7631311	LDLA7631312
		€ 10.933	€ 13.363	

INSULATING COVER to be included in the order • WÄRMEABDECKUNG Muss im Auftrag enthalten sein				
ProVinyl	Grey • Grau	903001972		
		€ 1.286		

ACCESSOIRES • ZUBEHÖRE				
Performance Kit · Sand not included Sand ist nicht inklusive	94428200			
	€ 1.808			
1 x 25 kg bag of sand 1 Sack Sand 25 kg	23320507			
	€ 49			
Cover lifter undermount manual Manueller Lift für Wärmeabdeckung	890011500			
	€ 865			
Smart Step - 2 steps Smart Step - zweistufig	Black Schwarz	890011600		
		€ 526		
AISI 316 L frame • Rahmen aus AISI 316 L		on request • auf Anfrage		
		+ € 1.000		



LODGE+ M

Design Jacuzzi®
200 x 185 x 90 H cm



Drawing shows the HYDRO version
Bild zeigt die HYDRO-Version

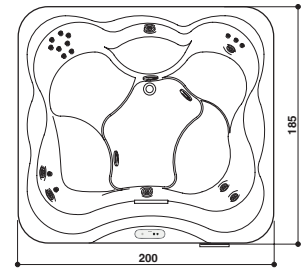

HYDRO				
		BUILT-IN	FREESTANDING	
INSULATION • ISOLIERUNG		--	ECO SHIELD	
CONFIGURATIONS • KONFIGURATIONEN		FINISHING AUSFÜHRUNGEN	SILVERWOOD	ROASTED CHESTNUT
Electric heater 3 kW Elektrisches Heizgerät 3 kW	Platinum	LDMA1223010	LDMA1223311	LDMA1223312
	Porcelain (White • Weiss)	LDMA7623010	LDMA7623311	LDMA7623312
		€ 9.212	€ 11.642	
Heat exchanger Wärmetauscher	Platinum	LDMA1221010	LDMA1221311	LDMA1221312
	Porcelain (White • Weiss)	LDMA7621010	LDMA7621311	LDMA7621312
		€ 9.419	€ 11.848	

HYDRO + BLOWER				
		BUILT-IN	FREESTANDING	
INSULATION • ISOLIERUNG		--	ECO SHIELD	
CONFIGURATIONS • KONFIGURATIONEN		FINISHING AUSFÜHRUNGEN	SILVERWOOD	ROASTED CHESTNUT
Electric heater 3 kW Elektrisches Heizgerät 3 kW	Platinum	LDMA1233010	LDMA1233311	LDMA1233312
	Porcelain (White • Weiss)	LDMA7633010	LDMA7633311	LDMA7633312
		€ 9.869	€ 12.299	
Heat exchanger Wärmetauscher	Platinum	LDMA1231010	LDMA1231311	LDMA1231312
	Porcelain (White • Weiss)	LDMA7631010	LDMA7631311	LDMA7631312
		€ 10.075	€ 12.506	

INSULATING COVER to be included in the order • WÄRMEABDECKUNG Muss im Auftrag enthalten sein				
ProVinyl	Grey • Grau	903001902		
		€ 1.141		

ACCESSOIRES • ZUBEHÖRE				
Performance Kit · Sand not included Sand ist nicht inklusive	94428200			
	€ 1.808			
1 x 25 kg bag of sand 1 Sack Sand 25 kg	23320507			
	€ 49			
Cover lifter undermount manual Manueller Lift für Wärmeabdeckung	890011500			
	€ 865			
Smart Step - 2 steps Smart Step - zweistufig	Black Schwarz	890011600		
		€ 526		
AISI 316 L frame • Rahmen aus AISI 316 L		on request • auf Anfrage		
		+ € 1.000		



LODGE+ S

Design Jacuzzi®
185 x 165 x 90 H cm



Drawing shows the HYDRO version
Bild zeigt die HYDRO-Version

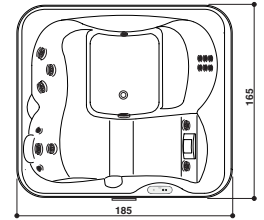

HYDRO				
		BUILT-IN	FREESTANDING	
INSULATION • ISOLIERUNG		--	ECO SHIELD	
CONFIGURATIONS • KONFIGURATIONEN		FINISHING AUSFÜHRUNGEN	SILVERWOOD	ROASTED CHESTNUT
Electric heater 3 kW Elektrisches Heizgerät 3 kW	Platinum	LDSA1223010	LDSA1223311	LDSA1223312
	Porcelain (White • Weiss)	LDSA7623010	LDSA7623311	LDSA7623312
		€ 8.405	€ 10.472	
Heat exchanger Wärmetauscher	Platinum	LDSA1221010	LDSA1221311	LDSA1221312
	Porcelain (White • Weiss)	LDSA7621010	LDSA7621311	LDSA7621312
		€ 8.611	€ 10.676	

HYDRO + BLOWER				
		BUILT-IN	FREESTANDING	
INSULATION • ISOLIERUNG		--	ECO SHIELD	
CONFIGURATIONS • KONFIGURATIONEN		FINISHING AUSFÜHRUNGEN	SILVERWOOD	ROASTED CHESTNUT
Electric heater 3 kW Elektrisches Heizgerät 3 kW	Platinum	LDSA1233010	LDSA1233311	LDSA1233312
	Porcelain (White • Weiss)	LDSA7633010	LDSA7633311	LDSA7633312
		€ 9.036	€ 11.103	
Heat exchanger Wärmetauscher	Platinum	LDSA1231010	LDSA1231311	LDSA1231312
	Porcelain (White • Weiss)	LDSA7631010	LDSA7631311	LDSA7631312
		€ 9.243	€ 11.310	

INSULATING COVER to be included in the order • WÄRMEABDECKUNG Muss im Auftrag enthalten sein				
ProVinyl	Grey • Grau	903001982		
		€ 911		

ACCESSOIRES • ZUBEHÖRE				
Performance Kit · Sand not included Sand ist nicht inklusive	94428200			
	€ 1.808			
1 x 25 kg bag of sand 1 Sack Sand 25 kg	23320507			
	€ 49			
Cover lifter undermount manual Manueller Lift für Wärmeabdeckung	890011500			
	€ 865			
Smart Step - 2 steps Smart Step - zweistufig	Black Schwarz	890011600		
		€ 526		
AISI 316 L frame • Rahmen aus AISI 316 L		on request • auf Anfrage		
		+ € 1.000		

Jacuzzi®



PROFFES

A photograph of a white hot tub on a stone patio. The hot tub is in the foreground, filled with blue water. To its right is a patterned outdoor sofa. In the background, there is a sandy beach and the ocean under a clear sky. A wooden post is visible on the right side of the frame. Two white ceramic containers with handles are on the patio near the hot tub.

PROFESSIONAL COLLECTION

SIONAL



VIRTUS PRO

Design Dodo Arslan & Jacuzzi® Design



250 x 215 x 93 H cm

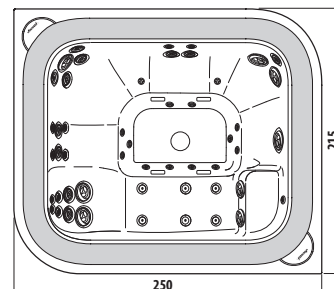

FEATURES • VERSIONEN

FEATURES • VERSIONEN		BUILT-IN
	Seats • Sitzflächen	6-7
	Lounge	1
	Jets • Düsen	50
	Underwater LED multicolor light • Mehrfarbige Unterwasser-LED-Leuchte	2
	Automatic water fill-up • Automatische Wasserbefüllung	✓
	Quick drain System • Schnelle Entleerung System	✓
	Without standard compensation tank Ohne Überlauf tank	Porcelain (White • Weiss)
		Platinum
		VIRP1220000
		VIRP7620000
		€ 18.055

COMPENSATION TANKS - ÜBERLAUFTANK

	Low compensation tank Mit herabgesetztem Überlauf tank	423630020
		€ 3.238
	Standard compensation tank Mit Standard-Überlauf tank	423630012
		€ 1.829

INSULATING COVER to be included in the order • WÄRMEABDECKUNG Muss im Auftrag enthalten sein

	ProVinyl	Ice	903002472
			€ 2.090

NOTE: Cover lifter not available • **HINWEIS:** Heber für Thermoabdeckung nicht verfügbar

ACCESSOIRES • ZUBEHÖRE

	Active Oxygen System	94360040
		€ 858
	AISI 316 L frame • Rahmen aus AISI 316 L	on request • auf Anfrage
		+ € 1.000

SPA PACK - Production from / Produktion ab May 2025

SPA PACK - Production from / Produktion ab May 2025			EUROPEAN STANDARD 220/240V F+N - OTHERS 380/415V 3F+N
	Single-phase Einphasig	With heater • Mit Heizung	3 kW
		Exchanger • Wärmetauscher	
			SPK94428790
			€ 5.653
			SPK94428800
			€ 6.050
			EUROPEAN STANDARD 380/415V 3F+N
			OTHERS 220/240V 3F
	Three-phase Dreiphasig	Without heater • Ohne Heizung	
		With heater • Mit Heizung	12 kW
		Exchanger • Wärmetauscher	
			SPK94428100
			€ 7.128
			SPK94428101
			€ 8.119
			SPK94428102
			€ 7.650



ENJOY PRO

Design Kaluderovic & Condini



250 x 250 x 98 H cm

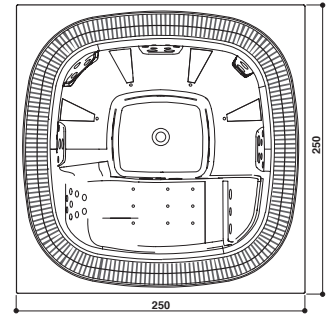

FEATURES • VERSIONEN

FEATURES • VERSIONEN		BUILT-IN
	Seats • Sitzflächen	6
	Lounge	1
	Jets • Düsen	38
	Blowers	15
	Underwater LED multicolor light • Mehrfarbige Unterwasser-LED-Leuchte	2
	Automatic water fill-up • Automatische Wasserbefüllung	✓
	Quick drain System • Schnelle Entleerung System	✓
	Without standard compensation tank Ohne Überlauf tank	Porcelain (White • Weiss)
		Platinum
		€ 14.195

COMPENSATION TANKS - ÜBERLAUFTANK

	Low compensation tank Mit herabgesetztem Überlauf tank	423630020
		€ 3.238
	Standard compensation tank Mit Standard-Überlauf tank	423630012
		€ 1.829

INSULATING COVER to be included in the order • WÄRMEABDECKUNG Muss im Auftrag enthalten sein

	ProVinyl	Ice	903001872
			€ 1.594

NOTE: Cover lifter not available • **HINWEIS:** Heber für Thermoabdeckung nicht verfügbar

ACCESSOIRES • ZUBEHÖRE

	Active Oxygen System	94360040
		€ 858
	AISI 316 L frame • Rahmen aus AISI 316 L	on request • auf Anfrage
		+ € 1.000

SPA PACK - Production from / Produktion ab May 2025

			EUROPEAN STANDARD 220/240V F+N - OTHERS 380/415V 3F+N
	Single-phase Einphasig	With heater • Mit Heizung	3 kW
		Exchanger • Wärmetauscher	
			SPK94428710
			€ 7.903
			SPK94428720
			€ 8.339
			EUROPEAN STANDARD 380/415V 3F+N
			OTHERS 220/240V 3F
	Three-phase Dreiphasig	Without heater • Ohne Heizung	
		With heater • Mit Heizung	12 kW
		Exchanger • Wärmetauscher	
			SPK94428400
			€ 8.556
			SPK94428401
			€ 9.596
			SPK94428402
			€ 9.676



VIRGINIA PRO

Jacuzzi® Design



257 x 219 x 98 H cm

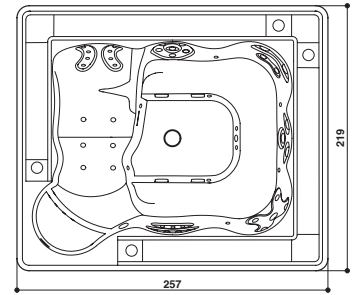
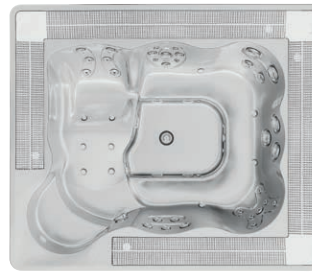

FEATURES • VERSIONEN

		BUILT-IN
	Seats • Sitzflächen	6-7
	Lounge	1
	Jets • Düsen	34
	Blowers	16
	Underwater LED multicolor light • Mehrfarbige Unterwasser-LED-Leuchte	✓
	Automatic water fill-up • Automatische Wasserbefüllung	✓
	Quick drain System • Schnelle Entleerung System	✓
	Without standard compensation tank Ohne Überlauf tank	Porcelain (White • Weiss)
		Platinum
		€ 16.824

COMPENSATION TANKS - ÜBERLAUFTANK

	Low compensation tank Mit herabgesetztem Überlauf tank	423630020
		€ 3.238
	Standard compensation tank Mit Standard-Überlauf tank	423630012
		€ 1.829

INSULATING COVER to be included in the order • WÄRMEABDECKUNG Muss im Auftrag enthalten sein

	ProVinyl	Ice	903001652
			€ 1.357

NOTE: Cover lifter not available • **HINWEIS:** Heber für Thermoabdeckung nicht verfügbar

ACCESSOIRES • ZUBEHÖRE

	Active Oxygen System	94360040
		€ 858
AISI 316 L frame • Rahmen aus AISI 316 L		on request • auf Anfrage
		+ € 1.000
SPA PACK - Production from / Produktion ab May 2025		EUROPEAN STANDARD 220/240V F+N - OTHERS 380/415V 3F+N
	Single-phase Einphasig	SPK94428710
	With heater • Mit Heizung	3 kW
Exchanger • Wärmetauscher		€ 7.903
		SPK94428720
		€ 8.339
		EUROPEAN STANDARD 380/415V 3F+N
		OTHERS 220/240V 3F
	Three-phase Dreiphasig	SPK94428400
	Without heater • Ohne Heizung	€ 8.556
	With heater • Mit Heizung	12 kW
Exchanger • Wärmetauscher		SPK94428401
		€ 9.596
		SPK94428402
		€ 9.676



SIENNA PRO

Jacuzzi® Design

257 x 219 x 98 H cm

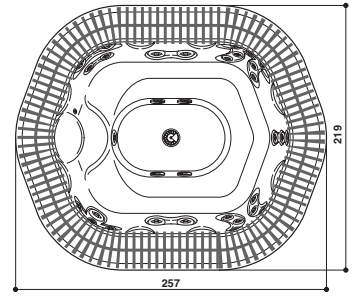

FEATURES • VERSIONEN

FEATURES • VERSIONEN		BUILT-IN
	Seats • Sitzflächen	7-8
	Jets • Düsen	30
	Blowers	16
	Underwater LED multicolor light • Mehrfarbige Unterwasser-LED-Leuchte	✓
	Automatic water fill-up • Automatische Wasserbefüllung	✓
	Quick drain System • Schnelle Entleerung System	✓
	Without standard compensation tank Ohne Überlauf tank	Porcelain (White • Weiss)
		Platinum
		€ 15.209

COMPENSATION TANKS - ÜBERLAUFTANK

	Low compensation tank Mit herabgesetztem Überlauf tank	423630020
		€ 3.238
	Standard compensation tank Mit Standard-Überlauf tank	423630012
		€ 1.829

INSULATING COVER to be included in the order • WÄRMEABDECKUNG Muss im Auftrag enthalten sein

	ProVinyl	Ice	903001662
			€ 1.274

NOTE: Cover lifter not available • **HINWEIS:** Heber für Thermoabdeckung nicht verfügbar

ACCESSOIRES • ZUBEHÖRE

	Active Oxygen System	94360040
		€ 858
	AISI 316 L frame • Rahmen aus AISI 316 L	on request • auf Anfrage
		+ € 1.000

SPA PACK - Production from / Produktion ab May 2025

			EUROPEAN STANDARD 220/240V F+N - OTHERS 380/415V 3F+N
	Single-phase Einphasig	With heater • Mit Heizung	3 kW
		Exchanger • Wärmetauscher	
			SPK94428710
			€ 7.903
			SPK94428720
			€ 8.339
			EUROPEAN STANDARD 380/415V 3F+N
			OTHERS 220/240V 3F
	Three-phase Dreiphasig	Without heater • Ohne Heizung	
		With heater • Mit Heizung	12 kW
		Exchanger • Wärmetauscher	
			SPK94428400
			€ 8.556
			SPK94428401
			€ 9.596
			SPK94428402
			€ 9.676

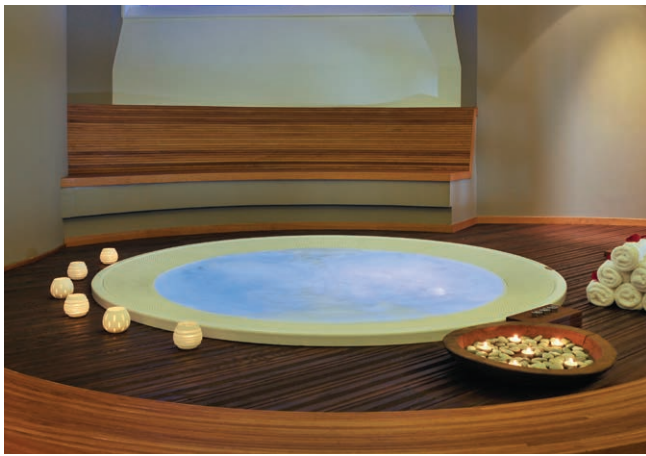

ALIMIA PRO

Jacuzzi® Design



Ø 237 x 98 H cm

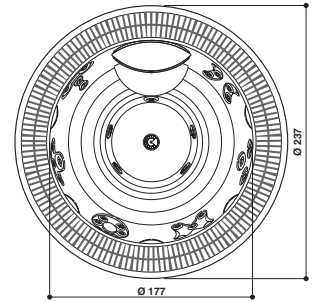

FEATURES • VERSIONEN

FEATURES • VERSIONEN		BUILT-IN
	Seats • Sitzflächen	6-7
	Jets • Düsen	28
	Blowers	16
	Underwater LED multicolor light • Mehrfarbige Unterwasser-LED-Leuchte	✓
	Automatic water fill-up • Automatische Wasserbefüllung	✓
	Quick drain System • Schnelle Entleerung System	✓
	Without standard compensation tank Ohne Überlauf tank	Porcelain (White • Weiss)
		Platinum
		€ 16.051

COMPENSATION TANKS - ÜBERLAUFTANK

	Low compensation tank Mit herabgesetztem Überlauf tank	423630020
		€ 3.238
	Standard compensation tank Mit Standard-Überlauf tank	423630012
		€ 1.829

INSULATING COVER to be included in the order • WÄRMEABDECKUNG Muss im Auftrag enthalten sein

	ProVinyl	Ice	903001712
			€ 1.274

NOTE: Cover lifter not available • **HINWEIS:** Heber für Thermoabdeckung nicht verfügbar

ACCESSOIRES • ZUBEHÖRE

	Active Oxygen System	94360040
		€ 858
	AISI 316 L frame • Rahmen aus AISI 316 L	on request • auf Anfrage
		+ € 1.000
		EUROPEAN STANDARD 220/240V F+N - OTHERS 380/415V 3F+N

SPA PACK - Production from / Produktion ab May 2025

	Single-phase Einphasig	With heater • Mit Heizung	3 kW	SPK94428710
				€ 7.903
		Exchanger • Wärmetauscher		SPK94428720
				€ 8.339
				EUROPEAN STANDARD 380/415V 3F+N
				OTHERS 220/240V 3F
	Three-phase Dreiphasig	Without heater • Ohne Heizung		SPK94428400
				€ 8.556
		With heater • Mit Heizung	12 kW	SPK94428401
				€ 9.596
		Exchanger • Wärmetauscher		SPK94428402
				€ 9.676



VIRTUS PRO



ALIMIA PRO

Golfo dei poeti Relais & Spa, Italia

A modern outdoor deck with a Jacuzzi hot tub, a sofa, and a view of a landscape at dusk. The hot tub is illuminated with blue and red lights. The deck is made of dark wood planks and has a pattern of light-colored tiles. In the background, there is a green landscape and a sunset sky.

Jacuzzi®

SWIM S

SmartTub®

new

PA

J-19 DT PowerPro™



J-19 DT PowerPro™

Design Jacuzzi®



561 x 234 x 134 H

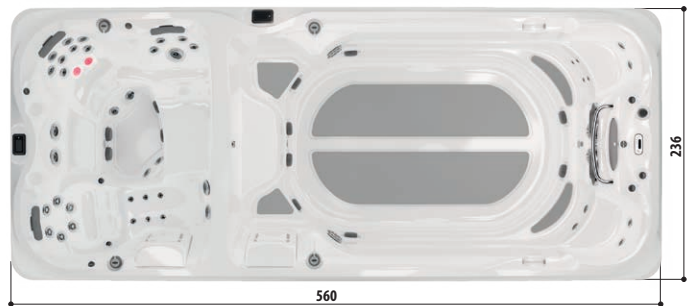

FEATURES • VERSIONEN

	PowerPro® Swim PX Jets • Düsen PowerPro® Swim PX	2
	Buoyancy Jet • Schwebedüse	2
	Jets • Düsen	43
	FX-IR + RX Therapy Seat • FX-IR + RX Therapy Seat	2
new	Swim Selector Control • Kommando Swim Selector	1
	Hydromassage seats • Sitzflächen des Whirlpools	4 + 2 Lounge
new	Cool Down Seats at entry • Cool Down Seats at entry	2
	Pro360™ Standing Therapy Wall • Pro360™ Stehende Therapie-Wand	--
	SmartTub®	✓
	WaterColour™ Waterfall • WaterColour™ Wasserfall	✓
new	Stainless Steel Swim Bar 60 cm (factory fitted, above Swim jets) Schwimmbar aus Edelstahl 60 cm (über den Düsen Swim - vormontiert)	✓
	Stainless Steel Exercise Bar 120 cm (factory fitted, left side only) Trainingsstange aus Edelstahl 120 cm (nur linke Seite - vormontiert)	--
new	Illuminated Grab Bars • Beleuchtete Haltegriffe	2
	Elastic cable with belt for static swimming Elastisches Band mit Gurt für stationäres Schwimmen	✓
	Light System LED Multicolour • Mehrfarbige Unterwasser-LED-Leuchte	✓
	CLEARRAY Active Oxygen® System	✓
	Pillow headrest • Kopfstütze	3
	Non-slip walking surfaces • Rutschfeste Laufflächen	✓
	Perma insulated floor • Boden mit Wärmeisolierung	✓
	Double electric heater • Doppeltes elektrisches Heizgerät	✓
	By-pass for auxiliary heating • Bypass für Zusatzheizung	✓

CONFIGURATIONS • KONFIGURATIONEN		BUILT-IN		FREESTANDING	
		FINISHING AUSFÜHRUNGEN		BRUSHED GREY	SMOKED EBONY
	Porcelain (White)	SA76301ENHM	SA763U1ENHM	SA763Y1ENHM	
	Platinum	SA12301ENHM	SA123U1ENHM	SA123Y1ENHM	
	Silver Pearl	SA33301ENHM	SA333U1ENHM	SA333Y1ENHM	
	SmartTub® Double electric heater Doppeltes elektrisches Heizgerät				
		€ 49.015	€ 52.500		

INSULATING COVER to be included in the order • WÄRMEABDECKUNG Muss im Auftrag enthalten sein

	Rigid thermal cover in 5 parts	ProLast® Grey	903004200	€ 3.030
	Roll-up thermal cover	Charcoal grey	903004220	€ 5.790
	Bracket for Rollaway® cover • Bügel für Auflage der Rollabdeckung		890011330	€ 625

NOTE: Cover lifter not available • **HINWEIS:** Heber für Thermoabdeckung nicht verfügbar

ACCESSOIRES • ZUBEHÖRE

	Power Tone Kit (bag with aquagym tools)		890011640	€ 599
	Non-slip 5-step entry system with handrail and railing	Black • Schwarz	890011560	€ 2.071





J-19 DT PowerActive™ SmartTub®

Design Jacuzzi®

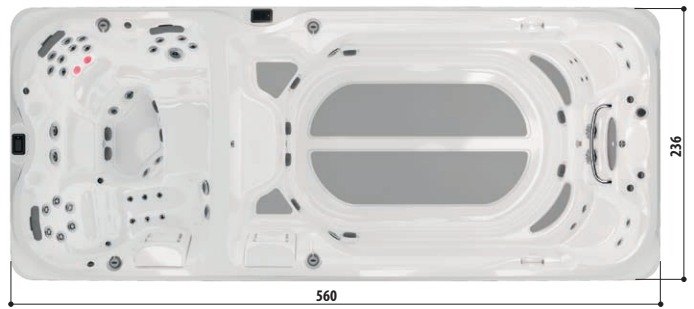
561 x 234 x 134 H





FEATURES • VERSIONEN

	PowerPro® Swim AX Jets • Düsen PowerPro® Swim AX	3
	Buoyancy Jet • Schwebedüse	2
	Jets • Düsen	43
	FX-IR + RX Therapy Seat • FX-IR + RX Therapy Seat	2
	Swim Selector Control • Kommando Swim Selector	--
	Hydromassage seats • Sitzflächen des Whirlpools	4 + 2 Lounge
	Cool Down Seats at entry • Cool Down Seats at entry	2
	Pro360™ Standing Therapy Wall • Pro360™ Stehende Therapie-Wand	--
	SmartTub®	✓
	WaterColour™ Waterfall • WaterColour™ Wasserfall	✓
	Stainless Steel Swim Bar 60 cm (factory fitted, above Swim jets) Schwimmbar aus Edelstahl 60 cm (über den Düsen Swim - vormontiert)	✓
	Stainless Steel Exercise Bar 120 cm (factory fitted, left side only) Trainingsstange aus Edelstahl 120 cm (nur linke Seite - vormontiert)	--
	Illuminated Grab Bars • Beleuchtete Haltegriffe	2
	Elastic cable with belt for static swimming Elastisches Band mit Gurt für stationäres Schwimmen	✓
	Light System LED Multicolour • Mehrfarbige Unterwasser-LED-Leuchte	✓
	CLEARRAY Active Oxygen® System	✓
	Pillow headrest • Kopfstütze	3
	Non-slip walking surfaces • Rutschfeste Laufflächen	✓
	Perma insulated floor • Boden mit Wärmeisolierung	✓
	Double electric heater • Doppeltes elektrisches Heizgerät	✓
	By-pass for auxiliary heating • Bypass für Zusatzheizung	✓



CONFIGURATIONS • KONFIGURATIONEN		BUILT-IN		FREESTANDING	
		--		BRUSHED GREY	SMOKED EBONY
	SmartTub®	FINISHING AUSFÜHRUNGEN			
	Double electric heater	Porcelain (White)	SB76301ENHM	SB763U1ENHM	SB763Y1ENHM
	Doppeltes elektrisches Heizgerät	Platinum	SB12301ENHM	SB123U1ENHM	SB123Y1ENHM
		Silver Pearl	SB33301ENHM	SB333U1ENHM	SB333Y1ENHM
			€ 43.065	€ 46.500	

INSULATING COVER to be included in the order • WÄRMEABDECKUNG Muss im Auftrag enthalten sein

	Rigid thermal cover in 5 parts	ProLast® Grey	903004200	€ 3.030
	Roll-up thermal cover	Charcoal grey	903004220	€ 5.790
	Bracket for Rollaway® cover • Bügel für Auflage der Rollabdeckung		890011330	€ 625

NOTE: Cover lifter not available • **HINWEIS:** Heber für Thermoabdeckung nicht verfügbar

ACCESSOIRES • ZUBEHÖRE

	Power Tone Kit (bag with aquagym tools)		890011640	€ 599
	Non-slip 5-step entry system with handrail and railing	Black • Schwarz	890011560	€ 2.071



J-19 PowerPro™

Design Jacuzzi®



564 x 236 x 134 H cm

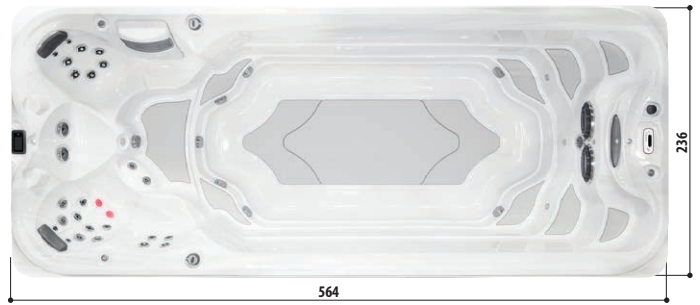

FEATURES • VERSIONEN

	PowerPro® Swim PX Jets • Düsen PowerPro® Swim PX	2
	Buoyancy Jet • Schwebedüse	2
	Jets • Düsen	26
	FX-IR + RX Therapy Seat • FX-IR + RX Therapy Seat	2
new	Swim Selector Control • Kommando Swim Selector	1
	Hydromassage seats • Sitzflächen des Whirlpools	4
new	Cool Down Seats at entry • Cool Down Seats at entry	2
	Pro360™ Standing Therapy Wall • Pro360™ Stehende Therapie-Wand	--
	SmartTub®	✓
	WaterColour™ Waterfall • WaterColour™ Wasserfall	✓
new	Stainless Steel Swim Bar 60 cm (factory fitted, above Swim jets) Schwimmbar aus Edelstahl 60 cm (über den Düsen Swim - vormontiert)	✓
	Stainless Steel Exercise Bar 120 cm (factory fitted, left side only) Trainingsstange aus Edelstahl 120 cm (nur linke Seite - vormontiert)	✓
	Illuminated Grab Bars • Beleuchtete Haltegriffe	--
	Elastic cable with belt for static swimming Elastisches Band mit Gurt für stationäres Schwimmen	✓
	Light System LED Multicolour • Mehrfarbige Unterwasser-LED-Leuchte	✓
	CLEARARRAY Active Oxygen® System	✓
	Pillow headrest • Kopfstütze	2
	Non-slip walking surfaces • Rutschfeste Laufflächen	✓
	Perma insulated floor • Boden mit Wärmeisolierung	✓
	Double electric heater • Doppeltes elektrisches Heizgerät	✓
	By-pass for auxiliary heating • Bypass für Zusatzheizung	✓

CONFIGURATIONS • KONFIGURATIONEN		BUILT-IN		FREESTANDING	
		--		BRUSHED GREY	SMOKED EBONY
	Stainless Steel Exercise Bar 120 cm (factory fitted, left side only) Trainingsstange aus Edelstahl 120 cm (nur linke Seite - vormontiert)	Porcelain (White)	SC76301ENHM	SC763U1ENHXM	SC763Y1ENHXM
		Platinum	SC12301ENHM	SC123U1ENHXM	SC123Y1ENHXM
		Silver Pearl	SC33301ENHM	SC333U1ENHXM	SC333Y1ENHXM
		€ 46.594		€ 49.905	

INSULATING COVER to be included in the order • WÄRMEABDECKUNG Muss im Auftrag enthalten sein

	Rigid thermal cover in 5 parts	ProLast® Grey	903003440	€ 2.835
	Roll-up thermal cover	Charcoal grey	903003520	€ 5.621
	Bracket for Rollaway® cover • Bügel für Auflage der Rollabdeckung		890011330	€ 625

NOTE: Cover lifter not available • **HINWEIS:** Heber für Thermoabdeckung nicht verfügbar

ACCESSOIRES • ZUBEHÖRE

	Power Tone Kit (bag with aquagym tools)		890011640	€ 599
	Non-slip 5-step entry system with handrail and railing	Black • Schwarz	890011560	€ 2.071



J-19 PowerActive™

Design Jacuzzi®



564 x 236 x 134 H cm

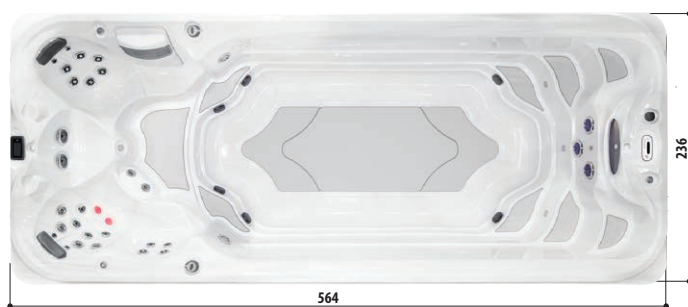

FEATURES • VERSIONEN

	PowerPro® Swim AX Jets • Düsen PowerPro® Swim AX	3
	Buoyancy Jet • Schwebedüse	2
	Jets • Düsen	26
	FX-IR + RX Therapy Seat • FX-IR + RX Therapy Seat	2
	Swim Selector Control • Kommando Swim Selector	--
	Hydromassage seats • Sitzflächen des Whirlpools	4
	Cool Down Seats at entry • Cool Down Seats at entry	2
	Pro360™ Standing Therapy Wall • Pro360™ Stehende Therapie-Wand	--
	SmartTub®	✓
	WaterColour™ Waterfall • WaterColour™ Wasserfall	✓
	Stainless Steel Swim Bar 60 cm (factory fitted, above Swim jets) Schwimmbar aus Edelstahl 60 cm (über den Düsen Swim - vormontiert)	✓
	Stainless Steel Exercise Bar 120 cm (factory fitted, left side only) Trainingsstange aus Edelstahl 120 cm (nur linke Seite - vormontiert)	✓
	Illuminated Grab Bars • Beleuchtete Haltegriffe	--
	Elastic cable with belt for static swimming Elastisches Band mit Gurt für stationäres Schwimmen	✓
	Light System LED Multicolour • Mehrfarbige Unterwasser-LED-Leuchte	✓
	CLEARRAY Active Oxygen® System	✓
	Pillow headrest • Kopfstütze	2
	Non-slip walking surfaces • Rutschfeste Laufflächen	✓
	Perma insulated floor • Boden mit Wärmeisolierung	✓
	Double electric heater • Doppeltes elektrisches Heizgerät	✓
	By-pass for auxiliary heating • Bypass für Zusatzheizung	✓

CONFIGURATIONS • KONFIGURATIONEN		BUILT-IN		FREESTANDING	
		--		BRUSHED GREY	SMOKED EBONY
	Stainless Steel Exercise Bar 120 cm (factory fitted, left side only) Trainingsstange aus Edelstahl 120 cm (nur linke Seite - vormontiert)	Porcelain (White)	SF76301ENHM	SF763U1ENHXM	SF763Y1ENHXM
		Platinum	SF12301ENHM	SF123U1ENHXM	SF123Y1ENHXM
		Silver Pearl	SF33301ENHM	SF333U1ENHXM	SF333Y1ENHXM
		€ 40.588		€ 43.824	

INSULATING COVER to be included in the order • WÄRMEABDECKUNG Muss im Auftrag enthalten sein

	Rigid thermal cover in 5 parts	ProLast® Grey	903003440	€ 2.835
	Roll-up thermal cover	Charcoal grey	903003520	€ 5.621
	Bracket for Rollaway® cover • Bügel für Auflage der Rollabdeckung		890011330	€ 625

NOTE: Cover lifter not available • **HINWEIS:** Heber für Thermoabdeckung nicht verfügbar

ACCESSOIRES • ZUBEHÖRE

	Power Tone Kit (bag with aquagym tools)		890011640	€ 599
	Non-slip 5-step entry system with handrail and railing	Black • Schwarz	890011560	€ 2.071



J-16 PowerPro™

Design Jacuzzi®



472 x 236 x 134 H cm

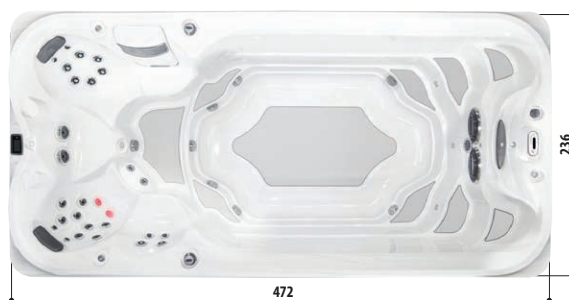

FEATURES • VERSIONEN

	PowerPro® Swim PX Jets • Düsen PowerPro® Swim PX	2
	Buoyancy Jet • Schwebedüse	2
	Jets • Düsen	26
	FX-IR + RX Therapy Seat • FX-IR + RX Therapy Seat	2
new	Swim Selector Control • Kommando Swim Selector	1
	Hydromassage seats • Sitzflächen des Whirlpools	4
new	Cool Down Seats at entry • Cool Down Seats at entry	2
	Pro360™ Standing Therapy Wall • Pro360™ Stehende Therapie-Wand	--
	SmartTub®	✓
	WaterColour™ Waterfall • WaterColour™ Wasserfall	✓
new	Stainless Steel Swim Bar 60 cm (factory fitted, above Swim jets) Schwimmbar aus Edelstahl 60 cm (über den Düsen Swim - vormontiert)	✓
	Stainless Steel Exercise Bar 120 cm (factory fitted, left side only) Trainingsstange aus Edelstahl 120 cm (nur linke Seite - vormontiert)	✓
	Illuminated Grab Bars • Beleuchtete Haltegriffe	--
	Elastic cable with belt for static swimming Elastisches Band mit Gurt für stationäres Schwimmen	✓
	Light System LED Multicolour • Mehrfarbige Unterwasser-LED-Leuchte	✓
	CLEARRAY Active Oxygen® System	✓
	Pillow headrest • Kopfstütze	2
	Non-slip walking surfaces • Rutschfeste Laufflächen	✓
	Perma insulated floor • Boden mit Wärmeisolierung	✓
	Double electric heater • Doppeltes elektrisches Heizgerät	✓
	By-pass for auxiliary heating • Bypass für Zusatzheizung	✓

CONFIGURATIONS • KONFIGURATIONEN		BUILT-IN		FREESTANDING	
		--		BRUSHED GREY	SMOKED EBONY
	Stainless Steel Exercise Bar 120 cm (factory fitted, left side only)	Porcelain (White)	SJ76301ENHM	SJ763U1ENHXM	SJ763Y1ENHXM
	Stainless Steel Exercise Bar 120 cm (factory fitted, left side only)	Platinum	SJ12301ENHM	SJ123U1ENHXM	SJ123Y1ENHXM
	Stainless Steel Exercise Bar 120 cm (factory fitted, left side only)	Silver Pearl	SJ33301ENHM	SJ333U1ENHXM	SJ333Y1ENHXM
			€ 42.242	€ 45.189	

INSULATING COVER to be included in the order • WÄRMEABDECKUNG Muss im Auftrag enthalten sein

	Rigid thermal cover in 5 parts	ProLast® Grey	903003450	€ 2.625
	Roll-up thermal cover	Charcoal grey	903003540	€ 4.882
	Bracket for Rollaway® cover • Bügel für Auflage der Rollabdeckung		890011330	€ 625

NOTE: Cover lifter not available • **HINWEIS:** Heber für Thermoabdeckung nicht verfügbar

ACCESSOIRES • ZUBEHÖRE

	Power Tone Kit (bag with aquagym tools)		890011640	€ 599
	Non-slip 5-step entry system with handrail and railing	Black • Schwarz	890011560	€ 2.071



J-16 PowerActive™

Design Jacuzzi®



472 x 236 x 134 H cm



FEATURES • VERSIONEN

	PowerPro® Swim AX Jets • Düsen PowerPro® Swim AX	3
	Buoyancy Jet • Schwebedüse	2
	Jets • Düsen	26
	FX-IR + RX Therapy Seat • FX-IR + RX Therapy Seat	2
	Swim Selector Control • Kommando Swim Selector	--
	Hydromassage seats • Sitzflächen des Whirlpools	4
	Cool Down Seats at entry • Cool Down Seats at entry	2
	Pro360™ Standing Therapy Wall • Pro360™ Stehende Therapie-Wand	--
	SmartTub®	✓
	WaterColour™ Waterfall • WaterColour™ Wasserfall	✓
	Stainless Steel Swim Bar 60 cm (factory fitted, above Swim jets) Schwimmbar aus Edelstahl 60 cm (über den Düsen Swim - vormontiert)	✓
	Stainless Steel Exercise Bar 120 cm (factory fitted, left side only) Trainingsstange aus Edelstahl 120 cm (nur linke Seite - vormontiert)	✓
	Illuminated Grab Bars • Beleuchtete Haltegriffe	--
	Elastic cable with belt for static swimming Elastisches Band mit Gurt für stationäres Schwimmen	✓
	Light System LED Multicolour • Mehrfarbige Unterwasser-LED-Leuchte	✓
	CLEARRAY Active Oxygen® System	✓
	Pillow headrest • Kopfstütze	2
	Non-slip walking surfaces • Rutschfeste Laufflächen	✓
	Perma insulated floor • Boden mit Wärmeisolierung	✓
	Double electric heater • Doppeltes elektrisches Heizgerät	✓
	By-pass for auxiliary heating • Bypass für Zusatzheizung	✓

CONFIGURATIONS • KONFIGURATIONEN		BUILT-IN		FREESTANDING	
		--		BRUSHED GREY	SMOKED EBONY
	Stainless Steel Exercise Bar 120 cm (factory fitted, left side only) Trainingsstange aus Edelstahl 120 cm (nur linke Seite - vormontiert)	Porcelain (White)	SM76301ENHM	SM763U1ENHXM	SM763Y1ENHXM
		Platinum	SM12301ENHM	SM123U1ENHXM	SM123Y1ENHXM
		Silver Pearl	SM33301ENHM	SM333U1ENHXM	SM333Y1ENHXM
			€ 36.666	€ 39.571	

INSULATING COVER to be included in the order • WÄRMEABDECKUNG Muss im Auftrag enthalten sein

	Rigid thermal cover in 5 parts	ProLast® Grey	903003450	€ 2.625
	Roll-up thermal cover	Charcoal grey	903003540	€ 4.882
	Bracket for Rollaway® cover • Bügel für Auflage der Rollabdeckung		890011330	€ 625

NOTE: Cover lifter not available • **HINWEIS:** Heber für Thermoabdeckung nicht verfügbar

ACCESSOIRES • ZUBEHÖRE

	Power Tone Kit (bag with aquagym tools)		890011640	€ 599
	Non-slip 5-step entry system with handrail and railing	Black • Schwarz	890011560	€ 2.071



J-14 PowerPro™

Design Jacuzzi®



437 x 234 x 134 H cm



FEATURES • VERSIONEN

	PowerPro® Swim PX Jets • Düsen PowerPro® Swim PX	2
	Buoyancy Jet • Schwebedüse	2
	Jets • Düsen	43
	FX-IR + RX Therapy Seat • FX-IR + RX Therapy Seat	2
new	Swim Selector Control • Kommando Swim Selector	1
	Hydromassage seats • Sitzflächen des Whirlpools	3
new	Cool Down Seats at entry • Cool Down Seats at entry	2
new	Pro360™ Standing Therapy Wall • Pro360™ Stehende Therapie-Wand	✓
	SmartTub®	✓
	WaterColour™ Waterfall • WaterColour™ Wasserfall	✓
new	Stainless Steel Swim Bar 60 cm (factory fitted, above Swim jets) Schwimmbar aus Edelstahl 60 cm (über den Düsen Swim - vormontiert)	✓
	Stainless Steel Exercise Bar 120 cm (factory fitted, left side only) Trainingsstange aus Edelstahl 120 cm (nur linke Seite - vormontiert)	--
new	Illuminated Grab Bars • Beleuchtete Haltegriffe	2
	Elastic cable with belt for static swimming Elastisches Band mit Gurt für stationäres Schwimmen	✓
	Light System LED Multicolour • Mehrfarbige Unterwasser-LED-Leuchte	✓
	CLEARRAY Active Oxygen® System	✓
	Pillow headrest • Kopfstütze	2
	Non-slip walking surfaces • Rutschfeste Laufflächen	✓
	Perma insulated floor • Boden mit Wärmeisolierung	✓
	Double electric heater • Doppeltes elektrisches Heizgerät	✓
	By-pass for auxiliary heating • Bypass für Zusatzheizung	✓

CONFIGURATIONS • KONFIGURATIONEN	FINISHING AUSFÜHRUNGEN	BUILT-IN	FREESTANDING	
		--	BRUSHED GREY	SMOKED EBONY
SmartTub® Double electric heater Doppeltes elektrisches Heizgerät	Porcelain (White)	SN76301ENHM	SN763U1ENHM	SN763Y1ENHM
	Platinum	SN12301ENHM	SN123U1ENHM	SN123Y1ENHM
	Silver Pearl	SN33301ENHM	SN333U1ENHM	SN333Y1ENHM
		€ 38.400	€ 41.000	

INSULATING COVER to be included in the order • WÄRMEABDECKUNG Muss im Auftrag enthalten sein

	Rigid thermal cover in 5 parts	ProLast® Grey	903004190	€ 2.575
	Roll-up thermal cover	Charcoal grey	903004210	€ 4.659
	Bracket for Rollaway® cover • Bügel für Auflage der Rollabdeckung		890011330	€ 625

NOTE: Cover lifter not available • **HINWEIS:** Heber für Thermoabdeckung nicht verfügbar

ACCESSOIRES • ZUBEHÖRE

	Power Tone Kit (bag with aquagym tools)		890011640	€ 599
	Non-slip 5-step entry system with handrail and railing	Black • Schwarz	890011560	€ 2.071

new



J-14 PowerActive™

Design Jacuzzi®



437 x 234 x 134 H cm



FEATURES • VERSIONEN

	PowerPro® Swim AX Jets • Düsen PowerPro® Swim AX	3
	Buoyancy Jet • Schwebedüse	2
	Jets • Düsen	43
	FX-IR + RX Therapy Seat • FX-IR + RX Therapy Seat	2
	Swim Selector Control • Kommando Swim Selector	--
	Hydromassage seats • Sitzflächen des Whirlpools	3
	Cool Down Seats at entry • Cool Down Seats at entry	2
	Pro360™ Standing Therapy Wall • Pro360™ Stehende Therapie-Wand	✓
	SmartTub®	✓
	WaterColour™ Waterfall • WaterColour™ Wasserfall	✓
	Stainless Steel Swim Bar 60 cm (factory fitted, above Swim jets) Schwimmbar aus Edelstahl 60 cm (über den Düsen Swim - vormontiert)	✓
	Stainless Steel Exercise Bar 120 cm (factory fitted, left side only) Trainingsstange aus Edelstahl 120 cm (nur linke Seite - vormontiert)	--
	Illuminated Grab Bars • Beleuchtete Haltegriffe	2
	Elastic cable with belt for static swimming Elastisches Band mit Gurt für stationäres Schwimmen	✓
	Light System LED Multicolour • Mehrfarbige Unterwasser-LED-Leuchte	✓
	CLEARRAY Active Oxygen® System	✓
	Pillow headrest • Kopfstütze	2
	Non-slip walking surfaces • Rutschfeste Laufflächen	✓
	Perma insulated floor • Boden mit Wärmeisolierung	✓
	Double electric heater • Doppeltes elektrisches Heizgerät	✓
	By-pass for auxiliary heating • Bypass für Zusatzheizung	✓

CONFIGURATIONS • KONFIGURATIONEN	FINISHING AUSFÜHRUNGEN	BUILT-IN	FREESTANDING	
		--	BRUSHED GREY	SMOKED EBONY
SmartTub® Double electric heater Doppeltes elektrisches Heizgerät	Porcelain (White)	SP76301ENHM	SP763U1ENHM	SP763Y1ENHM
	Platinum	SP12301ENHM	SP123U1ENHM	SP123Y1ENHM
	Silver Pearl	SP33301ENHM	SP333U1ENHM	SP333Y1ENHM
		€ 33.400	€ 36.000	

INSULATING COVER to be included in the order • WÄRMEABDECKUNG Muss im Auftrag enthalten sein

	Rigid thermal cover in 5 parts	ProLast® Grey	903004190	€ 2.575
	Roll-up thermal cover	Charcoal grey	903004210	€ 4.659
	Bracket for Rollaway® cover • Bügel für Auflage der Rollabdeckung		890011330	€ 625

NOTE: Cover lifter not available • **HINWEIS:** Heber für Thermoabdeckung nicht verfügbar

ACCESSOIRES • ZUBEHÖRE

	Power Tone Kit (bag with aquagym tools)		890011640	€ 599
	Non-slip 5-step entry system with handrail and railing	Black • Schwarz	890011560	€ 2.071



J-13 PowerPlay™

Design Jacuzzi®



381 x 236 x 127 H cm

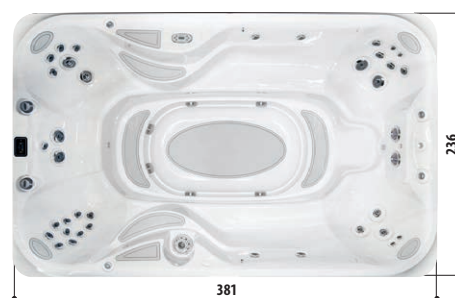

FEATURES • VERSIONEN

	PowerPlay® Swim CX Jets • Düsen PowerPlay® Swim CX	2
	Buoyancy Jet • Schwebedüse	--
	Jets • Düsen	36
	FX-IR + RX Therapy Seat • FX-IR + RX Therapy Seat	--
	Swim Selector Control • Kommando Swim Selector	--
	Hydromassage seats • Sitzflächen des Whirlpools	9
	Cool Down Seats at entry • Cool Down Seats at entry	✓
	Pro360™ Standing Therapy Wall • Pro360™ Stehende Therapie-Wand	--
	SmartTub®	✓
	WaterColour™ Waterfall • WaterColour™ Wasserfall	✓
	Stainless Steel Swim Bar 60 cm (factory fitted, above Swim jets) Schwimmbar aus Edelstahl 60 cm (über den Düsen Swim - vormontiert)	✓
	Stainless Steel Exercise Bar 120 cm (factory fitted, left side only) Trainingsstange aus Edelstahl 120 cm (nur linke Seite - vormontiert)	--
	Illuminated Grab Bars • Beleuchtete Haltegriffe	--
	Elastic cable with belt for static swimming Elastisches Band mit Gurt für stationäres Schwimmen	✓
	Light System LED Multicolour • Mehrfarbige Unterwasser-LED-Leuchte	✓
	CLEARRAY Active Oxygen® System	✓
	Pillow headrest • Kopfstütze	4
	Non-slip walking surfaces • Rutschfeste Laufflächen	✓
	Perma insulated floor • Boden mit Wärmeisolierung	✓
	Double electric heater • Doppeltes elektrisches Heizgerät	--
	By-pass for auxiliary heating • Bypass für Zusatzheizung	✓

CONFIGURATIONS • KONFIGURATIONEN		FREESTANDING	
		BRUSHED GREY	SMOKED EBONY
	Stainless Steel Swim Bar 60 cm (factory fitted, above Swim jets)	SO763U1ENMW	SO763Y1ENMW
	Schwimmbar aus Edelstahl 60 cm (über den Düsen Swim - vormontiert)	SO123U1ENMW	SO123Y1ENMW
		SO333U1ENMW	SO333Y1ENMW
		€ 29.405	

INSULATING COVER to be included in the order • WÄRMEABDECKUNG Muss im Auftrag enthalten sein

	Rigid thermal cover in 4 parts	ProLast® Grey	903003550	€ 2.490
	Roll-up thermal cover	Charcoal grey	903003570	€ 4.458
	Bracket for Rollaway® cover • Bügel für Auflage der Rollabdeckung		890011330	€ 625

NOTE: Cover lifter not available • **HINWEIS:** Heber für Thermoabdeckung nicht verfügbar

ACCESSOIRES • ZUBEHÖRE

	Power Tone Kit (bag with aquagym tools)		890011640	€ 599
	Non-slip 5-step entry system with handrail and railing	Black • Schwarz	890011560	€ 2.071

SWIM SPA

ACCESSORIES AND INSULATING COVER

ZUBEHÖR UND WÄRMEABDECKUNG

ACCESSOIRES ZUBEHÖRE	Description Beschreibung		Code Kode	
	Power Tone Kit - bag with aquagym tools Swing Trainer + Hydro bells + Resistance training fins Power Tone Kit - Tasche mit Geräten für Wassergymnastik Swing Trainer + Hydro bells + Resistance training fins	Optional	890011640 € 599	
	Elastic cable with belt for static swimming Elastisches Band mit Gurt für stationäres Schwimmen	Included in models Gehört zum Lieferumfang der Modelle PowerPro™ PowerActive™ PowerPlay™	890011630 € 69	
	Non-slip 5-step entry system with handrail and railing. Black 5-stufige, rutschfeste Trittleiter mit Handleiste und Brüstung. Schwarz	L 76,2 x P 152,4 x H 88,9 cm Single Step / Eine Stufe L 76,2 x P 25,4 x H 17,8 cm Top platform / Obere Plattform L 76,2 x P 50,8 cm	890011560 € 2.071	
INSULATING COVER WÄRMEABDECKUNG	Model Modell	Material Material	Finishing Oberflächenzubehör	Codice Code Kode
	SWIM SPA J-19 DT	Prolast™	Grey • Grau	903004200 € 3.030
	SWIM SPA J-19	Prolast™	Grey • Grau	903003440 € 2.835
	SWIM SPA J-16	Prolast™	Grey • Grau	903003450 € 2.625
	SWIM SPA J-14	Prolast™	Grey • Grau	903004190 € 2.575
	SWIM SPA J-13	Prolast™	Grey • Grau	903003550 € 2.490
	SWIM SPA J-19 DT L. 564 x P. 238 cm	Rollaway®	Charcoal grey Anthrazitgrau	903004220 € 5.790
	SWIM SPA J-19 L. 564 x P. 238 cm			903003520 € 5.621
	SWIM SPA J-16 L. 478 x P. 238 cm			903003540 € 4.882
	SWIM SPA J-14 L. 478 x P. 238 cm			903004210 € 4.659
	SWIM SPA J-13 L. 386 x P. 238 cm			903003570 € 4.458
Rollaway® is 12 kg / meter. Once rolled up, the diameter is about 70 cm.		Rollaway® wiegt 12 kg pro Meter. Im aufgerollten Zustand beträgt der Durchmesser ungefähr 70 cm.		
	Bracket for Rollaway® cover Bügel für Auflage der Rollabdeckung L. 61 cm x H. 71 cm			890011330 € 625

NOTE: Accessories marked with dedicated codes to be ordered separately are not included or installed on the product.

NOTE: Optional und accessoires, die mit entsprechenden Codes gekennzeichnet sind, die separat bestellt werden müssen, sind nicht im Produkt inbegriffen oder installiert.

OUTDOOR SHOWER COLUMN DUSCHSÄULE FÜR AUSSENBEREICHE

MADE IN ITALY



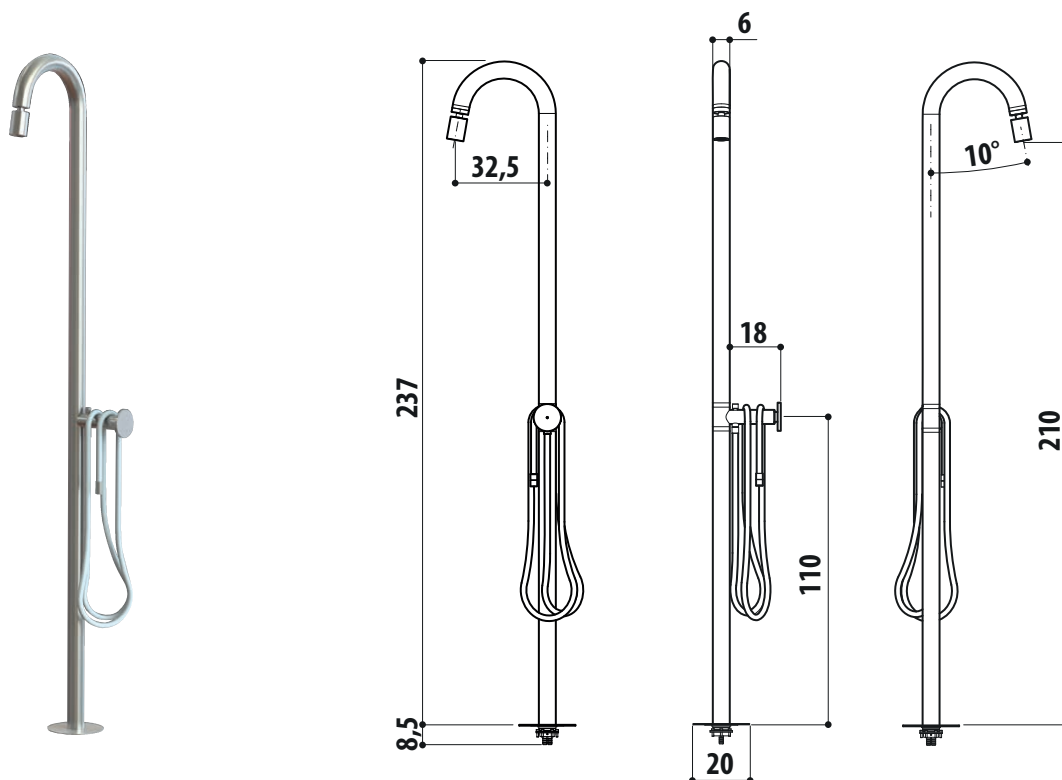

Design Nespoli_Novara - Design Jacuzzi®



Description Beschreibung	Dimensions Abmessungen	Code Kode
<p>Outdoor shower column, matte stainless steel 316L with progressive single-lever mixer (cold-hot water) and grey silicone rubber hose.</p> <p>Duschsäule für Außenbereiche aus satiniertem Edelstahl 316L mit Einhandmischer mit progressiver Kartusche (Kalt-Heißwasser), flexibel aus Silikongummi, Grau.</p>	<p>Ø 6 x 237 H cm</p>	<p>228501130</p> <p>€ 3.442</p>
<p>Recessed body for outdoor shower column (to be paired with code 228501130)</p> <p>Einbaugehäuse für Duschsäule für Außenbereiche (für die Kombination mit dem Code 228501130)</p>	<p>Ø 20 x 8,5 H cm</p>	<p>228501150</p> <p>€ 235</p>

SPA ACCESSORIES ZUBEHÖR

Jacuzzi

	Description Beschreibung	Dimensions Abmessungen	Finishing Oberflächenzubehör	Code Kode
STEPS · STUFE				
	VersaStep™ - 2 steps VersaStep™ - zweistufig	75 x 50 x 35 H cm	BRUSHED GREY	890011360 € 602
	VersaStep™ - 2 steps VersaStep™ - zweistufig	75 x 50 x 35 H cm	MODERN HARDWOOD	890011350 € 602
	VersaStep™ - 2 steps VersaStep™ - zweistufig	75 x 50 x 35 H cm	SMOKED EBONY	890011370 € 602
	Smart Step - 2 steps Smart Step - zweistufig	90 x 60 x 40 H cm	BLACK • SCHWARZ	890011600 € 526

COVER LIFTER · LIFT FÜR WÄRMEABDECKUNG

	Specific for the models of the collection • Speziell für den Modellen der Kollektion J-495™ Cover lifter hydraulic assist - fastening on panel Dimension: rear 40 cm, side 15 cm each side Hydraulischer Heber für Wärmeabdeckung - Verankerung im Paneel Größe: hinten 40 cm, seitlich 15 cm auf jeder Seite			890011520 € 865
	Specific for the models of the collection • Speziell für den Modellen der Kollektion J-485™-J-475™, J-445™-J-435™ Cover lifter hydraulic assist - fastening on panel Dimension: rear 40 cm, side 15 cm each side Hydraulischer Heber für Wärmeabdeckung - Verankerung im Paneel Größe: hinten 40 cm, seitlich 15 cm auf jeder Seite			890011510 € 865
	Compatible with the models of the collection • Kompatibel mit den Modellen der Kollektion J-LX®, J-300™, J-200™ Classic Cover lifter hydraulic assist - fastening on panel Dimension: rear 30 cm, side 15 cm Hydraulischer Heber für Wärmeabdeckung - Verankerung im Paneel Größe: hinten 30 cm, seitlich 15 cm			890011460 € 757
	Compatible with the models of the collection • Kompatibel mit den Modellen der Kollektion J-LX®, J-300™, J-200™ Classic Cover lifter manual - fastening on panel Dimension: rear 30 cm, side 15 cm Manueller Lift für Wärmeabdeckung - Verankerung im Paneel Größe: hinten 30 cm, seitlich 15 cm			890011450 € 541
	Compatible with the models of the collection • Kompatibel mit den Modellen der Kollektion J-400™, J-LX®, J-300™, J-200™ Classic, LODGE+ Cover lifter undermount manual - fastening on base Dimension: rear 45 cm, side 15 cm Manueller Lift für Wärmeabdeckung - Verankerung in der Basis Größe: hinten 45 cm, seitlich 15 cm			890011500 € 865
	Specific for the models of the collection • Speziell für den Modellen der Kollektion J-300™ - J-200™ Classic Cover lifter manual drop-behind - fastening on panel Dimension: rear 40 cm, side 15 cm Manueller Lift für Wärmeabdeckung (hinter dem Whirlpool) - Verankerung im Paneel Größe: hinten 40 cm, seitlich 15 cm			890011440 € 1.310

OPTIONAL

	SmartTub® Wireless Sensor Kit Includes Spa Cover Sensor + Drain and Fill Sensors + Water Sensor Kit Wireless-Sensoren SmartTub® Umfasst Sensor der Wärmeabdeckung + Sensoren für Ablauf und Befüllung - Wassersensor	919405450 € 560
Compatible with the models of the collection with SmartTub® • Kompatibel mit den Modellen der Kollektion mit SmartTub® J-LX® - J-400™ - J-300™		



INSULATING COVER WÄRMEABDECKUNG

Model Modell	Material	Finishing Oberflächenzubehör	Code Kode	Price Preis
J-400™ COLLECTION				
J-495™	PROLAST™	Black • Schwarz	903003260	€ 2.004
J-485™ / J-475™	PROLAST™	Black • Schwarz	903003330	€ 1.475
J-445™ / J-435™	PROLAST™	Black • Schwarz	903003420	€ 1.386
J-LX® COLLECTION				
J-LX® / J-LXL®	PROLAST™	Black • Schwarz	903003950	€ 1.500
J-300™ COLLECTION				
J-385™ / J-375™	PROLAST™	Black • Schwarz	903002941	€ 1.491
J-365™ / J-355™	PROLAST™	Black • Schwarz	903003221	€ 1.398
J-345™ / J-335™ / J-332™	PROLAST™	Black • Schwarz	903002411	€ 1.395
J-325™	PROLAST™	Black • Schwarz	903003590	€ 1.328
J-315™	PROLAST™	Black • Schwarz	903003611	€ 1.203
J-200™ CLASSIC COLLECTION				
J-235™ Classic	PROLAST™	Black • Schwarz	903003211	€ 1.110

Model Modell	Material Material	Finshing Oberflächenzubehör	Code Kode	Price Preis
-----------------	----------------------	--------------------------------	--------------	----------------

DESIGN COLLECTION

VIRTUS	ProVinyl	Ice	903002472	€ 2.090
PROFILE	ProVinyl	Ice	903002202	€ 1.257
SANTORINI	ProVinyl	Ice	903001482	€ 1.367
DELOS	ProVinyl	Ice	903001542	€ 1.129
DELFI	ProVinyl	Ice	903001562	€ 1.063
UNIQUE	ProVinyl	Ice	903001682	€ 919
CITY™ SPA	ProVinyl	Ice	903001732	€ 851
ALIMIA	ProVinyl	Ice	903001672	€ 1.137

LODGE+ COLLECTION

LODGE+ L	ProVinyl	Grey • Grau	903001972	€ 1.286
LODGE+ M	ProVinyl	Grey • Grau	903001902	€ 1.141
LODGE+ S	ProVinyl	Grey • Grau	903001982	€ 911

PROFESSIONAL COLLECTION

VIRTUS PRO	ProVinyl	Ice	903002472	€ 2.090
ENJOY PRO	ProVinyl	Ice	903001872	€ 1.594
VIRGINIA PRO	ProVinyl	Ice	903001652	€ 1.357
SIENNA PRO	ProVinyl	Ice	903001662	€ 1.274
ALIMIA PRO	ProVinyl	Ice	903001712	€ 1.274

COLORS, MATERIALS AND FINISHES

FARBEN, MATERIALIEN UND AUSFÜHRUNGEN

COLLECTIONS KOLLEKTION	SHELL COLOR · FARBEN (SCHALE)			
	ACRYLIC / ACRYL			
	Platinum	Porcelain (White · Weiss)	Silver Pearl	Midnight
J-400™	X		X	X
J-LX®	X	X		
J-300™	X	Made in Italy	X	X
J-200™ Classic	X	On demand · Auf Anfrage	On demand · Auf Anfrage	On demand · Auf Anfrage
DESIGN	X	X		
LODGE+	X	X		
PROFESSIONAL	X	X		
SWIM SPA	X	X	X	

COLLECTIONS KOLLEKTION	CABINET COLOR · PANEELAUSFÜHRUNGEN								
	PROFINISH™			SYNTHETIC WOOD HOLZIMITAT			WOOD HOLZ	COMPOSITE-PVC VERBUNDWERKSTOFF-PVC	
	Brushed Grey	Modern Hardwood	Smoked Ebony	Silverwood	Roasted Chestnut	Graphite	Teak	White Oak	Grey Oak
J-400™	X	X	X						
J-LX®	X	X	X						
J-300™	X	Except / Außer Made in Italy	X						
J-200™ Classic				X					
DESIGN						X*	X*	City™ Spa Unique	City™ Spa Unique
LODGE+				X	X				
PROFESSIONAL									
SWIM SPA	X		X						

COLLECTIONS KOLLEKTION	COVER COLOR · WÄRMEABDECKUNG				
	PROLAST™		PROVINYL		ROLLAWAY®
	Black Schwarz	Grey Grau	Ice	Grey Grau	Charcoal grey Anthrazitgrau
J-400™	X				
J-LX®	X				
J-300™	X				
J-200™ Classic	X				
DESIGN			X		
LODGE+				X	
PROFESSIONAL			X		
SWIM SPA		X			X

* Check on price list by model · * In der Preisliste für das Modell prüfen

PLATINUM



PORCELAIN
(WHITE • WEISS)

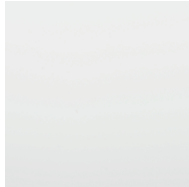

SILVER PEARL



MIDNIGHT

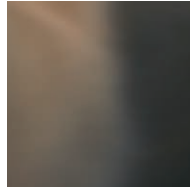

ProFinish™

BRUSHED GREY



MODERN HARDWOOD



SMOKED EBONY



Synthetic wood • Holzimitat

SILVERWOOD



ROASTED CHESTNUT

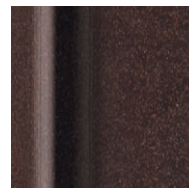

GRAPHITE



Wood • Holz
TEAK



Composite-PVC • Verbundwerkstoff-PVC
WHITE OAK

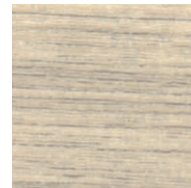

GREY OAK



Prolast™

BLACK • SCHWARZ

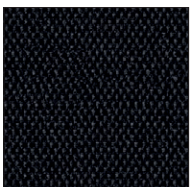

GREY • GRAU



Provinyl
ICE

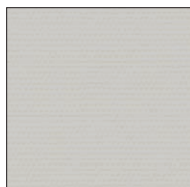

GREY • GRAU

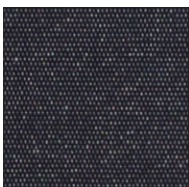

Rollaway®

CHARCOAL GREY • ANTHRAZITGRAU

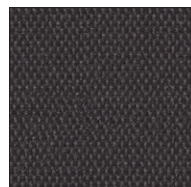

Art. 1 General provisions

1.1. The current general terms, except for any exceptions specifically agreed in writing, enforce all current and future sales contracts between parties, even in the absence of an express reference.

Art. 2 Formation and purpose of the contract

2.1. Jacuzzi Europe S.p.A. is committed to each order only after its acceptance in writing. Acceptance of the order by Jacuzzi Europe S.p.A. can also lead to its execution.

Art. 3 Delivery

3.1. Except for other written agreement, delivery is "Ex-works" Valvasone (Pn) – Italy. If the purchaser (retailer) does not provide for collection of goods, Jacuzzi Europe S.p.A. will have the right to entrust a reliable carrier with transport. In the event of non-collection the purchaser (retailer) will be bound to pay stock expenses.

3.2. The delivery terms agreed are indicative. In the event of delays, the purchaser (retailer), therefore, will not be able to forward any claim for compensation for damages.

Art. 4 Packaging

4.1. The packaging of appliances conforms to international transport norms carried out by land using motor vehicles. Non-standard packaging will entail an extra charge and will be agreed at the time of order.

Art. 5 Cancellation of orders

5.1. The purchaser's (retailer's) order constitutes a firm purchasing proposal. No order can be cancelled without the written consent of Jacuzzi Europe S.p.A. In the event of cancellation of orders, Jacuzzi Europe S.p.A. also reserves the right to demand compensation for damages.

Art. 6 Design – Technical data

6.1. Jacuzzi Europe S.p.A. reserves the right to stop, without warning, the manufacture of any model and to alter models during production, with no obligation to carry out the same modifications to previously sold products.

6.2. The data and features in the Jacuzzi Europe S.p.A. technical and publicity documentation (catalogues, handbooks, publicity brochures, illustrations, price lists) are subject to modifications and are not binding.

6.3 All costs and charges for the translation of the instructions manuals into the official language of the country of use of the products, shall be borne by the purchaser (retailer), who shall be solely responsible for the conformity of the translation with the original text provided by Jacuzzi Europe S.p.A.

6.4 The products supplied to the purchaser (retailer) are manufactured and marketed in accordance with the regulations in force in the EU as stated in the product declarations. The purchaser (retailer) is the sole responsible of the compliance with all applicable laws, standards and codes of the products imported in the purchaser's (retailer's) country.

Art. 7 Prices

7.1. Prices, excluding VAT, are those stated on the price lists in force at the time of ordering and refer to goods with delivery "Ex- works" Valvasone (Pn) – Italy, unless otherwise agreed.

7.2. Prices, quotations and discounts are subject to variation without the obligation of forewarning on the part of Jacuzzi Europe S.p.A.

7.3. All orders received after modification of price lists, as well as planned consignments after thirty days from notification of the variation, are subject to the new prices.

Art. 8 Payment

8.1. Payment of goods is considered validly made only when Jacuzzi Europe S.p.A. has been credited with the relative amounts.

8.2. Any delay or irregularity in payment gives Jacuzzi Europe S.p.A. the right to suspend supplies or to annul current contracts, even if they do not pertain to the payments in question, and also the right to compensation for any damage (including that related to currency devaluation). Jacuzzi Europe S.p.A. has the right in each case – starting from the expiry date of payment, without the need of a default action – to legal interest, which will be increased by 5 (five) points.

8.3. The purchaser (retailer) is bound to full payment also in the event of dispute or controversy. Compensation with possible credit claims from Jacuzzi Europe S.p.A. is not permitted without written authorization.

8.4. In the event of non-payment, even if only partial, Jacuzzi Europe S.p.A. has the right – at its discretion – to demand from the purchaser (retailer) payment of the full sum stated in the contract or to declare the contract null and void, with the right to obtain the return of the delivered goods and to withhold, as compensation for damages, the amounts collected up to that moment, except for any other action for greater damage.

Art. 9 Property reservation

9.1. In the event that full or part payment must be made after delivery, the delivered products remain the property of Jacuzzi Europe S.p.A. until the moment of full payment of the price, according to the provisions of art. 1523 of the Civil Code.

9.2. As provided by the aforesaid property reservation, Jacuzzi Europe S.p.A. will have the right to proceed with the collection of any unpaid goods; in which case all related costs will be at the expense of the purchaser (retailer) and Jacuzzi Europe S.p.A. will be able to withhold any amounts already collected as compensation for damage. If the purchaser (retailer) has resold the goods to third parties, the rights laid claim to by Jacuzzi Europe S.p.A., as provided in the present clause, will refer to the price obtained from the sale of the same goods.

Art. 10 Circumstances beyond control and excessive onerousness

10.1. Events constituting cases of exemption from responsibility are fires, collapse, floods, non-delivery of supplies, transport difficulties, strikes, closures or other events due to circumstances beyond control, which impede or considerably reduce production by Jacuzzi Europe S.p.A. or its suppliers, or seriously hinder transport of the sold goods. Annulment of the contract and also the provision of other solutions that are different from the claim for compensation for damages, are only permitted for impediments that continue for at least 60 days.

10.2. If the fulfillment of obligations, before their execution, by Jacuzzi Europe S.p.A. is considered excessively onerous, for any unexpected reason by a trader with normal experience in this sector – with regard to the original agreement thus altering the ratio itself by 20% or more – Jacuzzi Europe S.p.A. will be able to request a review of contractual terms or, in the event of non-agreement, declare the contract null and void.

Art. 11 Claims

11.1. The purchaser (retailer) is bound to declare any damage to the product, or non-conformity in delivery that could be discovered when in possession of the goods, in specific detail in writing otherwise the claim will be null and void. This must be within and no more than 8 days from the time the goods were made available.

11.2. Any defects in conformity that are not identified following a check of the goods as in paragraph 11.1 must be declared by the purchaser, or will be null and void, not later than the time provided by law. This starts from the moment the goods themselves were made available to the purchaser.

Art. 12 Warranty

12.1. In accordance with the contents of its Conventional Warranty Conditions, Jacuzzi Europe S.p.A. guarantees, all "Jacuzzi™" branded products or those marketed by Jacuzzi Europe S.p.A. through the network of Jacuzzi® branded distributors (hereafter the "Products") purchased, installed and used within the countries of the European Union for domestic purposes, unrelated to the business/professional activity carried out by the consumer, against conformity defects.

The Conventional Warranty applies only in the European Union country in which the purchase of the Products by the retailer is made (hereinafter the "Country of Purchase"). Products installed in a country other than the country of purchase are not covered by the Conventional Warranty.

For products purchased or used outside the European Union, the burden of the warranty and the consequent interventions necessary to eliminate any lack of conformity of the equipment will be at the full and exclusive expense of the purchaser (retailer), that shall therefore set up its own technical assistance organisation, unless otherwise agreed in writing with Jacuzzi Europe S.p.A.

Moreover, the Conventional Warranty does not apply if the regulations of the country of purchase require the Products also, to comply with different and/or more restrictive regulatory requirements than those prescribed by EU regulations and can be applied only on condition that Jacuzzi Europe S.p.A. has an authorised technical service centre in the "Country of purchase".

The warranty, which starts from the date of delivery of the product to the end user, is intended to be valid only upon payment of the total price of the equipment, provided that the intervention is carried out by Jacuzzi Europe S.p.A. authorised technicians and is valid for a period of: a) twelve (12) months, for products exhibited in commercial premises, trade fairs, showrooms or other commercial/promotional events, with the exception of damage caused directly and/or indirectly to the product by its prolonged exposure or by its transportation/dismantling/reassembly from one place of exhibition to another; b) twenty-four (24) months, for products other than those indicated in paragraph a). This warranty does not cover products the production of which has been discontinued for longer than twenty-four (24) months or which have become obsolete, meaning products from Jacuzzi Europe S.p.A. purchased more than sixty (60) months after the date of manufacture. Jacuzzi Europe S.p.A. reserves the right to verify whether the product is covered by this warranty.

12.2. The warranty is only valid if the installation and connection of the product to the electricity and water networks were performed by meticulously following the instructions and provisions contained in the Jacuzzi Europe S.p.A. user instruction manual and/or other equivalent documentation which includes product installation, usage and maintenance instructions, (hereinafter, "Jacuzzi Documentation"). If the product is located in sites which are difficult to reach on ordinary roads (e.g. in mountain areas or on minor islands), or if it was installed in a site which is not easily accessible and/or was installed in combination with premium materials, all costs (labour and material costs, including disassembly/reassembly, removal and relocation of the product and its components) shall be borne entirely by the purchaser (retailer), where responsible, or by the consumer; in no case shall Jacuzzi Europe S.p.A. be liable for such additional costs. The warranty expires if the product components or other parts are modified with respect to their original supply conditions.

12.3. The equipment shall not be replaced, either totally or partially (with the same product or with another product having similar characteristics) if this is objectively impossible or excessively expensive compared to the repair, or if it involves unreasonable expenses for Jacuzzi Europe S.p.A. compared to its repair, taking into account the value that the product would have if it were free from manufacturing defect, the extent of the defect, the possibility that the alternative remedy can be implemented without significant inconvenience to the end user. If during the period of validity of this warranty, the authorised technical personnel of Jacuzzi Europe S.p.A. ascertains a manufacturing defect of the product existing at the time of delivery and Jacuzzi Europe S.p.A. authorises return in advance, the latter will refund the buyer (retailer) the price of the product, as indicated in the sales invoice issued to the latter by Jacuzzi Europe S.p.A.

12.4. The warranty applies exclusively to non-conformities deriving from causes not attributable to Jacuzzi Europe S.p.A., such as, for example: incorrect periodic product maintenance and/or lack of diligence in performing the same; improper use of the product or which does not conform to the instructions in the Jacuzzi Documentation or which are in violation of the technical and/or safety measures required in the country of use, the laws, regulations and customs applicable therein; wrong and/or incorrect connection and/or setting of the product parameters; use of non-original spare parts; transport damages not reported within the legal terms or caused by transporters not authorised by Jacuzzi Europe S.p.A.; inefficiencies or anomalies of electrical or water systems; malfunctioning due to interference, bad or no reception of radio-frequency signals; malfunctioning of the product or parts of it caused by the use of different temperatures or pressures from those detailed in the Jacuzzi Documentation; anomalies of any kind not attributable to product manufacturing defects.

12.5. During the period of validity of this warranty, the network of Jacuzzi Europe S.p.A. Service Centres is authorised by the purchaser (retailer) to provide the warranty to the end user, even if the request is received from the user directly or via an intermediary. It is however understood that the purchaser (retailer) is directly responsible towards the end user for ascertained lack of product conformity, as required by law. The warranty is void if the end user or a delegate thereof does not allow the authorised Jacuzzi Europe S.p.A. technical personnel to perform any reasonable conformity and/or functional verification of the product, or if the products replaced under warranty are not returned to Jacuzzi Europe S.p.A.

12.6. The following are also not covered by the warranty: damages due to non-use of the product; loss of profits and damages of any kind, indirect and consequential; damages caused by the use of non-original Jacuzzi Europe S.p.A. accessories, consumables and parts subject to normal wear and usage due to the use or non-use of the product; damages caused by exceptional atmospheric phenomena or, nonetheless, not due to the normal product functioning; damages caused by water type or impurities in the water or from use of unsuitable and/or non-compliant with the requirements of the Jacuzzi Documentation.

12.7. Performance in accordance with the obligations under this warranty does not extend the original warranty period. In any case, this is without prejudice to the mandatory legal rights of the end user (consumer). This warranty cannot be suspended or prolonged as a result of non-use of the product. Jacuzzi Europe S.p.A. declines all liability for any damage that may be caused, directly or indirectly, to people, properties and animals, due to the failure to comply with all the instructions given in the Jacuzzi Documentation and if the regulations of the country of purchase require that the Products must comply with different and/or more restrictive regulatory requirements than those prescribed by the EU regulations as per point 12.1.

12.8. Under penalty of forfeiture of this warranty, the buyer (reseller) is not allowed to store the products for more than twenty-four (24) months from the date of delivery of the product to the latter. Jacuzzi Europe S.p.A. reserves the right to exercise the right of recourse against the purchaser (retailer) for any services due and made under warranty to the end user on such equipment, with full charge of any and all charges relating thereto.

Art. 13 Return of goods

13.1. The return of any materials must be previously authorized by Jacuzzi Europe S.p.A. in writing. Only products with their original packaging can be returned which have not yet been used, and whose model is still being produced and that were delivered not more than 12 months ago.

13.2. Products, which are not in the catalogue, that have been made according to specifications from the purchaser (retailer) will not be returned.

13.3. The cost of returning goods, to be borne by the purchaser (retailer) who will be charged for re-storage, will be a sum not exceeding 25% of the value of the returned goods.

Art. 14 Ethical Code – Model 231

14.1. In application of the provisions contained in Legislative Decree 231/2001 regarding the administrative liability Jacuzzi has adopted the Organization, Management and Control Model (hereinafter, "Model 231"). The Model 231 intends to formalize the principles, rules and procedures applied by Jacuzzi Europe S.p.A. in order to prevent illegal conduct from Directors, employees and third parties in the performance of their respective activities.

The general part of Model 231 and the Jacuzzi Ethics Code can be consulted on the website <https://www.jacuzzi.com/it-it/>. Considering the above, the purchaser (retailer) accepts to ensure that its directors, employees and / or consultants do not commit any of the offenses provided in Legislative Decree 231/2001 and to respect the provisions contained in the Code of Ethics and in the 231 Model. The purchaser (retailer) expressly acknowledges that the non-compliance or incorrect compliance with the obligations provided for by him under this provision, constitutes serious and inexcusable non-fulfillment, with the consequence that, upon the occurrence of this hypothesis, Jacuzzi Europe S.p.A. will have the right to terminate the contractual relationship due to the fact and fault of the purchaser (retailer). Furthermore, the purchaser (retailer) agrees to promptly inform Jacuzzi in writing, to the attention of the Supervisory Board (odv@jacuzzi.eu), of any violation of Legislative Decree 231/2001, in the context the execution of the negotiation relationship, which may, even if only potentially, imply the involvement of Jacuzzi Europe S.p.A.

Art. 15 Interpretation – Modifications

15.1. Any reference to Jacuzzi Europe S.p.A. price lists, general terms or other materials refers to the documents in force at the time of the same reference, unless otherwise specified.

15.2. Except for cases provided for under the current general terms, any modification carried out by parties to the contracts to which the current general terms apply must be in writing, or will be null and void. The exception to one or more provisions of the current general terms must not be interpreted extensively, or by analogy, and does not mean the general terms, as a whole, will cease to apply.

Art. 16 Controversies



16.1. For any controversy related, or connected, to the contracts to which the current terms are applied the Court of Pordenone has exclusive jurisdiction, also in the event of payment being agreed by means of bills of exchange.



NOTE

A series of horizontal lines spanning the width of the page, intended for handwritten notes.

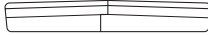
INSULATING COVER WÄRMEABDECKUNG

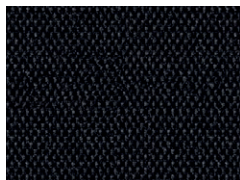
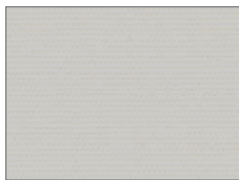
Collection Kollektion	J-400™ - J-LX® - J-300™ - J-200™ Classic - SWIM SPA	DESIGN - PROFESSIONAL - LODGE+
Typology Typologie	PROLAST™	PROVINYL
Feature	<p>Premium outdoor cover - 25% lighter. Water resistant. Superior UV resistance properties.</p> <p>Engineered for durability from superior marine-grade material, Jacuzzi® PROLAST™ Covers are 25% lighter for easier handling and add a premium touch to your outdoor decor.</p>	<p>Premium outdoor cover. Water resistant. Superior UV resistance properties.</p> <p>Engineered for durability from superior marine-grade material, Jacuzzi® Covers are easy to handle and add a premium touch to your outdoor decor.</p>
Feature	<p>Premium Außenhülle - 25 % leichter. Wasserdicht. Überlegene UV-Beständigkeitseigenschaften.</p> <p>Diese Planen wurden für beste Haltbarkeit aus einem hochwertigen Material aus dem maritimen Einsatzbereich entwickelt. Die Abdeckungen ProLast™ Jacuzzi® sind um 25% leichter, sie sind daher leichter zu handhaben und geben Ihrem Außenbereich einen hochwertigen Touch.</p>	<p>Premium Außenhülle - 25 % leichter. Wasserdicht. Überlegene UV-Beständigkeitseigenschaften.</p> <p>Die auf Langlebigkeit ausgelegten Jacuzzi®-Abdeckungen sind aus einem hochwertigen Material, das auch für maritime Anwendungen verwendet wird, sie sind einfach handzuhaben und verleihen Außenmöbeln einen Hauch von Klasse.</p>
Foam density Schaumdichte	~ 24 Kg/m ³	~ 24 Kg/m ³
Material	All-weather PROLAST™ Marine-grade fabric Marinestoff PROLAST™	Vinyl (PVC plasticized and polyester) Vinyl (Plastifiziertes PVC und Polyester)
Taper Schnittdarstellung	 <p>~ 100 - 65 mm</p>	 <p>~ 100 - 65 mm</p>
Cover handles Griffe	6 Exterior + 2 Interior 6 Exterior + 2 Interior	from 2 to 6 Exterior + 2 Interior von 2 bis 6 Exterior + 2 Interior
Color Farben	<p>J-400™ - J-LX® - J-300™ - J-200™ Classic</p>  <p>BLACK SCHWARZ</p>	<p>DESIGN - PROFESSIONAL</p>  <p>ICE</p>
	<p>SWIM SPA</p>  <p>GREY GRAU</p>	<p>LODGE+</p>  <p>GREY GRAU</p>

SEATS SITZE

Number of seats Anzahl der Sitze Lounge 	x 3	x 4	x 5	x 5-6	x 6	x 6-7	x 8-9
J-400™ COLLECTION				J-445™ J-435™		J-485™ J-475™	J-495™
J-LX® COLLECTION				J-LXL®		J-LX®	
J-300™ COLLECTION	J-315™		J-332™ J-325™	J-375™ J-355™ J-335™ J-332™ Dual Lounge™		J-385™ J-365™ J-345™	
J-200™ CLASSIC COLLECTION					J-235™ Classic		
DESIGN COLLECTION	Unique City™ Spa	Delos Delfi	Santorini	Alimia Profile		Virtus	
LODGE+ COLLECTION	Lodge+ S		Lodge+ M	Lodge+ L			
PROFESSIONAL COLLECTION				Enjoy Pro		Virginia Pro Alimia Pro Virtus Pro	Sienna Pro



DO NOT USE SEA WATER OR WATER WITH ADDED SALT ON ALL HOT TUB AND SWIM SPA MODELS.

IMAGES ARE PROVIDED BY WAY OF ILLUSTRATION ONLY. They are not binding on Jacuzzi Europe Spa, which reserves the right to make all changes considered appropriate with no need to provide prior notice or replacement.



ALLE HOT TUB- UND SWIM SPA-MODELLE NICHT MIT MEERWASSER ODER MIT ZUGESETZTEM SALZ VERWENDEN.

ALLE BILDER UND ABBILDUNGEN DIENEN NUR ILLUSTRATIVEN ZWECKEN. Sie sind nicht bindend für die Gesellschaft Jacuzzi Europe Spa, die sich das Recht vorbehält, alle als zweckmäßig erachteten Änderungen ohne jede Verpflichtung der Vorankündigung oder des Ersatzes vorzunehmen.

Jacuzzi®

JACUZZI EUROPE S.p.A.

Direzione e Coordinamento
Jacuzzi Brands, LLC. (USA)

S.S. Pontebbana km 97,200
33098 Valvasone Arzene (PN) Italia

Via dell'Unione, 1
20123 Milano (Italia)

Tel. +39 0434 859111
Fax +39 0434 85278

info@jacuzzi.eu
www.jacuzzi.com