



HOT TUB AND SWIM SPA

Price list
Listino prezzi

01.02.2020







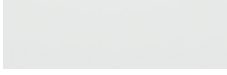

Euro V.A.T. not included
Euro I.V.A. esclusa

EN · IT







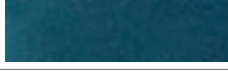
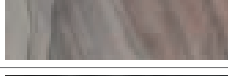
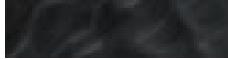























SPA COLOURS · COLORI

SPA

Check color availability by model
Controllare la disponibilità del colore per modello

			70	Desert Sand		All except J-300™ Tutti tranne J-300™
31	Porcelain					All except J-415™, J-315™ Tutti tranne J-415™, J-315™
32	Sandstone					All except J-495™ Tutti tranne J-495™
38	Carribean Surf					Except J-500™ collection and J-495™, J-485™, J-475™
49	Sahara					All except J-495™, J-415™ Tutti tranne J-495™, J-415™
52	Bianco White					
65	Platinum					All except City™ Spa Tutti tranne City™ Spa
			77	White Pearlescent		Only/solo Lodge
			84	Silver Pearl		
			85	Opal		All except J-495™ Only/solo J-495™
			97	Cobalt		Except City™ Spa, Unique, Lodge (all/ tutte)
			98	Monaco		All except J-495™, J-415™ Tutti tranne J-495™, J-415™
			99	Midnight		All except J-495™, J-415™ Tutti tranne J-495™, J-415™

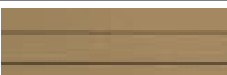
SKIRT (FINISHING) · PANNELLI (FINITURE)

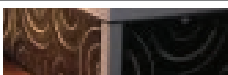

	Curvalux™ Silverwood		J-500™		Synthetic Graphite		DESIGN COLLECTION Virtus™, Virtus™ Pro, Profile, City™ Spa, Delfi, Delos and Santorini Pro range only
	Curvalux™ Roasted Chestnut		J-500™		Wood Wengè		DESIGN COLLECTION Unique only/solo
	Pro-Finish™ Brushed Gray		J-400™ and J-300™ only/solo		Wood Teak		DESIGN COLLECTION Unique only/solo
	Pro-Finish™ Modern Hardwood		J-400™ and J-300™ only/solo		Wood Teak		DESIGN COLLECTION Profile only/solo
	Pro-Finish™ Smoked Ebony		J-400™ and J-300™ only/solo		Wood Teak		DESIGN COLLECTION Virtus™, Virtus™ Pro, Profile, City™ Spa, Delfi, Delos and Santorini Pro range only
	Synthetic Wood Silverwood		Lodge		Wood Veined Oak		DESIGN COLLECTION City™ Spa, Delfi, Delos, and Santorini Pro range only/solo
	Synthetic Wood Roasted Chestnut		Lodge		Wood Sasha		DESIGN COLLECTION City™ Spa only/solo
	Synthetic Sahara		DESIGN COLLECTION City™ Spa and Unique only/solo		Customisable Panels		DESIGN COLLECTION Virtus™, City™ Spa and Unique only/solo

COVER INSULATING · COPERTURE TERMICHE

	Prolast™ Prolast™ Extreme Gray		J-500™, J-400™ e J-300™		Marine grade fabric Tessuto nautico		Virtus e Virtus Pro
	Prolast™ Prolast™ Extreme Black		On demand/su richiesta J-500™, J-400™ e J-300™		Standard Vinyl Platin		Italian Design
	Prolast™ Prolast™ Extreme Sienna		J-500™ on demand/su richiesta J-400™ e J-300™		Fabric Ice Sunbed		Unique
	Standard Vinyl Silverwood		Lodge e Profile Pro				
	Standard Vinyl Bordeaux		J-LXL				

SWIM SPA COLOURS · COLORI







SWIM SPA

Silver Pearl		Porcelain	
Platinum			

SWIM SPA: SKIRT (FINISHING) · PANNELLI (FINITURE)

 Silverwood/ Black		
--	---	--

SPA COVERS · COPERTURE

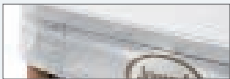
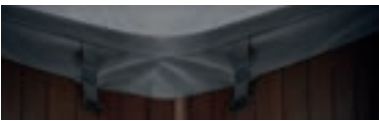
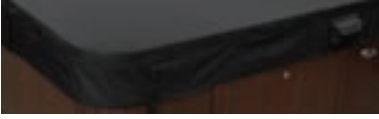
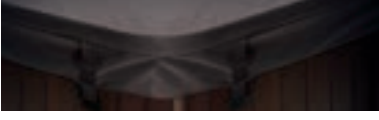
	STANDARD VINYL STANDARD IN VINILE	PROLAST™ COVERS COPERTURE PROLAST™	PROLAST™ EXTREME COVERS COPERTURE PROLAST™ EXTREME
Feature Caratteristiche	Easily wipes clean - Water resistant Di facile pulizia - Resistenti all'acqua	Premium outdoor cover - 25% lighter - Water resistant - Superior UV resistance properties Copertura per esterni di alta qualità - 25% più leggera - Resistente all'acqua - Elevata resistenza agli UV	Premium outdoor covers for extreme climates - Water resistant - Superior UV resistance properties - Angled to promote run-off - Dense foam supports heavy snow loads Coperture per esterni di alta qualità per condizioni climatiche estreme - Resistenti all'acqua - Elevata resistenza agli UV - Inclinate per favorire il deflusso - La schiuma compatta sostiene forti carichi di neve
Foam density Densità della schiuma	~ 24 Kg/m ³	~ 24 Kg/m ³	~ 32 Kg/m ³
Material Materiale	Vinyl Vinile	All-weather PROLAST™ Marine-grade fabric Tessuto nautico all-weather PROLAST™	All-weather PROLAST™ Marine-grade fabric Tessuto nautico all-weather PROLAST™
Taper Sezione	 ~ 100 - 65 mm	 ~ 100 - 65 mm	 ~ 125 - 75 mm
Cover handles Maniglie	2 Exterior 2 esterne	6 Exterior + 2 Interior 6 esterne + 2 interne	6 Exterior + 2 Interior 6 esterne + 2 interne
Size Dimensione	Custom ordered for any hot tub brand Ordine personalizzabile adattabile a tutte le spa	Custom ordered for any hot tub brand Ordine personalizzabile adattabile a tutte le spa	Custom ordered for any hot tub brand Ordine personalizzabile adattabile a tutte le spa
Colors Colori	 Silverwood  Bordeaux  Platin  Ice	 Grey  Black  Sienna	
	Standard covers offer basic protection, helping to maintain heat and keep debris out of your hot tub.	Engineered for durability from superior marinegrade material, Jacuzzi® PROLAST™ Covers are 25% lighter for easier handling and add a premium touch to your outdoor decor.	Jacuzzi® PROLAST™ EXTREME Covers are made from superior marine-grade material, offering the greatest weight-load bearing capacity, the highest density foam, and are pitched to encourage run-off of rain and snow.
	Le coperture standard offrono una protezione di base, aiutano a mantenere il calore e a tenere la sporcizia lontana dalla vostra spa.	Progettate per durare a lungo in un materiale di alta qualità utilizzato nel settore nautico, le coperture Jacuzzi® PROLAST™ sono il 25% più leggere, quindi più facili da maneggiare, e aggiungono un tocco di classe agli arredi esterni.	Le coperture JACUZZI® PROLAST™ EXTREME sono realizzate in un materiale di alta qualità utilizzato nel settore nautico: offrono la maggiore capacità di carico, una schiuma di densità estremamente elevata, e sono inclinate per favorire il deflusso di pioggia e neve.

PROLAST™ cover additional cost +150€
PROLAST™ EXTREME cover additional cost +250€
 For orders and availability please contact our Customer Care.

PROLAST™ cover prezzo aggiuntivo +150€
PROLAST™ EXTREME cover prezzo aggiuntivo +250€
 Per ordini e disponibilità contattare la sede.

INDEX • INDICE

SmartTub™	new	3
-----------	------------	---

J-500™ - J-400™ - J-LX® - J-300™		
Instructions for ordering Come ordinare		4

THE J-500™ LUXURY COLLECTION		
J-585™		6
J-575™		7

THE J-400™ DESIGNER COLLECTION		
J-495™	new	9
J-485™		10
J-475™		11
J-445™		12
J-435™		13
J-425™	new	14
J-415™		15

THE J-300™ COMFORT COLLECTION		
J-385™	new	18
J-375™	new	19
J-365™	new	20
J-355™	new	21
J-345™	new	22
J-335™	new	23
J-325™	new	24
J-315™	new	25

THE J-LX® ENERGY EFFICIENT COLLECTION		
J-LXL®		27

THE DESIGN COLLECTION		
VIRTUS		31
PROFILE		32
FLOW		33
CITY™ SPA		34
DELFI		35
DELFI PRO		36
DELFI PRO SOUND		37
DELOS		38
DELOS PRO		39
DELOS PRO SOUND		40
SANTORINI PRO		41
SANTORINI PRO SOUND		42
UNIQUE		43
ALIMIA		44
OXIA		45

THE LODGE COLLECTION		
LODGE S		49
LODGE M		50
LODGE L	new	51

THE PROFESSIONAL COLLECTION		
VIRTUS PRO		54
PROFILE PRO		55
ENJOY		56
VIRGINIA EXPERIENCE		57
SIENNA EXPERIENCE		58
ALIMIA EXPERIENCE		59

THE SWIM SPA COLLECTION		
POWERPRO™ J-19		62
POWERPRO™ J-16		63
POWERACTIVE™ J-19		64
POWERACTIVE™ J-16		65

Accessories Swim Spa Accessori Swim Spa		66
--	--	----

Outdoor shower column Colonna doccia per esterno		67
---	--	----

Accessories Spa Accessori Spa		68
----------------------------------	--	----

Insulating cover Coperture termiche		70
--	--	----

General terms of sale Condizioni generali di vendita		72
---	--	----

SmartTub™

SIMPLIFIED HOT TUB OWNERSHIP

Patented and exclusive technology focused on providing the absolute best consumer hot tub ownership experience.

- Stable, secure, cellular connection
- Easy setup, no WiFi credential needed
- Updates made seamlessly over the air
- System learns based on use
- Includes 1 year data plan, \$36/yr after*
- Remote monitoring and alerts
- Reminders
- Power outage notification
- Energy usage estimator**
- Personalized use and care content

• Compatible with Android, iOS, Alexa, iPad, Apple Watch and Google Assistant



Learn more about SmartTub™ Technology by visiting www.jacuzzi.eu

COMUNICARE CON LA PROPRIA SPA È PIÙ FACILE

La tecnologia brevettata Jacuzzi® per permetterti il miglior utilizzo della tua SPA.

- Connessione cellulare sicura e stabile
- Setup facile, nessuna credenziale WiFi necessaria
- Aggiornamenti continui
- Il sistema si aggiorna in automatico
- Include piano dati per 1 anno, dal secondo anno \$36*
- Monitoraggio remoto e avvisi personalizzati
- Promemoria
- Avviso in caso di mancanza di corrente
- Stime dei consumi energetici **
- Contenuti personalizzati per l'utilizzo e la manutenzione

• Compatibile con Android, iOS, Alexa, iPad, Apple Watch e Google Assistant

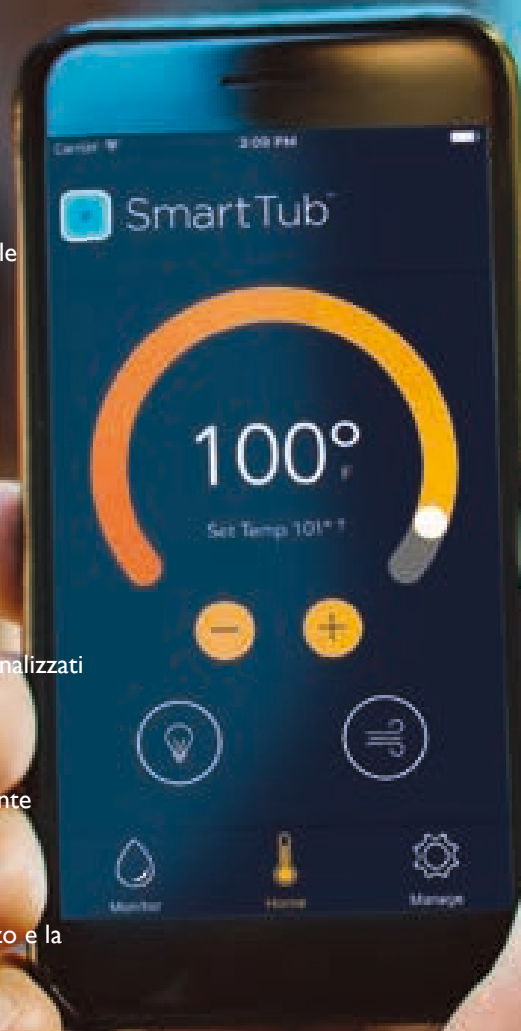

Per saperne di più su SmartTub™ Technology consultare www.jacuzzi.eu

SmartTub™ system uses cellular-based communication and requires cell service from our provider partner in your area. See website for details.

* Requires subscription beginning in second year of ownership.

** Estimates are based on sensor readings and are not meant to match your utility measurements, see your local utility company for specifics.

Il sistema SmartTub™ utilizza la comunicazione su base cellulare e richiede la copertura della linea telefonica del nostro fornitore partner nella vostra zona. Vedere il sito web per i dettagli.

* È richiesto l'abbonamento a partire dal secondo anno.

** Le stime si basano sulle rilevazioni dei sensori e non corrispondono alle letture delle utenze, consultare la propria società di servizi pubblici locali per maggiori informazioni.



INSTRUCTIONS FOR ORDERING

Dimensions and descriptions are indicated in the master brochure and in this price list.

Orders must include:

- a) name
- b) hot tub code
- c) colour code
(replace the asterisk with the reference number of the chosen colour)

I.e.

SPA: J-585™ SILVERWOOD
Colour: Desert Sand
Bluewave™ Stereo System (Wireless + AUX)

- J-585 944626770

COME ORDINARE

Per la descrizione e dimensioni, riferirsi al catalogo ed al prospetto del listino.

Gli ordini devono includere:

- a) nome
- b) codice spa
- c) codice colore
(al posto dell'asterisco mettere il riferimento numerico del colore prescelto)

Es.

SPA: J-585™ SILVERWOOD
Colore: Desert Sand
Bluewave™ Stereo System (Wireless + AUX)

- J-585 944626770



THE J-500™ LUXURY COLLECTION





J-585™ SmartTub™





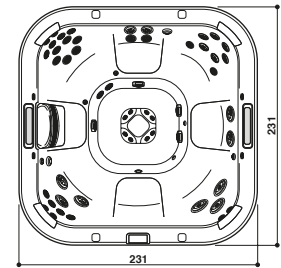





Design Jacuzzi®

231 x 231 x 92/107 H cm



FREESTANDING



FEATURES · DOTAZIONI

	Seats (total) Sedute (totali)	6-7
	PowerPro® Jets Bocchette PowerPro®	46
	Waterfall with lights Cascata con luci	2
	ProEdge™ interior lighting Illuminazione interna ProEdge™	✓
	External corner lighting Illuminazione esterna angolare	✓
	Pillow headrest Poggiatesta	4
	ProTouch™ control panel Pannello di controllo ProTouch™	✓
	Quick drain Svuotamento rapido	✓
	Water monitoring system Sistema di monitoraggio acqua	✓
	CLEARRAY® PRO ₃ TECT™ UV-C + Low output ozone generator UV-C + Ozonizzatore a bassa emissione	✓



COLOURS · COLORI

31 32 49 65 70 84 85 98 99

SKIRTING · PANNELLI

		Curvalux™	SILVERWOOD	ROASTED CHESTNUT
	Insulating cover Copertura termica	ProLast™	GREY	SIENNA
	Bluewave™ Stereo System (Wireless + AUX)		9446267*	9446268*
			€ 29.720	
	Without Stereo System Senza Stereo System		9446269*	9446270*
			€ 27.018	

ACCESSORIES · ACCESSORI

		Curvalux™	SILVERWOOD	ROASTED CHESTNUT
	J-500™ Step Gradino		890010830	890010840
			€ 932	
	J-500™ Covermate by hand Sollevatore manuale per copertura termica		890010770	
			€ 848	

* **COVER OPTIONS ProLast™: Black, Sienna - ProLast Extreme™: Black, Grey, Sienna, - Vinyl: Silverwood, Bordeaux.** For orders and availability please contact our Customer Care.

* **OPZIONI COPERTURA ProLast™: Black, Sienna - ProLast Extreme™: Black, Grey, Sienna, - Vinyl: Silverwood, Bordeaux.** Per ordini e disponibilità contattare la sede.



J-575™ SmartTub™

Design Jacuzzi®



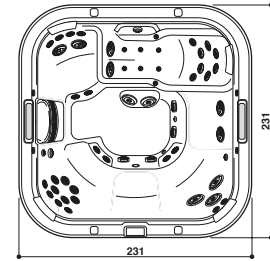







231 x 231 x 92/107 H cm



FEATURES · DOTAZIONI





FREESTANDING

	Seats (total) Sedute (totali)	5-6
	Lounge	1
	PowerPro® jets Bocchette PowerPro®	49
	Waterfall with lights Cascata con luci	2
	ProEdge™ interior lighting Illuminazione interna ProEdge™	✓
	External corner lighting Illuminazione esterna angolare	✓
	Pillow headrest Poggiatesta	4
	ProTouch™ control panel Pannello di controllo ProTouch™	✓
	Quick drain Svuotamento rapido	✓
	Water monitoring system Sistema di monitoraggio acqua	✓
	CLEARRAY® PRO ₃ TECT™ UV-C + Low output ozone generator UV-C + Ozonizzatore a bassa emissione	✓



COLOURS · COLORI

31 32 49 65 70 84 85 98 99

SKIRTING · PANNELLI

		Curvlux™	SILVERWOOD	ROASTED CHESTNUT
	Insulating cover Copertura termica	ProLast™	GREY	SIENNA
	Bluewave™ Stereo System (Wireless + AUX)		9446263*	9446264*
			€ 29.720	
	Without Stereo System Senza Stereo System		9446265*	9446266*
			€ 27.018	

ACCESSORIES · ACCESSORI

		Curvlux™	SILVERWOOD	ROASTED CHESTNUT
	J-500™ Step Gradino		890010830	890010840
			€ 932	
	J-500™ Covermate by hand Sollevatore manuale per copertura termica		890010770	
			€ 848	

* **COVER OPTIONS ProLast™: Black, Sienna - ProLast Extreme™: Black, Grey, Sienna, - Vinyl: Silverwood, Bordeaux.** For orders and availability please contact our Customer Care.

* **OPZIONI COPERTURA ProLast™: Black, Sienna - ProLast Extreme™: Black, Grey, Sienna, - Vinyl: Silverwood, Bordeaux.** Per ordini e disponibilità contattare la sede.



THE J-400™ DESIGNER COLLECTION

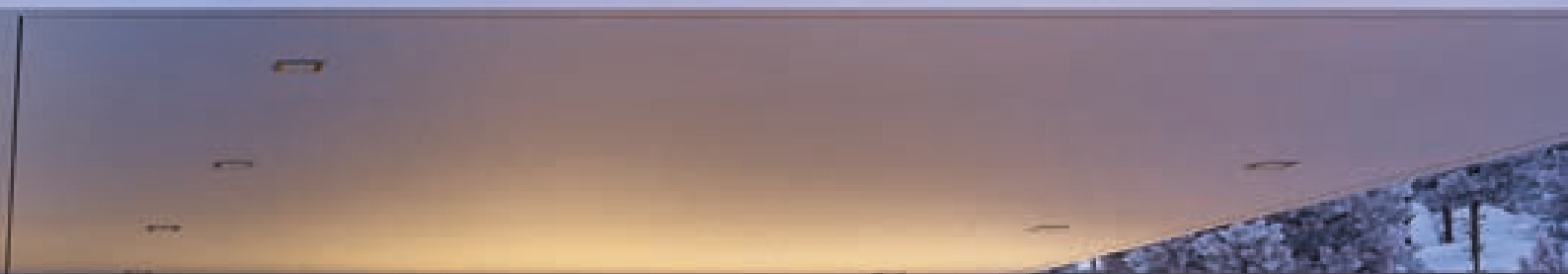
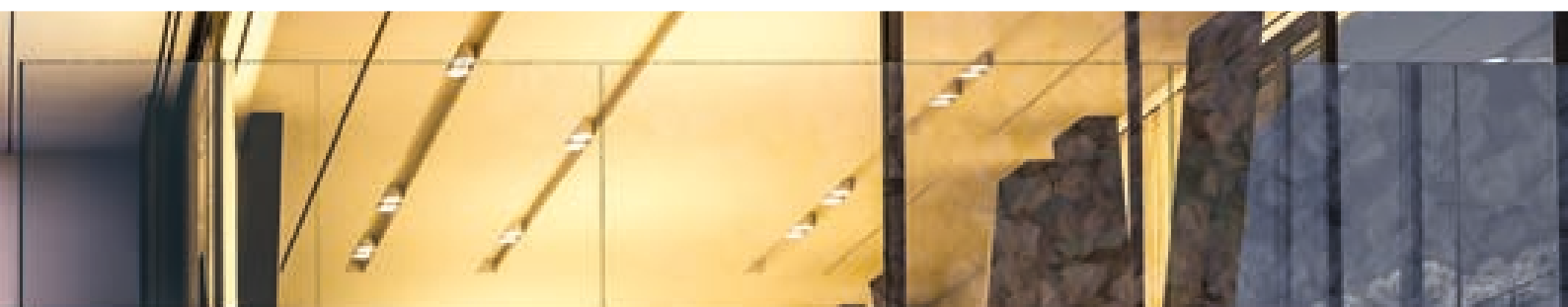



J-495™ SmartTub™
Design Jacuzzi®

new

231 x 279 x 95/110 H cm

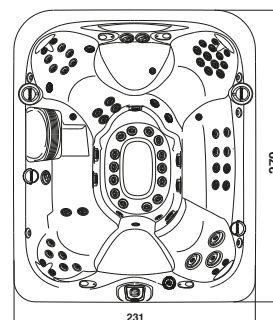

FEATURES · DOTAZIONI



FREESTANDING

	Seats (total) Sedute (totali)	8 - 9
	Lounge	1 pivot
	PowerPro® Jets Bocchette PowerPro®	71
	WaterColour™ Waterfall Cascata WaterColour™	1
	Light System LED Multicolor Luci LED Multicolour	✓
	Adjustable pillow headrest Poggiatesta regolabile	4
	ProTouch™ control panel Pannello di controllo ProTouch™	✓
	External corner lighting Illuminazione esterna angolare	✓
	Status indicator light Indicatore di funzionamento	✓
	CLEARRAY® PRO ₃ TECT™ UV-C + Low output ozone generator UV-C + Ozonizzatore a bassa emissione	✓
	Quick drain Svuotamento rapido	✓

COLOURS · COLORI

31 49 65 70 84 98 99

SKIRTING · PANNELLI

		ProFinish™	BRUSHED GREY	MODERN HARDWOOD	SMOKED EBONY
	Insulating cover Copertura termica	ProLast™	GREY		
	Bluewave™ Stereo System (Wireless + AUX)		9445573*	9445572*	9445574*
			€ 29.941		
	Without Stereo System Senza Stereo System		9445570*	9445569*	9445571*
			€ 27.250		

ACCESSORIES · ACCESSORI

		ProFinish™	BRUSHED GREY	MODERN HARDWOOD	SMOKED EBONY
	J-400™ Step Gradino		890011190	890011170	890011180
			€ 605		
	J-400™ Covermate with pistons Sollevatore con pistoni per copertura termica		890010710		
			€ 803		

* COVER OPTIONS ProLast™: Black, Sienna - ProLast Extreme™: Black, Grey, Sienna, - Vinyl: Silverwood, Bordeaux. For orders and availability please contact our Customer Care.

* OPZIONI COPERTURA ProLast™: Black, Sienna - ProLast Extreme™: Black, Grey, Sienna, - Vinyl: Silverwood, Bordeaux. Per ordini e disponibilità contattare la sede.



J-485™ SmartTub™

Design Jacuzzi®



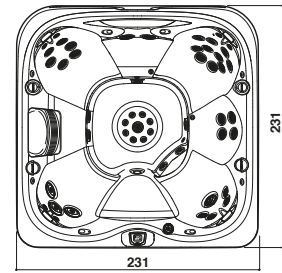







231 x 231 x 95/110 H cm



FEATURES · DOTAZIONI







FREESTANDING

	Seats (total) Sedute (totali)	6-7
	PowerPro® Jets Bocchette PowerPro®	49
	WaterColour™ Waterfall Cascata WaterColour™	1
	Light System LED Multicolor Luci LED Multicolour	✓
	Adjustable pillow headrest Poggiatesta regolabile	4
	ProTouch™ control panel Pannello di controllo ProTouch™	✓
	External corner lighting Illuminazione esterna angolare	✓
	Status indicator light Indicatore di funzionamento	✓
	CLEARRAY® PRO ₃ TECT™ UV-C + Low output ozone generator UV-C + Ozonizzatore a bassa emissione	✓
	Quick drain Svuotamento rapido	✓



COLOURS · COLORI

31 32 49 65 70 84 85 98 99

SKIRTING · PANNELLI

		ProFinish™	BRUSHED GREY	MODERN HARDWOOD	SMOKED EBONY
	Insulating cover Copertura termica	ProLast™	GREY		
	 Bluewave™ Stereo System (Wireless + AUX)		9445506*	9445505*	9445504*
			€ 27.247		
	 Without Stereo System Senza Stereo System		9445509*	9445508*	9445507*
			€ 24.680		

ACCESSORIES · ACCESSORI

		ProFinish™	BRUSHED GREY	MODERN HARDWOOD	SMOKED EBONY
	J-400™ Step Gradino		890011190	890011170	890011180
			€ 605		
	J-400™ Covermate with pistons Sollevatore con pistoni per copertura termica		890011160		
			€ 699		

* **COVER OPTIONS ProLast™: Black, Sienna - ProLast Extreme™: Black, Grey, Sienna, - Vinyl: Silverwood, Bordeaux.** For orders and availability please contact our Customer Care.

* **OPZIONI COPERTURA ProLast™: Black, Sienna - ProLast Extreme™: Black, Grey, Sienna, - Vinyl: Silverwood, Bordeaux.** Per ordini e disponibilità contattare la sede.



J-475™ SmartTub™

Design Jacuzzi®



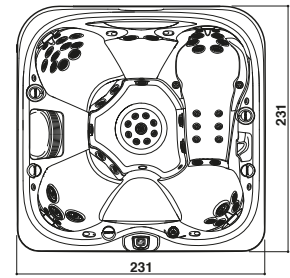







231 x 231 x 95/110 H cm



FEATURES · DOTAZIONI







FREESTANDING

	Seats (total) Sedute (totali)	6-7
	Lounge	I
	PowerPro® Jets Bocchette PowerPro®	55
	WaterColour™ Waterfall Cascata WaterColour™	I
	Light System LED Multicolor Luci LED Multicolour	✓
	Adjustable pillow headrest Poggiatesta regolabile	4
	ProTouch™ control panel Pannello di controllo ProTouch™	✓
	External corner lighting Illuminazione esterna angolare	✓
	Status indicator light Indicatore di funzionamento	✓
	CLEARRAY® PRO ₃ TECT™ UV-C + Low output ozone generator UV-C + Ozonizzatore a bassa emissione	✓
	Quick drain Svuotamento rapido	✓



COLOURS · COLORI

31 32 49 65 70 84 85 98 99

SKIRTING · PANNELLI

		ProFinish™	BRUSHED GREY	MODERN HARDWOOD	SMOKED EBONY
	Insulating cover Copertura termica	ProLast™	GREY		
	 Bluewave™ Stereo System (Wireless + AUX)		9445494*	9445493*	9445492*
				€ 27.247	
	 Without Stereo System Senza Stereo System		9445497*	9445496*	9445495*
				€ 24.680	

ACCESSORIES · ACCESSORI

		ProFinish™	BRUSHED GREY	MODERN HARDWOOD	SMOKED EBONY
	J-400™ Step Gradino		890011190	890011170	890011180
				€ 605	
	J-400™ Covermate with pistons Sollevatore con pistoni per copertura termica			890010710	
				€ 803	

* **COVER OPTIONS ProLast™: Black, Sienna - ProLast Extreme™: Black, Grey, Sienna, - Vinyl: Silverwood, Bordeaux.** For orders and availability please contact our Customer Care.

* **OPZIONI COPERTURA ProLast™: Black, Sienna - ProLast Extreme™: Black, Grey, Sienna, - Vinyl: Silverwood, Bordeaux.** Per ordini e disponibilità contattare la sede.



J-445™ SmartTub™

Design Jacuzzi®



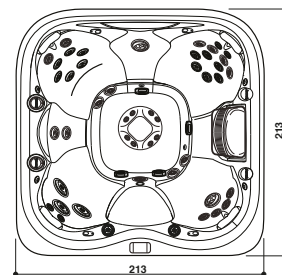







213 x 213 x 95/110 H cm



FEATURES · DOTAZIONI







FREESTANDING

	Seats (total) Sedute (totali)	6
	PowerPro® Jets Bocchette PowerPro®	45
	WaterColour™ Waterfall Cascata WaterColour™	1
	Light System LED Multicolor Luci LED Multicolour	✓
	Adjustable pillow headrest Poggiatesta regolabile	4
	ProTouch™ control panel Pannello di controllo ProTouch™	✓
	External corner lighting Illuminazione esterna angolare	✓
	Status indicator light Indicatore di funzionamento	✓
	CLEARRAY® PRO ₃ TECT™ UV-C + Low output ozone generator UV-C + Ozonizzatore a bassa emissione	✓
	Quick drain Svuotamento rapido	✓



COLOURS · COLORI

31 32 38 49 65 70 84 85 98 99

SKIRTING · PANNELLI

		ProFinish™	BRUSHED GREY	MODERN HARDWOOD	SMOKED EBONY
	Insulating cover Copertura termica	ProLast™	GREY		
	 SMART SEAL Bluewave™ Stereo System (Wireless + AUX)		9446440*	9446439*	9446441*
			€ 23.644		
	 SMART SEAL Without Stereo System Senza Stereo System		9446437*	9446436*	9446438*
			€ 21.306		

ACCESSORIES · ACCESSORI

		ProFinish™	BRUSHED GREY	MODERN HARDWOOD	SMOKED EBONY
	J-400™ Step Gradino		890011190	890011170	890011180
			€ 605		
	J-400™ Covermate with pistons Sollevatore con pistoni per copertura termica		890010710		
			€ 803		

* **COVER OPTIONS ProLast™: Black, Sienna - ProLast Extreme™: Black, Grey, Sienna, - Vinyl: Silverwood, Bordeaux.** For orders and availability please contact our Customer Care.

* **OPZIONI COPERTURA ProLast™: Black, Sienna - ProLast Extreme™: Black, Grey, Sienna, - Vinyl: Silverwood, Bordeaux.** Per ordini e disponibilità contattare la sede.



J-435™ SmartTub™





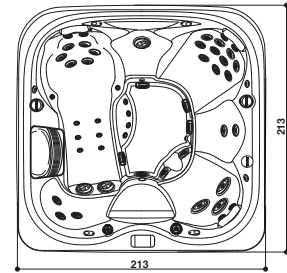



Design Jacuzzi®

213 x 213 x 95/110 H cm



FREESTANDING





FEATURES · DOTAZIONI

	Seats (total) Sedute (totali)	5-6
	Lounge	1
	PowerPro® Jets Bocchette PowerPro®	47
	WaterColour™ Waterfall Cascata WaterColour™	1
	Light System LED Multicolor Luci LED Multicolour	✓
	Adjustable pillow headrest Poggiatesta regolabile	3
	ProTouch™ control panel Pannello di controllo ProTouch™	✓
	External corner lighting Illuminazione esterna angolare	✓
	Status indicator light Indicatore di funzionamento	✓
	CLEARRAY® PRO ₃ TECT™ UV-C + Low output ozone generator UV-C + Ozonizzatore a bassa emissione	✓
	Quick drain Svuotamento rapido	✓



COLOURS · COLORI

31 32 38 49 65 70 84 85 98 99

SKIRTING · PANNELLI

		ProFinish™	BRUSHED GREY	MODERN HARDWOOD	SMOKED EBONY
	Insulating cover Copertura termica	ProLast™	GREY		
	 Bluewave™ Stereo System (Wireless + AUX)		9446428*	9446427*	9446429*
	 Without Stereo System Senza Stereo System		9446425*	9446424*	9446426*
				€ 23.644	
				€ 21.306	

ACCESSORIES · ACCESSORI

		ProFinish™	BRUSHED GREY	MODERN HARDWOOD	SMOKED EBONY
	J-400™ Step Gradino		890011190	890011170	890011180
				€ 605	
	J-400™ Covermate with pistons Sollevatore con pistoni per copertura termica			890010710	
				€ 803	

* COVER OPTIONS ProLast™: Black, Sienna - ProLast Extreme™: Black, Grey, Sienna, - Vinyl: Silverwood, Bordeaux. For orders and availability please contact our Customer Care.

* OPZIONI COPERTURA ProLast™: Black, Sienna - ProLast Extreme™: Black, Grey, Sienna, - Vinyl: Silverwood, Bordeaux. Per ordini e disponibilità contattare la sede.



J-425™ SmartTub™
Design Jacuzzi®

new

193 x 221 x 86/101 H cm

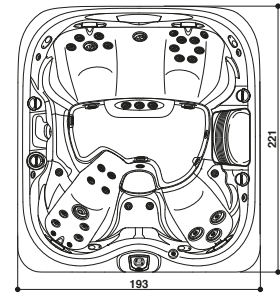

FREESTANDING

FEATURES · DOTAZIONI

	Seats (total) Sedute (totali)	4-5
	PowerPro® Jets Bocchette PowerPro®	35
	WaterColour™ Waterfall Cascata WaterColour™	1
	Light System LED Multicolor Luci LED Multicolour	✓
	Adjustable pillow headrest Poggiatesta regolabile	4
	ProTouch™ control panel Pannello di controllo ProTouch™	✓
	External corner lighting Illuminazione esterna angolare	✓
	Status indicator light Indicatore di funzionamento	✓
	CLEARRAY® PRO ₃ TECT™ UV-C + Low output ozone generator UV-C + Ozonizzatore a bassa emissione	✓
	Quick drain Svuotamento rapido	✓

COLOURS · COLORI

31 32 38 49 65 70 84 85 98 99

SKIRTING · PANNELLI

		ProFinish™	BRUSHED GREY	MODERN HARDWOOD	SMOKED EBONY
	Insulating cover Copertura termica	ProLast™	GREY		
	SMART SEAL Bluewave™ Stereo System (Wireless + AUX)		9446561*	9446562*	9446560*
			€ 20.600		
	SMART SEAL Without Stereo System Senza Stereo System		9446558*	9446559*	9446557*
			€ 18.265		

ACCESSORIES · ACCESSORI

		ProFinish™	BRUSHED GREY	MODERN HARDWOOD	SMOKED EBONY
	J-400™ Step Gradino		890011190	890011170	890011180
			€ 605		
	J-400™ Covermate with pistons Sollevatore con pistoni per copertura termica		890010710		
			€ 803		

* **COVER OPTIONS ProLast™: Black, Sienna - ProLast Extreme™: Black, Grey, Sienna, - Vinyl: Silverwood, Bordeaux.** For orders and availability please contact our Customer Care.

* **OPZIONI COPERTURA ProLast™: Black, Sienna - ProLast Extreme™: Black, Grey, Sienna, - Vinyl: Silverwood, Bordeaux.** Per ordini e disponibilità contattare la sede.



J-415™

Design Jacuzzi®

193 x 168 x 81 H cm

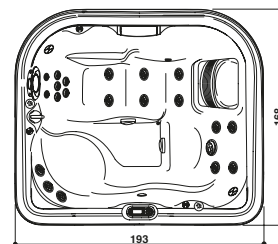

CAN BE ORDERED UNTIL 31TH MARCH 2020
ORDINABILE FINO AL 31 MARZO 2020

FEATURES · DOTAZIONI



FREESTANDING

	Seats (total) Sedute (totali)	2-3
	Lounge	I
	PowerPro® Jets Bocchette PowerPro®	20
	WaterColour™ Waterfall Cascata WaterColour™	I
	Light System LED Multicolor Luci LED Multicolour	✓
	Adjustable pillow headrest Poggiatesta regolabile	I
	ProTouch™ control panel Pannello di controllo ProTouch™	✓
	Smart Access Door Pannello "Smart Access"	✓
	CLEARRAY® PRO ₃ TECT™ UV-C + Low output ozone generator UV-C + Ozonizzatore a bassa emissione	✓

COLOURS · COLORI

31 32 38 49 65 70 84 85 98 99

SKIRTING · PANNELLI

		ProEndure™	BRAZILIAN TEAK	SILVERWOOD	ROASTED CHESTNUT
	Insulating cover Copertura termica	ProLast™	GREY		
	Bluewave™ Stereo System (Wireless + AUX)		9445344*	9445348*	9445352*
			€ 17.558		
	Without Stereo System Senza Stereo System		9445345*	9445349*	9445353*
			€ 15.107		

ACCESSORIES · ACCESSORI

		ProEndure™	BRAZILIAN TEAK	SILVERWOOD	ROASTED CHESTNUT
	J-400™ Step Gradino		890010600	890010590	890010640
			€ 737		
	J-400™ Covermate with pistons Sollevatore con pistoni per copertura termica		890010760		
			€ 482		

* COVER OPTIONS ProLast™: Black, Sienna - ProLast Extreme™: Black, Grey, Sienna, - Vinyl: Silverwood, Bordeaux. For orders and availability please contact our Customer Care.

* OPZIONI COPERTURA ProLast™: Black, Sienna - ProLast Extreme™: Black, Grey, Sienna, - Vinyl: Silverwood, Bordeaux. Per ordini e disponibilità contattare la sede.



new

THE J-300™ COMFORT COLLECTION





J-385™

Design Jacuzzi®

231 x 231 x 97 H cm

new

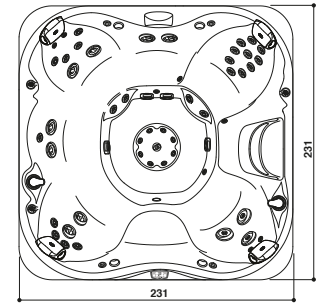

FREESTANDING

FEATURES · DOTAZIONI

	Seats (total) Sedute (totali)		6-7
	PowerPro® Jets Bocchette PowerPro®		51
	Waterfall with lights Cascata con luci		✓
	HydroSoothe™ cushion Cuscino HydroSoothe™		1
	Soft headrest Poggiatesta morbido		3
	Light System Multicolor Luci Multicolour		✓
	LED control panel Pannello comandi LED		✓
	External corner lighting Illuminazione esterna angolare		✓
	(1) Remote control Telecomando		✓
	CLEARRAY® PRO ₃ TECT™ UV-C + Low output ozone generator UV-C + Ozonizzatore a bassa emissione		✓
	SmartTub™	919405110 € 650	Optional

COLOURS · COLORI

31 32 38 49 65 70 84 85 98 99

SKIRTING · PANNELLI

	ProFinish™	BRUSHED GRAY	MODERN HARDWOOD	SMOKED EBONY
	(2) Insulating cover Copertura termica		GREY	
	Bluewave™ Stereo System	9445585*	9445584*	9445586*
			€ 21.363	
	Without Stereo System Senza Stereo System	9445582*	9445581*	9445583*
			€ 19.336	

ACCESSORIES · ACCESSORI

	ProFinish™	BRUSHED GRAY	MODERN HARDWOOD	SMOKED EBONY
	J-300™ Step Gradino	890011190	890011170	890011180
			€ 605	
	J-300™ Covermate by hand Sollevatore manuale per copertura termica		890010780	
			€ 506	
	J-300™ Covermate with pistons Sollevatore con pistoni per copertura termica		890011260	
			€ 699	

(1) The remote control is only available for versions provided with a stereo system

(1) Il telecomando è disponibile solo per le versioni con stereo.

(2) **COVER OPTIONS ProLast™: Black, Sienna - ProLast Extreme™: Black, Sienna, Grey - Vinyl: Silverwood, Bordeaux.** For orders and availability please contact our Customer Care.

(2) **OPZIONI COPERTURA ProLast™: Black, Sienna - ProLast Extreme™: Black, Sienna, Grey - Vinile: Silverwood, Bordeaux.** Per ordini e disponibilità contattare la sede.



J-375™

Design Jacuzzi®

new

231 x 231 x 97 H cm

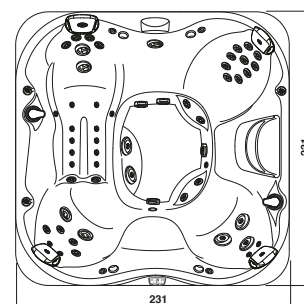

FREESTANDING

FEATURES · DOTAZIONI

	Seats (total) Sedute (totali)		5-6
	Lounge		1
	PowerPro® Jets Bocchette PowerPro®		52
	Waterfall with lights Cascata con luci		✓
	HydroSoothe™ cushion Cuscino HydroSoothe™		1
	Soft headrest Poggiatesta morbido		3
	Light System Multicolor Luci Multicolour		✓
	LED control panel Pannello comandi LED		✓
	External corner lighting Illuminazione esterna angolare		✓
	(1) Remote control Telecomando		✓
	CLEARRAY® PRO ₃ TECT™ UV-C + Low output ozone generator UV-C + Ozonizzatore a bassa emissione		✓
	SmartTub™	919405110 € 650	Optional

COLOURS · COLORI

		31	32	38	49	65	70	84	85	98	99
SKIRTING · PANNELLI	ProFinish™	BRUSHED GRAY		MODERN HARDWOOD				SMOKED EBONY			
	(2) Insulating cover Copertura termica	ProLast™									
	SMART SEAL Bluewave™ Stereo System	9445597*		9445596*				9445598*			
	SMART SEAL Without Stereo System Senza Stereo System	9445594*		9445593*				9445595*			
		€ 21.694		€ 19.649							

ACCESSORIES · ACCESSORI

		ProFinish™	BRUSHED GRAY	MODERN HARDWOOD	SMOKED EBONY
	J-300™ Step Gradino		890011190	890011170	890011180
			€ 605		
	J-300™ Covermate by hand Sollevatore manuale per copertura termica		890010780		
			€ 506		
	J-300™ Covermate with pistons Sollevatore con pistoni per copertura termica		890011260		
			€ 699		

(1) The remote control is only available for versions provided with a stereo system

(1) Il telecomando è disponibile solo per le versioni con stereo.

(2) **COVER OPTIONS ProLast™: Black, Sienna - ProLast Extreme™: Black, Sienna, Grey - Vinyl: Silverwood, Bordeaux.** For orders and availability please contact our Customer Care.

(2) **OPZIONI COPERTURA ProLast™: Black, Sienna - ProLast Extreme™: Black, Sienna, Grey - Vinyl: Silverwood, Bordeaux.** Per ordini e disponibilità contattare la sede.



J-365™

Design Jacuzzi®

new

231 x 214 x 97 H cm

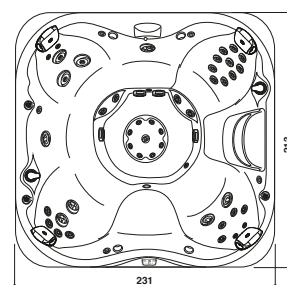

FEATURES · DOTAZIONI



FREESTANDING

	Seats (total) Sedute (totali)		6-7
	PowerPro® Jets Bocchette PowerPro®		46
	Waterfall with lights Cascata con luci		✓
	HydroSoothe™ cushion Cuscino HydroSoothe™		1
	Soft headrest Poggiatesta morbido		3
	Light System Multicolor Luci Multicolour		1
	LED control panel Pannello comandi LED		✓
	External corner lighting Illuminazione esterna angolare		✓
	(1) Remote control Telecomando		✓
	CLEARRAY® PRO ₃ TTECT™ UV-C + Low output ozone generator UV-C + Ozonizzatore a bassa emissione		✓
	SmartTub™	919405110 € 650	Optional

COLOURS · COLORI

31 32 38 49 65 70 84 85 98 99

SKIRTING · PANNELLI

		ProFinish™	BRUSHED GRAY	MODERN HARDWOOD	SMOKED EBONY
	(2) Insulating cover Copertura termica	ProLast™	GREY		
	Bluewave™ Stereo System		9445609*	9445608*	9445610*
			€ 20.842		
	Without Stereo System Senza Stereo System		9445606*	9445605*	9445607*
			€ 18.838		

ACCESSORIES · ACCESSORI

		ProFinish™	BRUSHED GRAY	MODERN HARDWOOD	SMOKED EBONY
	J-300™ Step Gradino		890011190	890011170	890011180
			€ 605		
	J-300™ Covermate by hand Sollevatore manuale per copertura termica		890010780		
			€ 506		
	J-300™ Covermate with pistons Sollevatore con pistoni per copertura termica		890011260		
			€ 699		

(1) The remote control is only available for versions provided with a stereo system

(1) Il telecomando è disponibile solo per le versioni con stereo.

(2) **COVER OPTIONS ProLast™: Black, Sienna - ProLast Extreme™: Black, Sienna, Grey - Vinyl: Silverwood, Bordeaux.** For orders and availability please contact our Customer Care.

(2) **OPZIONI COPERTURA ProLast™: Black, Sienna - ProLast Extreme™: Black, Sienna, Grey - Vinyl: Silverwood, Bordeaux.** Per ordini e disponibilità contattare la sede.



J-355™

Design Jacuzzi®

new

231 x 214 x 97 H cm

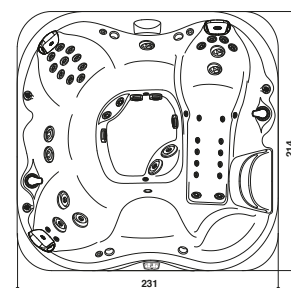

FEATURES · DOTAZIONI



FREESTANDING

	Seats (total) Sedute (totali)		5-6
	Lounge		1
	PowerPro® Jets Bocchette PowerPro®		44
	Waterfall with lights Cascata con luci		✓
	HydroSoothe™ cushion Cuscino HydroSoothe™		1
	Soft headrest Poggiatesta morbido		3
	Light System Multicolor Luci Multicolour		✓
	LED control panel Pannello comandi LED		✓
	External corner lighting Illuminazione esterna angolare		✓
	Remote control Telecomando		✓
	CLEARRAY® PRO ₃ TECT™ UV-C + Low output ozone generator UV-C + Ozonizzatore a bassa emissione		✓
	SmartTub™	919405110 € 650	Optional

COLOURS · COLORI

31 32 38 49 65 70 84 85 98 99

SKIRTING · PANNELLI

ProFinish™

BRUSHED GRAY **MODERN HARDWOOD** **SMOKED EBONY**

	Insulating cover Copertura termica	ProLast™			
	Bluewave™ Stereo System		9445621*	9445620*	9445622*
				€ 21.265	
	Without Stereo System Senza Stereo System		9445618*	9445617*	9445619*
				€ 19.223	

ACCESSORIES · ACCESSORI

		ProFinish™	BRUSHED GRAY	MODERN HARDWOOD	SMOKED EBONY
	J-300™ Step Gradino		890011190	890011170	890011180
				€ 605	
	J-300™ Covermate by hand Sollevatore manuale per copertura termica			890010780	
				€ 506	
	J-300™ Covermate with pistons Sollevatore con pistoni per copertura termica			890011260	
				€ 699	

(1) The remote control is only available for versions provided with a stereo system

(1) Il telecomando è disponibile solo per le versioni con stereo.

(2) **COVER OPTIONS ProLast™: Black, Sienna - ProLast Extreme™: Black, Sienna, Grey - Vinyl: Silverwood, Bordeaux.** For orders and availability please contact our Customer Care.

(2) **OPZIONI COPERTURA ProLast™: Black, Sienna - ProLast Extreme™: Black, Sienna, Grey - Vinyl: Silverwood, Bordeaux.** Per ordini e disponibilità contattare la sede.



J-345™

Design Jacuzzi®

new

214 x 214 x 92 H cm

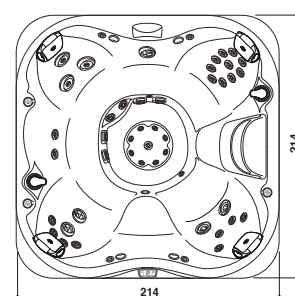

FEATURES · DOTAZIONI



FREESTANDING

	Seats (total) Sedute (totali)		6-7
	PowerPro® Jets Bocchette PowerPro®		41
	Waterfall with lights Cascata con luci		1
	HydroSoothe™ cushion Cuscino HydroSoothe™		1
	Soft headrest Poggiatesta morbido		3
	Light System Multicolor Luci Multicolour		1
	LED control panel Pannello comandi LED		✓
	External corner lighting Illuminazione esterna angolare		✓
	(1) Remote control Telecomando		✓
	CLEARRAY® PRO ₃ TECT™ UV-C + Low output ozone generator UV-C + Ozonizzatore a bassa emissione		✓
	SmartTub™	919405110 € 650	Optional

COLOURS · COLORI

31 32 38 49 65 70 84 85 98 99

SKIRTING · PANNELLI

	ProFinish™	BRUSHED GRAY	MODERN HARDWOOD	SMOKED EBONY
(2) Insulating cover Copertura termica	ProLast™		GREY	
Bluewave™ Stereo System		9445633*	9445632* € 19.641	9445634*
Without Stereo System Senza Stereo System		9445630*	9445629* € 17.704	9445631*

ACCESSORIES · ACCESSORI

	ProFinish™	BRUSHED GRAY	MODERN HARDWOOD	SMOKED EBONY
J-300™ Step Gradino		890011190	890011170	890011180
			€ 605	
J-300™ Covermate by hand Sollevatore manuale per copertura termica			890010780	
			€ 506	
J-300™ Covermate with pistons Sollevatore con pistoni per copertura termica			890011260	
			€ 699	

(1) The remote control is only available for versions provided with a stereo system

(1) Il telecomando è disponibile solo per le versioni con stereo.

(2) **COVER OPTIONS ProLast™: Black, Sienna - ProLast Extreme™: Black, Sienna, Grey - Vinyl: Silverwood, Bordeaux.** For orders and availability please contact our Customer Care.

(2) **OPZIONI COPERTURA ProLast™: Black, Sienna - ProLast Extreme™: Black, Sienna, Grey - Vinile: Silverwood, Bordeaux.** Per ordini e disponibilità contattare la sede.



J-335™

Design Jacuzzi®

new

214 x 214 x 92 H cm

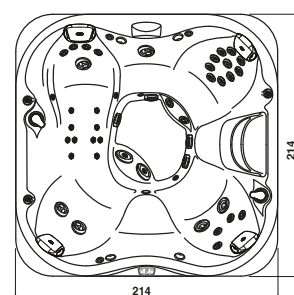

FEATURES · DOTAZIONI



FREESTANDING

	Seats (total) Sedute (totali)		5-6
	Lounge		1
	PowerPro® Jets Bocchette PowerPro®		42
	Waterfall with lights Cascata con luci		1
	HydroSoothe™ cushion Cuscino HydroSoothe™		1
	Soft headrest Poggiatesta morbido		3
	Light System Multicolor Luci Multicolour		✓
	LED control panel Pannello comandi LED		✓
	External corner lighting Illuminazione esterna angolare		✓
	(1) Remote control Telecomando		✓
	CLEARRAY® PRO ₃ TECT™ UV-C + Low output ozone generator UV-C + Ozonizzatore a bassa emissione		✓
	SmartTub™	919405110 € 650	Optional

COLOURS · COLORI

31 32 38 49 65 70 84 85 98 99

SKIRTING · PANNELLI

		ProFinish™	BRUSHED GRAY	MODERN HARDWOOD	SMOKED EBONY
	(2) Insulating cover Copertura termica	ProLast™	GREY		
	Bluewave™ Stereo System		9445645*	9445644*	9445646*
			€ 20.043		
	Without Stereo System Senza Stereo System		9445642*	9445641*	9445643*
			€ 18.066		

ACCESSORIES · ACCESSORI

		ProFinish™	BRUSHED GRAY	MODERN HARDWOOD	SMOKED EBONY
	J-300™ Step Gradino		890011190	890011170	890011180
			€ 605		
	J-300™ Covermate by hand Sollevatore manuale per copertura termica		890010780		
			€ 506		
	J-300™ Covermate with pistons Sollevatore con pistoni per copertura termica		890011260		
			€ 699		

(1) The remote control is only available for versions provided with a stereo system

(1) Il telecomando è disponibile solo per le versioni con stereo.

(2) **COVER OPTIONS ProLast™: Black, Sienna - ProLast Extreme™: Black, Sienna, Grey - Vinyl: Silverwood, Bordeaux.** For orders and availability please contact our Customer Care.

(2) **OPZIONI COPERTURA ProLast™: Black, Sienna - ProLast Extreme™: Black, Sienna, Grey - Vinyl: Silverwood, Bordeaux.** Per ordini e disponibilità contattare la sede.



J-325™

Design Jacuzzi®

new

193 x 213 x 87 H cm

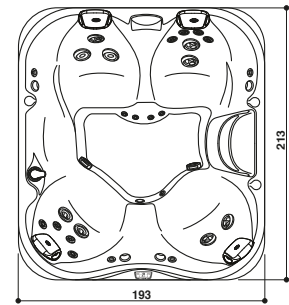

FREESTANDING

FEATURES · DOTAZIONI

	Seats (total) Sedute (totali)		4-5
	PowerPro® Jets Bocchette PowerPro®		23
	Waterfall with lights Cascata con luci		✓
	HydroSoothe™ cushion Cuscino HydroSoothe™		1
	Soft headrest Poggiatesta morbido		3
	Light System Multicolor Luci Multicolour		✓
	LED control panel Pannello comandi LED		✓
	External corner lighting Illuminazione esterna angolare		✓
	(1) Remote control Telecomando		✓
	CLEARRAY® PRO ₃ TECT™ UV-C + Low output ozone generator UV-C + Ozonizzatore a bassa emissione		✓
	SmartTub™	919405110 € 650	Optional

COLOURS · COLORI

31 32 38 49 65 70 84 85 98 99

SKIRTING · PANNELLI

	ProFinish™	BRUSHED GRAY	MODERN HARDWOOD	SMOKED EBONY
	(2) Insulating cover Copertura termica		GREY	
	Bluewave™ Stereo System	9445657*	9445656*	9445658*
			€ 18.463	
	Without Stereo System Senza Stereo System	9445654*	9445653*	9445655*
			€ 16.641	

ACCESSORIES · ACCESSORI

	ProFinish™	BRUSHED GRAY	MODERN HARDWOOD	SMOKED EBONY
	J-300™ Step Gradino	890011190	890011170	890011180
			€ 605	
	J-300™ Covermate by hand Sollevatore manuale per copertura termica		890010780	
			€ 506	
	J-300™ Covermate with pistons Sollevatore con pistoni per copertura termica		890011260	
			€ 699	

(1) The remote control is only available for versions provided with a stereo system

(1) Il telecomando è disponibile solo per le versioni con stereo.

(2) **COVER OPTIONS ProLast™: Black, Sienna - ProLast Extreme™: Black, Sienna, Grey - Vinyl: Silverwood, Bordeaux.** For orders and availability please contact our Customer Care.

(2) **OPZIONI COPERTURA ProLast™: Black, Sienna - ProLast Extreme™: Black, Sienna, Grey - Vinile: Silverwood, Bordeaux.** Per ordini e disponibilità contattare la sede.



J-315™

Design Jacuzzi®

193 x 168 x 81 H cm

new

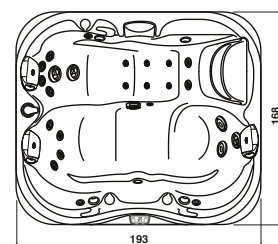

FEATURES · DOTAZIONI



FREESTANDING

	Seats (total) Sedute (totali)		2-3
	Lounge		1
	PowerPro® Jets Bocchette PowerPro®		23
	Waterfall with lights Cascata con luci		✓
	HydroSoothe™ cushion Cuscino HydroSoothe™		1
	Soft headrest Poggiatesta morbido		2
	Light System Multicolor Luci Multicolour		✓
	LED control panel Pannello comandi LED		✓
	External corner lighting Illuminazione esterna angolare		✓
	(1) Remote control Telecomando		✓
	CLEARRAY® PRO ₃ TECT™ UV-C + Low output ozone generator UV-C + Ozonizzatore a bassa emissione		✓
	SmartTub™	919405110 € 650	Optional

COLOURS · COLORI

31 32 38 49 65 70 84 85 98 99

SKIRTING · PANNELLI

		ProFinish™	BRUSHED GRAY	MODERN HARDWOOD	SMOKED EBONY
	(2) Insulating cover Copertura termica	ProLast™	GREY		
	SMART SEAL Bluewave™ Stereo System		9445669*	9445668*	9445670*
			€ 16.195		
	SMART SEAL Without Stereo System Senza Stereo System		9445666*	9445665*	9445667*
			€ 14.236		

ACCESSORIES · ACCESSORI

		ProFinish™	BRUSHED GRAY	MODERN HARDWOOD	SMOKED EBONY
	J-300™ Step Gradino		890011190	890011170	890011180
			€ 605		
	J-300™ Covermate by hand Sollevatore manuale per copertura termica		890010780		
			€ 506		
	J-300™ Covermate with pistons Sollevatore con pistoni per copertura termica		890011260		
			€ 699		

(1) The remote control is only available for versions provided with a stereo system

(1) Il telecomando è disponibile solo per le versioni con stereo.

(2) **COVER OPTIONS ProLast™: Black, Sienna - ProLast Extreme™: Black, Sienna, Grey - Vinyl: Silverwood, Bordeaux.** For orders and availability please contact our Customer Care.

(2) **OPZIONI COPERTURA ProLast™: Black, Sienna - ProLast Extreme™: Black, Sienna, Grey - Vinyl: Silverwood, Bordeaux.** Per ordini e disponibilità contattare la sede.



THE J-LX[®] EFFICIENT COLLECTION









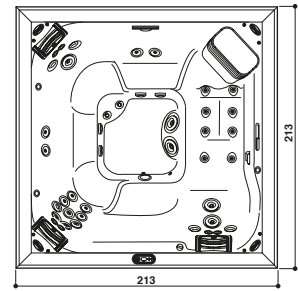









J-LXL®
Design Jacuzzi®

213 x 213 x 91 H cm



CAN BE ORDERED UNTIL 31TH MARCH 2020
ORDINABILE FINO AL 31 MARZO 2020

FEATURES · DOTAZIONI		 FREESTANDING	
 Seats (total) Sedute (totali)		5-6	
 Lounge		1	
 PowerPro® Jets Bocchette PowerPro®		38	
 Waterfall with lights Cascata con luci		1	
 Light System - Multicolour		✓	
 Headrest Poggiatesta		3	
 (1) Remote control Telecomando		✓	
 CLEARRAY® PRO ₃ TECT™ UV-C + Low output ozone generator UV-C + Ozonizzatore a bassa emissione		✓	
COLOURS · COLORI		31 32 38 49 65 70 84 85 98 99	
SKIRTING · PANNELLI		BRAZILIAN TEAK	ROASTED CHESTNUT
 Insulating cover Copertura termica	Vinyl leatherette Vinilpelle	BORDEAUX	
  Bluewave™ Stereo System		9444940*	9444942*
		€ 20.962	
ACCESSORIES · ACCESSORI		BRAZILIAN TEAK	ROASTED CHESTNUT
 J-LX™ Prostep™ entry system Prostep™ scala		890010680	890010690
		€ 1.214	
 J-LX™ Covermate by hand Sollevatore manuale per copertura termica		890010780	
		€ 506	

(1) The remote control is only available for versions provided with a stereo system

(1) Il telecomando è disponibile solo per le versioni con stereo



THE DESIGN COLLECTION





INSTRUCTIONS FOR ORDERING

Dimensions and descriptions are indicated in the master brochure and in this price list.

Orders must include:

- a) name
- b) hot tub code
- c) colour code
(replace the asterisk with the reference number of the chosen colour)

I.e.

SPA: J-585™ SILVERWOOD
Colour: Desert Sand
Bluewave™ Stereo System (Wireless + AUX)

- J-585 944626770

COME ORDINARE

Per la descrizione e dimensioni, riferirsi al catalogo ed al prospetto del listino.

Gli ordini devono includere:

- a) nome
- b) codice spa
- c) codice colore
(al posto dell'asterisco mettere il riferimento numerico del colore prescelto)

Es.

SPA: J-585™ SILVERWOOD
Colore: Desert Sand
Bluewave™ Stereo System (Wireless + AUX)

- J-585 944626770



VIRTUS

Design Dodo Arslan e Jacuzzi® Design

250 x 215 x 93 H cm

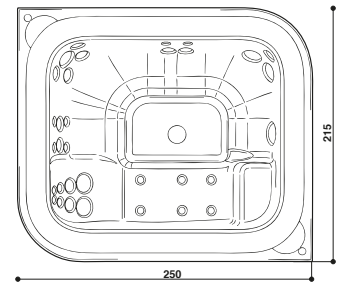

FEATURES · DOTAZIONI

	Seats (total) Sedute (totali)	6-7
	Lounge	1
	PowerPro® Jets Bocchette PowerPro®	50
	Light System - Multicolour	2
	LED control panel Pannello comandi LED	✓
	Back-lit touch controls Comandi Touch retroilluminati	2
	Smart Access Door Pannello "Smart Access"	✓
	Automatic water fill-up Rabocco acqua automatico	✓
	Quick drain Svuotamento rapido	✓
	Filter with 4-way valve, polymer fibers (included) Filtro con valvola 4 vie, fibre di polimeri (inclusi)	✓
	CLEARRAY® PRO ₃ TECT™ UV-C + Low output ozone generator UV-C + Ozonizzatore a bassa emissione	✓
	3kW electric heater Riscaldatore elettrico 3kW	○
	Heat Exchanger Scambiatore di calore	○
	Eco shield insulation Isolamento Eco Shield	○
	Thermal cover in two folding parts Copertura termica in due parti pieghevoli	Marine-grade fabric Tessuto nautico
		52 65

COLOURS · COLORI

INSULATION · ISOLAMENTO

3KW ELECTRIC HEATER · RISCALDATORE ELETTRICO 3KW

	Built-in	VIR10023050	VIR11023050			
		€ 20.385				
	Freestanding	TEAK	VIR10023053	VIR11023053	VIR10023353	VIR11023353
		GRAPHITE	VIR10023054	VIR1023054	VIR10023354	VIR11023354
		€ 23.285		€ 24.500		

HEAT EXCHANGER · SCAMBIATORE DI CALORE

	Built-in	VIR10021050	VIR11021050			
		€ 20.905				
	Freestanding	TEAK	VIR10021053	VIR11022053	VIR10021353	VIR11021353
		GRAPHITE	VIR10021054	VIR11022054	VIR10021354	VIR11021354
		€ 23.805		€ 25.020		

OPTIONAL

MARINE KIT

To use with seawater (titanium heater, AISI 316 L frame)
Per l'impiego con acqua di mare (riscaldatore in titanio, telaio in AISI 316 L)

on request · su richiesta

€ 1.350

✓ Standard · Standard ○ Depending on the version · A seconda della versione



PROFILE

Design Jacuzzi®

235 x 211 x 93 H cm Built-in / Freestanding Graphite
239 x 125 x 93 H cm Freestanding Teak

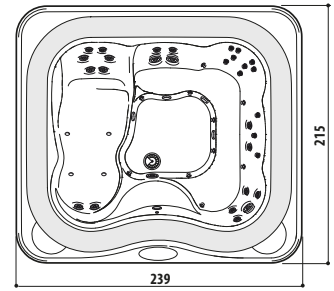

FEATURES · DOTAZIONI	BUILT-IN		FREESTANDING	
	BASE	TOP	BASE	TOP
Seats (total) Sedute (totali)			5-6	
Lounge			1	
PowerPro® Jets Bocchette PowerPro®			31	
Blowers			14	
Light System Multicolour			✓	
Automatic water fill-up Rabbocco acqua automatico			✓	
LCD control panel Pannello comandi LCD			✓	
Aromatherapy Aromaterapia			✓	
Insound System Wireless			TOP version only · Solo versione TOP	
CLEARRAY® UV-C system			✓	
Insulating cover Copertura termica		Marine-grade fabric Tessuto nautico	ICE	

COLOURS · COLORI

52 65 97

SKIRTING · PANNELLI	BUILT-IN		FREESTANDING			
			TEAK		GRAPHITE Synthetic wood Legno sintetico	
	BASE	TOP	BASE	TOP	BASE	TOP
	9444861*	9444862*	9444863*	9444864*	9444865*	9444866*
	€ 19.985	€ 22.911	€ 22.770	€ 25.696	€ 22.770	€ 25.696

OPTIONAL

Winter Pro Kit	943613030
	€ 887
Performance Kit · Sand not included La sabbia non è inclusa	94428200
	€ 1.458
1 x 25 kg bag of sand 1 Sacco sabbia kg 25	23320507
	€ 39



FLOW

Design Daniel Libeskind

200 x 200 x (Ø 224) 81 H cm

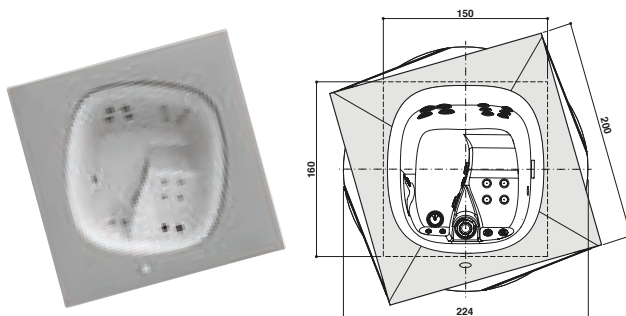

**PLEASE CONTACT OUR OFFICES FOR ORDERS AND AVAILABILITY.
PER ORDINI E DISPONIBILITÀ CONTATTARE LA SEDE.**



FEATURES · DOTAZIONI

		FREESTANDING
	Seats (total) Sedute (totali)	2
	Lounge	2
	PowerPro® Jets Bocchette PowerPro®	20
	Light System - Multicolor	✓
	LED control panel Pannello comandi LED	✓
	CLEARRAY® UV-C system	✓
	Audio System	✓
	Insulating cover Copertura termica	Vinyl leatherette Vinilpelle
		PLATIN

COLOURS · COLORI

		52		FREESTANDING				
	Standard packing Imballo standard	With heater Con riscaldatore	1,5 kW	+	Kit Flow (1)	9445019*	+	9440554A
			2 kW	+	Kit Flow (1)	€ 11.220	+	€ 6.948
	Packing for container Imballo per container	With heater Con riscaldatore	1,5 kW	+	Kit Flow (1)	9445020*	+	9440554A
			2 kW	+	Kit Flow (1)	€ 11.465	+	€ 6.948
	Packing for container Imballo per container	With heater Con riscaldatore	1,5 kW	+	Kit Flow (1)	9445069*	+	9440554A
			2 kW	+	Kit Flow (1)	€ 11.658	+	€ 6.948
						9445070*	+	9440554A
						€ 11.892	+	€ 6.948

OPTIONAL

	Winter Pro Kit	943613080
		€ 650

**THE TWO CODES MUST ALWAYS BE ORDERED TOGETHER.
JACUZZI® ADVISES AGAINST OUTDOOR INSTALLATION.**

**È SEMPRE NECESSARIO ORDINARE I DUE CODICI CONGIUNTAMENTE.
JACUZZI® SCONSIGLIA L'INSTALLAZIONE OUTDOOR (ESTERNA).**

(1) Kit Flow = fronts with frame, top, insulating cover and "cover cap."

(1) Kit Flow = frontali con telaio, top, copertura termica e "cuffia di protezione".



CITY™ SPA

Design Kaluderovic & Condini

160 x 150 x 75 H cm

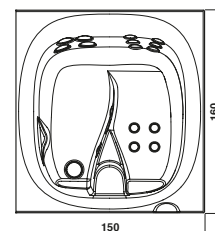

FEATURES · DOTAZIONI

		BUILT-IN	FREESTANDING
	Seats (total) Sedute (totali)		2
	Lounge		2
	PowerPro® Jets Bocchette PowerPro®		20
	Light System - Multicolor		✓
	LED control panel Pannello comandi LED		✓
	CLEARRAY® UV-C system		✓
	Insulating cover Copertura termica	Vinyl leatherette Vinilpelle	ICE

COLOURS · COLORI

52

SKIRTING · PANNELLI

		BUILT-IN	FREESTANDING				
			TEAK Wood · Legno	SAHARA Synthetic wood Legno sintetico	Sasha panels Pannelli Sasha	Customisable panels Pannelli personalizzabili	
	Audio System Wireless	With heater Con riscaldatore 1,5 kW	9444749*	9444757*	9444765*	9444773*	9444781*
	Without Audio System Senza Audio System		€ 11.918	€ 13.572	€ 14.046	€ 15.051	€ 13.062
	Without Audio System Senza Audio System	With heater Con riscaldatore 2 kW	9444751*	9444759*	9444767*	9444775*	9444783*
	Without Audio System Senza Audio System		€ 9.673	€ 11.327	€ 11.801	€ 12.805	€ 10.816
	Audio System Wireless	With heater Con riscaldatore 2 kW	9444753*	9444761*	9444769*	9444777*	9444785*
	Without Audio System Senza Audio System		€ 12.154	€ 13.810	€ 14.283	€ 15.288	€ 13.297
	Without Audio System Senza Audio System		9444755*	9444763*	9444771*	9444779*	9444787*
	Without Audio System Senza Audio System		€ 9.909	€ 11.564	€ 12.037	€ 13.041	€ 11.051

OPTIONAL

	Winter Pro Kit	943613080
		€ 650



DELFI

Design Kaluderovic & Condini

190 x 190 x 80 H cm

- (A) Cushion: optional
Cuscino: optional
- (B,C) Headrest: optional
Poggiatesta: optional

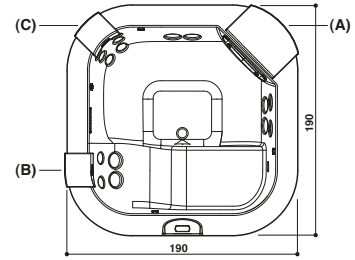
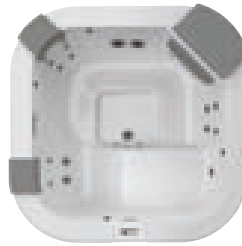

FEATURES · DOTAZIONI

		BUILT-IN	FREESTANDING	
	Seats (total) · Sedute (totali)		4	
	Lounge		1	
	PowerPro® Jets Bocchette PowerPro®		16	
	White spotlight Faro bianco		✓	
	LED control panel Pannello comandi LED		✓	
	CLEARRAY® UV-C system		Optional	
	Insulating cover Copertura termica	Vinyl leatherette Vinilpelle	ICE	

COLOURS · COLORI

52 **65** **97**

SKIRTING · PANNELLI

		BUILT-IN	FREESTANDING	
			TEAK	GRAPHITE Synthetic wood Legno sintetico
		9444789*	9444790*	9444791*
		€ 10.682	€ 13.152	€ 13.152

OPTIONAL

	CLEARRAY® UV-C system	94360100	€ 748
	(A) Cushion Cuscino	225016950	€ 207
	(B) Headrest Poggiatesta	225016910	€ 194
	(C) Headrest Poggiatesta	225016930	€ 194
	Winter Pro Kit	943613070	€ 887
	Performance Kit · Sand not included La sabbia non è inclusa	94428200	€ 1.458
	1 x 25 kg bag of sand 1 Sacco sabbia kg 25	23320507	€ 39



DELFI PRO

Design Kaluderovic & Condini

190 x 190 x 80 H cm

(A) Cushion: optional
Cuscino: optional

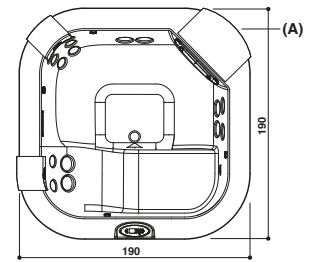
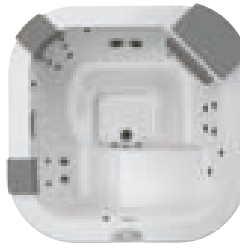

FEATURES · DOTAZIONI

		BUILT-IN	FREESTANDING	
	Seats (total) Sedute (totali)		4	
	Lounge		1	
	PowerPro® Jets Bocchette PowerPro®		16	
	White spotlight Faro bianco		✓	
	Cascade Cascata		✓	
	Headrest Poggiatesta		2	
	LCD control panel Pannello comandi LCD		✓	
	CLEARRAY® UV-C system		Optional	
	Insulating cover Copertura termica	Vinyl leatherette Vinilpelle	ICE	

COLOURS · COLORI

52 **65** **97**

		BUILT-IN	FREESTANDING		
			TEAK	GRAPHITE Synthetic wood Legno sintetico	VEINED OAK ROVERE RIGATO
	With heater Con riscaldatore	9444792* € 13.468	9444794* € 15.644	9444796* € 15.644	9444798* € 16.438
	With heat exchanger Con scambiatore di calore	9444793* € 14.007	9444795* € 16.180	9444797* € 16.180	9444799* € 16.975

OPTIONAL

	CLEARRAY® UV-C system	94360100 € 748
	(A) Cushion Cuscino	225016950 € 207
	Winter Pro Kit	943613070 € 887
	Performance Kit · Sand not included La sabbia non è inclusa	94428200 € 1.458
	1 x 25 kg bag of sand 1 Sacco sabbia kg 25	23320507 € 39



DELFI PRO SOUND

Design Kaluderovic & Conдини

190 x 190 x 80 H cm

(A) Cushion: optional
Cuscino: optional

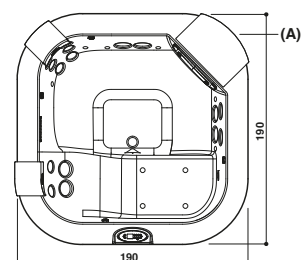

FEATURES · DOTAZIONI

		BUILT-IN	FREESTANDING	
	Seats (total) Sedute (totali)		4	
	Lounge		1	
	PowerPro® Jets Bocchette PowerPro®		16	
	Blowers		10	
	Light System - Multicolour		✓	
	Cascade Cascata		✓	
	Headrest Poggiatesta		2	
	LCD control panel Pannello comandi LCD		✓	
	Aromatherapy Aromaterapia		✓	
	CLEARRAY® UV-C system		✓	
	Audio System Wireless		✓	
	Insulating cover Copertura termica	Vinyl leatherette Vinilpelle	ICE	

COLOURS · COLORI

52 65 97

SKIRTING · PANNELLI

		BUILT-IN	FREESTANDING		
			TEAK	GRAPHITE Synthetic wood Legno sintetico	VEINED OAK ROVERE RIGATO
	With heater Con riscaldatore	9444800*	9444802*	9444804*	9444806*
		€ 16.142	€ 18.394	€ 18.394	€ 19.116
	With heat exchanger Con scambiatore di calore	9444801*	9444803*	9444805*	9444807*
		€ 16.680	€ 18.929	€ 18.929	€ 19.653

OPTIONAL

	(A) Cushion Cuscino	225016950	€ 207
	Winter Pro Kit	943613070	€ 887
	Performance Kit · Sand not included La sabbia non è inclusa	94428200	€ 1.458
	1 x 25 kg bag of sand 1 Sacco sabbia kg 25	23320507	€ 39

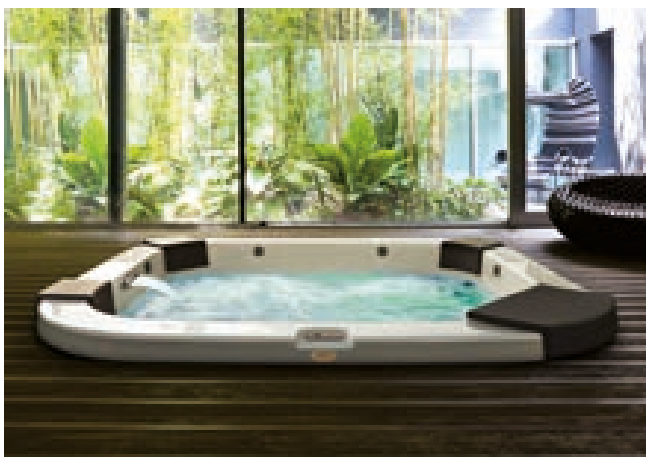

DELOS

Design Kaluderovic & Condini

215 x 190 x 80 H cm

- (A) Cushion: optional
Cuscino: optional
- (B,C) Headrest: optional
Poggiatesta: optional

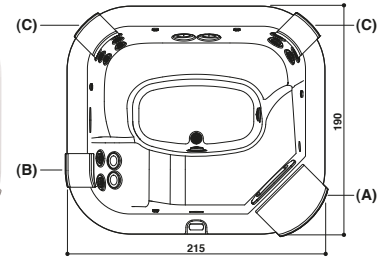

FEATURES · DOTAZIONI

		BUILT-IN	FREESTANDING
	Seats (total) Sedute (totali)		4
	Lounge		1
	PowerPro® Jets Bocchette PowerPro®		16
	White spotlight Faro bianco		✓
	LED control panel Pannello comandi LED		✓
	CLEARRAY® UV-C system		Optional
	Insulating cover Copertura termica	Vinyl leatherette Vinilpelle	ICE

COLOURS · COLORI

52 65 97

SKIRTING · PANNELLI

	BUILT-IN	FREESTANDING	
		TEAK	GRAPHITE Synthetic wood Legno sintetico
	9444808*	9444809*	9444810*
	€ 11.384	€ 13.916	€ 13.916

OPTIONAL

	CLEARRAY® UV-C system	94360100	€ 748
	(A) Cushion Cuscino	225016950	€ 207
	(B) Headrest Poggiatesta	225016910	€ 194
	(C) Headrest Poggiatesta	225016930	€ 194
	Winter Pro Kit	943613060	€ 887
	Performance Kit · Sand not included La sabbia non è inclusa	94428200	€ 1.458
	1 x 25 kg bag of sand 1 Sacco sabbia kg 25	23320507	€ 39

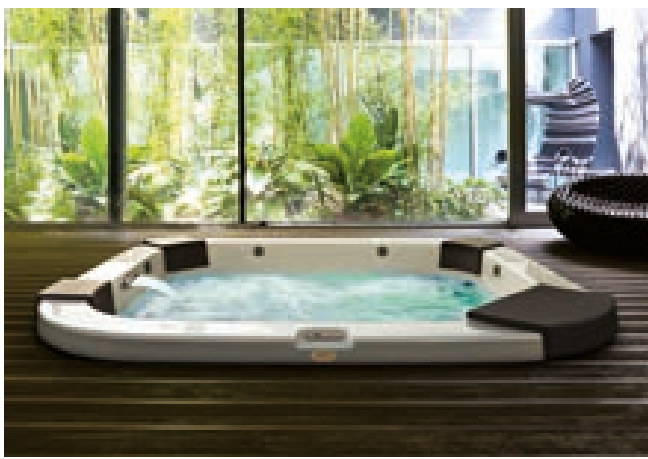

DELOS PRO

Design Kaluderovic & Conдини

215 x 190 x 80 H cm

(A) Cushion: optional
Cuscino: optional

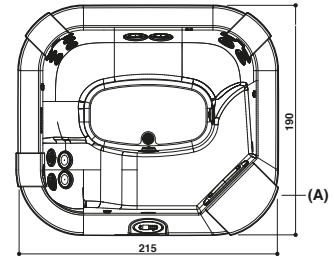

FEATURES · DOTAZIONI

		BUILT-IN	FREESTANDING	
	Seats (total) Sedute (totali)		4	
	Lounge		1	
	PowerPro® Jets Bocchette PowerPro®		16	
	White spotlight Faro bianco		✓	
	Cascade Cascata		✓	
	Headrest Poggiatesta		3	
	LCD control panel Pannello comandi LCD		✓	
	CLEARRAY® UV-C system		Optional	
	Insulating cover Copertura termica	Vinyl leatherette Vinilpelle	ICE	

COLOURS · COLORI

52 65 97

		BUILT-IN	FREESTANDING		
			TEAK	GRAPHITE Synthetic wood Legno sintetico	VEINED OAK ROVERE RIGATO
	With heater Con riscaldatore	9444811* € 14.193	9444813* € 16.563	9444815* € 16.563	9444817* € 17.315
	With heat exchanger Con scambiatore di calore	9444812* € 14.731	9444814* € 17.101	9444816* € 17.101	9444818* € 17.853

OPTIONAL

	CLEARRAY® UV-C system	94360100 € 748
	(A) Cushion Cuscino	225016950 € 207
	Winter Pro Kit	943613060 € 887
	Performance Kit · Sand not included La sabbia non è inclusa	94428200 € 1.458
	1 x 25 kg bag of sand 1 Sacco sabbia kg 25	23320507 € 39



DELOS PRO SOUND

Design Kaluderovic & Condini

215 x 190 x 80 H cm

(A) Cushion: optional
Cuscino: optional

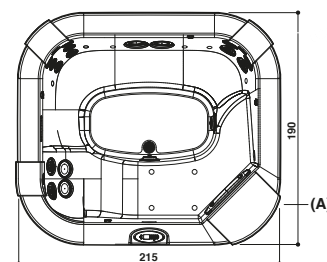

FEATURES · DOTAZIONI

		BUILT-IN	FREESTANDING	
	Seats (total) Sedute (totali)		4	
	Lounge		1	
	PowerPro® Jets Bocchette PowerPro®		16	
	Blowers		10	
	Light System - Multicolour		✓	
	Cascade Cascata		✓	
	Headrest Poggiatesta		3	
	LCD control panel Pannello comandi LCD		✓	
	Aromatherapy Aromaterapia		✓	
	CLEARRAY® UV-C system		✓	
	Audio System Wireless		✓	
	Insulating cover Copertura termica	Vinyl leatherette Vinilpelle	ICE	

COLOURS · COLORI

52 65 97

SKIRTING · PANNELLI

		BUILT-IN	FREESTANDING		
			TEAK	GRAPHITE Synthetic wood Legno sintetico	VEINED OAK ROVERE RIGATO
	With heater Con riscaldatore	9444819* € 17.004	9444821* € 19.375	9444823* € 19.375	9444825* € 20.133
	With heat exchanger Con scambiatore di calore	9444820* € 17.542	9444822* € 19.911	9444824* € 19.911	9444826* € 20.672

OPTIONAL

	(A) Cushion Cuscino	225016950 € 207
	Winter Pro Kit	943613060 € 887
	Performance Kit · Sand not included La sabbia non è inclusa	94428200 € 1.458
	1 x 25 kg bag of sand 1 Sacco sabbia kg 25	23320507 € 39



SANTORINI PRO

Design Kaluderovic & Condini

230 x 215 x 90 H cm

(A) Cushion: optional
Cuscino: optional

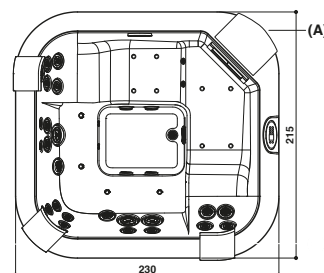

FEATURES · DOTAZIONI

		BUILT-IN	FREESTANDING	
	Seats (total) Sedute (totali)		5	
	Lounge		2	
	PowerPro® Jets Bocchette PowerPro®		29	
	Blowers		14	
	Light System - Multicolour		✓	
	Cascade Cascata		✓	
	Headrest Poggiatesta		3	
	LCD control panel Pannello comandi LCD		✓	
	Aromatherapy Aromaterapia		✓	
	CLEARRAY® UV-C system		✓	
	Insulating cover Copertura termica	Vinyl leatherette Vinilpelle	ICE	

COLOURS · COLORI

52 **65** **97**

		BUILT-IN	FREESTANDING		
			TEAK	GRAPHITE Synthetic wood Legno sintetico	VEINED OAK ROVERE RIGATO
	With heater Con riscaldatore	9444827* € 17.875	9444829* € 20.661	9444831* € 20.661	9444833* € 21.555
	With heat exchanger Con scambiatore di calore	9444828* € 18.412	9444830* € 21.199	9444832* € 21.199	9444834* € 22.094

OPTIONAL

	(A) Cushion Cuscino	225016950 € 207
	Winter Pro Kit	943613050 € 887
	Performance Kit · Sand not included La sabbia non è inclusa	94428200 € 1.458
	1 x 25 kg bag of sand 1 Sacco sabbia kg 25	23320507 € 39



SANTORINI PRO SOUND

Design Kaluderovic & Condini

230 x 215 x 90 H cm

(A) Cushion: optional
Cuscino: optional

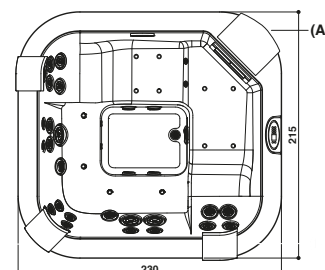

FEATURES · DOTAZIONI

		BUILT-IN	FREESTANDING	
	Seats (total) Sedute (totali)		5	
	Lounge		2	
	PowerPro® Jets Bocchette PowerPro®		29	
	Blowers		14	
	Light System - Multicolour		✓	
	Cascade Cascata		✓	
	Headrest Poggiatesta		3	
	LCD control panel Pannello comandi LCD		✓	
	Aromatherapy Aromaterapia		✓	
	CLEARRAY® UV-C system		✓	
	Audio System Wireless		✓	
	Insulating cover Copertura termica	Vinyl leatherette Vinilpelle	ICE	

COLOURS · COLORI

52 65 97

SKIRTING · PANNELLI

		BUILT-IN	FREESTANDING		
			TEAK	GRAPHITE Synthetic wood Legno sintetico	VEINED OAK ROVERE RIGATO
	With heater Con riscaldatore	9444835* € 20.176	9444837* € 22.963	9444839* € 22.963	9444841* € 23.858
	With heat exchanger Con scambiatore di calore	9444836* € 20.713	9444838* € 23.499	9444840* € 23.499	9444842* € 24.393

OPTIONAL

	(A) Cushion Cuscino	225016950 € 207
	Winter Pro Kit	943613050 € 887
	Performance Kit · Sand not included La sabbia non è inclusa	94428200 € 1.458
	1 x 25 kg bag of sand 1 Sacco sabbia kg 25	23320507 € 39



UNIQUE

Design Carlo Urbinati

190 x 150 x 80 H cm

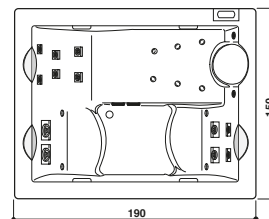

FEATURES · DOTAZIONI

	BASE	TOP
Seats (total) Sedute (totali)		3
Lounge		1
PowerPro® Jets Bocchette PowerPro®		14
Blowers		10
Light System - Multicolour		✓
Headrest Poggiatesta		3
LED control panel Pannello comandi LED		✓
CLEARRAY® UV-C system	Optional	✓
Audio System Wireless		✓
Insulating cover Copertura termica	ICE	

COLOURS · COLORI

52 65

SKIRTING · PANNELLI

		BUILT-IN	FREESTANDING				
			(A) WENGÉ Wood · Legno	TEAK Wood · Legno	SAHARA Synthetic wood Legno sintetico	Customisable panels · Pannelli personalizzabili	
BASE		Vinyl leatherette Vinilpelle	9445073*	9445074*	9445075*	9445076*	9445077*
			€ 12.013	€ 14.558	€ 13.650	€ 13.107	€ 12.998
TOP	Insulating cover	Fabric, can be used as a sunbed In tessuto, prendisole	9445078*	9445079*	9445080*	9445081*	9445082*
			€ 12.894	€ 15.440	€ 14.530	€ 13.986	€ 13.878
		Vinyl leatherette Vinilpelle	9445083*	9445084*	9445085*	9445086*	9445087*
			€ 15.291	€ 17.838	€ 16.928	€ 16.385	€ 16.277
		9445088*	9445089*	9445090*	9445091*	9445092*	
		€ 16.173	€ 18.718	€ 17.809	€ 17.266	€ 17.158	

OPTIONAL

	CLEARRAY® UV-C system BASE version only · Solo versione BASE	94360100 € 748
	Winter Pro Kit	943613040 € 887
	Performance Kit · Sand not included La sabbia non è inclusa	94428200 € 1.458
	1 x 25 kg bag of sand 1 Sacco sabbia kg 25	23320507 € 39

(A) For indoor installation only.

(A) Solo per installazione interno.



ALIMIA

Design Jacuzzi®

Ø 212 x 90 H cm

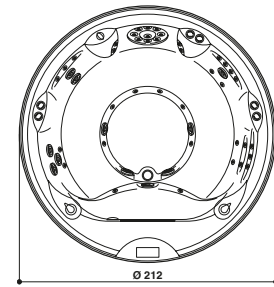

FEATURES · DOTAZIONI

		BUILT-IN	FREESTANDING
	Seats (total) Sedute (totali)		5-6
	Jets Bocchette		34
	Blowers		12
	Light System - Multicolour		✓
	LCD control panel Pannello comandi LCD		✓
	Aromatherapy Aromaterapia		✓
	CLEARRAY® UV-C system		✓
	Insulating cover Copertura termica	Vinyl leatherette Vinilpelle	ICE

COLOURS · COLORI

52 **65** **97**

		BUILT-IN	FREESTANDING
SKIRTING · PANNELLI			GRAPHITE SYNTHETIC WOOD LEGNO SINTETICO
		9444867*	9445133*
		€ 18.178	€ 21.163



OXIA

Design Jacuzzi®

200 x 185 x 90 H cm

204 x 189 x 90 H cm (Wood)

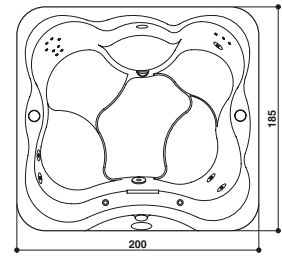

FEATURES · DOTAZIONI

		BUILT-IN	FREESTANDING
	Seats (total) Sedute (totali)		3-4
	Jets Bocchette		17
	White spotlight Faro bianco		✓
	LCD control panel Pannello comandi LCD		✓
	Insulating cover Copertura termica	Vinyl leatherette Vinilpelle	ICE

COLOURS · COLORI

52 65 97

	BUILT-IN	FREESTANDING	
		WHITE ACRYLIC PANELS PANNELLI ACRILICO BIANCO	TEAK
	9444868*	9444869*	9444870*
	€ 10.822	€ 11.463	€ 12.018

SKIRTING · PANNELLI

OPTIONAL

	CLEARRAY® UV-C system	94360100	€ 748
	Performance Kit · Sand not included La sabbia non è inclusa	94428200	€ 1.458
	1 x 25 kg bag of sand 1 Sacco sabbia kg 25	23320507	€ 39



THE LODGE COLLECTION





FEATURES · DOTAZIONI		LODGE S	LODGE M	LODGE L
Dimensions Dimensioni		185 x 165 x 90H cm	200 x 185 x 90H cm	223 x 211 x 90H cm
	Seats (total) Sedute (totali)	2-3	4-5	5-6
	Lounge	1		1
	Jets Bocchette	HYDRO	20	24
		HYDRO+BLOWER		
	Blowers	BLOWER	12	14
		BLOWER+HYDRO		
	Light System LED Multicolour	✓		
	LED control panel Pannello comandi LED	✓		
	Insulating cover Copertura termica	Vinyl leatherette Vinilpelle		
	Insulation full foam Isolamento schiuma poliuretanic	NORDIC		
	Skirting Pannelli	SILVERWOOD · ROASTED CHESTNUT		
	Heat exchanger Scambiatore di calore	○		
	Electric heater (2 kW) and circulation pump Riscaldatore elettrico (2 kW) e pompa di ricircolo	○		
	Electric heater (3 kW) and circulation pump Riscaldatore elettrico (3 kW) e pompa di ricircolo		○	○
	CLEARRAY® UV	✓		
OPTIONAL		LODGE S	LODGE M	LODGE L
	Additional electric heater (3+3 kW) Riscaldatore elettrico aggiuntivo (3+3 kW)		943613090	
			€ 557	
	Performance Kit · Sand not included La sabbia non è inclusa		94428200	
			€ 1.458	
	1 x 25 kg bag of sand 1 Sacco sabbia kg 25		23320507	
			€ 39	
	Cover lifter Sollevatore per copertura termica		890010780	
			€ 506	



LODGE S

Design Jacuzzi®

185 x 165 x 90 H cm

Drawing shows the HYDRO version
Disegno raffigurante la versione HYDRO

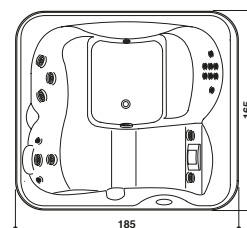

HYDRO

		BUILT-IN		FREESTANDING			
SKIRTING · PANNELLI				SILVERWOOD		ROASTED CHESTNUT	
INSULATION · ISOLAMENTO		Standard	Nordic	Standard	Nordic	Standard	Nordic
Electric heater Riscaldatore elettrico 3 kW	Bianco	LOD10025010	LOD10025110	LOD10025011	LOD10025111	LOD10025012	LOD10025112
	Platinum	LOD11025010	LOD11025110	LOD11025011	LOD11025111	LOD11025012	LOD11025112
	White Pearlescent	LOD10225010	LOD10225110	LOD10225011	LOD10225111	LOD10225012	LOD10225112
		€ 7.259	€ 8.153	€ 9.152	€ 10.046	€ 9.152	€ 10.046
Heat exchanger Scambiatore di calore	Bianco	LOD10021010	LOD10021110	LOD10021011	LOD10021111	LOD10021012	LOD10021112
	Platinum	LOD11021010	LOD11021110	LOD11021011	LOD11021111	LOD11021012	LOD11021112
	White Pearlescent	LOD10221010	LOD10221110	LOD10221011	LOD10221111	LOD10221012	LOD10221112
		€ 7.424	€ 8.318	€ 9.317	€ 10.211	€ 9.317	€ 10.211

HYDRO-BLOWER

		BUILT-IN		FREESTANDING			
SKIRTING · PANNELLI				SILVERWOOD		ROASTED CHESTNUT	
INSULATION · ISOLAMENTO		Standard	Nordic	Standard	Nordic	Standard	Nordic
Electric heater Riscaldatore elettrico 3 kW	Bianco	LOD10035010	LOD10035110	LOD10035011	LOD10035111	LOD10035012	LOD10035112
	Platinum	LOD11035010	LOD11035110	LOD11035011	LOD11035111	LOD11035012	LOD11035112
	White Pearlescent	LOD10235010	LOD10235110	LOD10235011	LOD10235111	LOD10235012	LOD10235112
		€ 7.746	€ 8.640	€ 9.639	€ 10.533	€ 9.639	€ 10.533
Heat exchanger Scambiatore di calore	Bianco	LOD10031010	LOD10031110	LOD10031011	LOD10031111	LOD10031012	LOD10031112
	Platinum	LOD11031010	LOD11031110	LOD11031011	LOD11031111	LOD11031012	LOD11031112
	White Pearlescent	LOD10231010	LOD10231110	LOD10231011	LOD10231111	LOD10231012	LOD10231112
		€ 7.911	€ 8.805	€ 9.804	€ 10.698	€ 9.804	€ 10.698

BLOWER

		BUILT-IN		FREESTANDING			
SKIRTING · PANNELLI				SILVERWOOD		ROASTED CHESTNUT	
INSULATION · ISOLAMENTO		Standard	Nordic	Standard	Nordic	Standard	Nordic
Electric heater Riscaldatore elettrico 3 kW	Bianco	LOD10015010	LOD10015110	LOD10015011	LOD10015111	LOD10015012	LOD10015112
	Platinum	LOD11015010	LOD11015110	LOD11015011	LOD11015111	LOD11015012	LOD11015112
	White Pearlescent	LOD10215010	LOD10215110	LOD10215011	LOD10215111	LOD10215012	LOD10215112
		€ 7.318	€ 8.212	€ 9.211	€ 10.105	€ 9.211	€ 10.105
Heat exchanger Scambiatore di calore	Bianco	LOD10011010	LOD10011110	LOD10011011	LOD10011111	LOD10011012	LOD10011112
	Platinum	LOD11011010	LOD11011110	LOD11011011	LOD11011111	LOD11011012	LOD11011112
	White Pearlescent	LOD10211010	LOD10211110	LOD10211011	LOD10211111	LOD10211012	LOD10211112
		€ 6.743	€ 7.637	€ 8.636	€ 9.530	€ 8.636	€ 9.530



LODGE M

Design Jacuzzi®

200 x 185 x 90 H cm

Drawing shows the HYDRO version
Disegno raffigurante la versione HYDRO

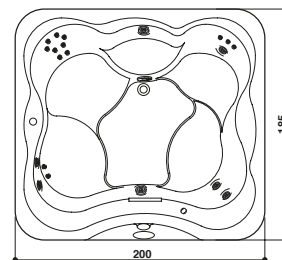

HYDRO

		BUILT-IN		FREESTANDING			
SKIRTING · PANNELLI				SILVERWOOD		ROASTED CHESTNUT	
INSULATION · ISOLAMENTO		Standard	Nordic	Standard	Nordic	Standard	Nordic
Electric heater Riscaldatore elettrico 3 kW	Bianco	LOD20025010	LOD20025110	LOD20025011	LOD20025111	LOD20025012	LOD20025112
	Platinum	LOD21025010	LOD21025110	LOD21025011	LOD21025111	LOD21025012	LOD21025112
	White Pearlescent	LOD20225010	LOD20225110	LOD20225011	LOD20225111	LOD20225012	LOD20225112
		€ 8.001	€ 8.895	€ 9.894	€ 10.788	€ 9.894	€ 10.788
Heat exchanger Scambiatore di calore	Bianco	LOD20021010	LOD20021110	LOD20021011	LOD20021111	LOD20021012	LOD20021112
	Platinum	LOD21021010	LOD21021110	LOD21021011	LOD21021111	LOD21021012	LOD21021112
	White Pearlescent	LOD20221010	LOD20221110	LOD20221011	LOD20221111	LOD20221012	LOD20221112
		€ 8.166	€ 9.060	€ 10.059	€ 10.953	€ 10.059	€ 10.953

HYDRO-BLOWER

		BUILT-IN		FREESTANDING			
SKIRTING · PANNELLI				SILVERWOOD		ROASTED CHESTNUT	
INSULATION · ISOLAMENTO		Standard	Nordic	Standard	Nordic	Standard	Nordic
Electric heater Riscaldatore elettrico 3 kW	Bianco	LOD20035010	LOD20035110	LOD20035011	LOD20035111	LOD20035012	LOD20035112
	Platinum	LOD21035010	LOD21035110	LOD21035011	LOD21035111	LOD21035012	LOD21035112
	White Pearlescent	LOD20235010	LOD20235110	LOD20235011	LOD20235111	LOD20235012	LOD20235112
		€ 8.542	€ 9.436	€ 10.435	€ 11.329	€ 10.435	€ 11.329
Heat exchanger Scambiatore di calore	Bianco	LOD20031010	LOD20031110	LOD20031011	LOD20031111	LOD20031012	LOD20031112
	Platinum	LOD21031010	LOD21031110	LOD21031011	LOD21031111	LOD21031012	LOD21031112
	White Pearlescent	LOD20231010	LOD20231110	LOD20231011	LOD20231111	LOD20231012	LOD20231112
		€ 8.707	€ 9.601	€ 10.600	€ 11.494	€ 10.600	€ 11.494

BLOWER

		BUILT-IN		FREESTANDING			
SKIRTING · PANNELLI				SILVERWOOD		ROASTED CHESTNUT	
INSULATION · ISOLAMENTO		Standard	Nordic	Standard	Nordic	Standard	Nordic
Electric heater Riscaldatore elettrico 3 kW	Bianco	LOD20015010	LOD20015110	LOD20015011	LOD20015111	LOD20015012	LOD20015112
	Platinum	LOD21015010	LOD21015110	LOD21015011	LOD21015111	LOD21015012	LOD21015112
	White Pearlescent	LOD20215010	LOD20215110	LOD20215011	LOD20215111	LOD20215012	LOD20215112
		€ 7.984	€ 8.878	€ 9.877	€ 10.771	€ 9.877	€ 10.771
Heat exchanger Scambiatore di calore	Bianco	LOD20011010	LOD20011110	LOD20011011	LOD20011111	LOD20011012	LOD20011112
	Platinum	LOD21011010	LOD21011110	LOD21011011	LOD21011111	LOD21011012	LOD21011112
	White Pearlescent	LOD20211010	LOD20211110	LOD20211011	LOD20211111	LOD20211012	LOD20211112
		€ 7.409	€ 8.303	€ 9.302	€ 10.196	€ 9.302	€ 10.196



LODGE L

Design Jacuzzi®

223 x 211 x 90 H cm

new

Drawing shows the HYDRO version
Disegno raffigurante la versione HYDRO

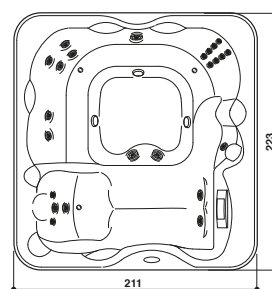

HYDRO

		BUILT-IN		FREESTANDING			
SKIRTING · PANNELLI				SILVERWOOD		ROASTED CHESTNUT	
INSULATION · ISOLAMENTO		Standard	Nordic	Standard	Nordic	Standard	Nordic
Electric heater Riscaldatore elettrico 3 kW	Bianco	LOD30025010	LOD30025110	LOD30025011	LOD30025111	LOD30025012	LOD30025112
	Platinum	LOD31025010	LOD31025110	LOD31025011	LOD31025111	LOD31025012	LOD31025112
	White Pearlescent	LOD30225010	LOD30225110	LOD30225011	LOD30225111	LOD30225012	LOD30225112
		€ 8.741	€ 9.635	€ 10.634	€ 11.528	€ 10.634	€ 11.528
Heat exchanger Scambiatore di calore	Bianco	LOD30021010	LOD30021110	LOD30021011	LOD30021111	LOD30021012	LOD30021112
	Platinum	LOD31021010	LOD31021110	LOD31021011	LOD31021111	LOD31021012	LOD31021112
	White Pearlescent	LOD30221010	LOD30221110	LOD30221011	LOD30221111	LOD30221012	LOD30221112
		€ 8.906	€ 9.800	€ 10.799	€ 11.693	€ 10.799	€ 11.693

HYDRO-BLOWER

		BUILT-IN		FREESTANDING			
SKIRTING · PANNELLI				SILVERWOOD		ROASTED CHESTNUT	
INSULATION · ISOLAMENTO		Standard	Nordic	Standard	Nordic	Standard	Nordic
Electric heater Riscaldatore elettrico 3 kW	Bianco	LOD30035010	LOD30035110	LOD30035011	LOD30035111	LOD30035012	LOD30035112
	Platinum	LOD31035010	LOD31035110	LOD31035011	LOD31035111	LOD31035012	LOD31035112
	White Pearlescent	LOD30235010	LOD30235110	LOD30235011	LOD30235111	LOD30235012	LOD30235112
		€ 9.336	€ 10.230	€ 11.229	€ 12.123	€ 11.229	€ 12.123
Heat exchanger Scambiatore di calore	Bianco	LOD30031010	LOD30031110	LOD30031011	LOD30031111	LOD30031012	LOD30031112
	Platinum	LOD31031010	LOD31031110	LOD31031011	LOD31031111	LOD31031012	LOD31031112
	White Pearlescent	LOD30231010	LOD30231110	LOD30231011	LOD30231111	LOD30231012	LOD30231112
		€ 9.501	€ 10.395	€ 11.394	€ 12.288	€ 11.394	€ 12.288

BLOWER

		BUILT-IN		FREESTANDING			
SKIRTING · PANNELLI				SILVERWOOD		ROASTED CHESTNUT	
INSULATION · ISOLAMENTO		Standard	Nordic	Standard	Nordic	Standard	Nordic
Electric heater Riscaldatore elettrico 3 kW	Bianco	LOD30015010	LOD30015110	LOD30015011	LOD30015111	LOD30015012	LOD30015112
	Platinum	LOD31015010	LOD31015110	LOD31015011	LOD31015111	LOD31015012	LOD31015112
	White Pearlescent	LOD30215010	LOD30215110	LOD30215011	LOD30215111	LOD30215012	LOD30215112
		€ 8.648	€ 9.542	€ 10.541	€ 11.435	€ 10.541	€ 11.435
Heat exchanger Scambiatore di calore	Bianco	LOD30011010	LOD30011110	LOD30011011	LOD30011111	LOD30011012	LOD30011112
	Platinum	LOD31011010	LOD31011110	LOD31011011	LOD31011111	LOD31011012	LOD31011112
	White Pearlescent	LOD30211010	LOD30211110	LOD30211011	LOD30211111	LOD30211012	LOD30211112
		€ 8.073	€ 8.967	€ 9.966	€ 10.860	€ 9.966	€ 10.860



THE PROFESSIONAL COLLECTION





VIRTUS PRO

Design Dodo Arslan e Jacuzzi® Design

250 x 215 x 93 H cm

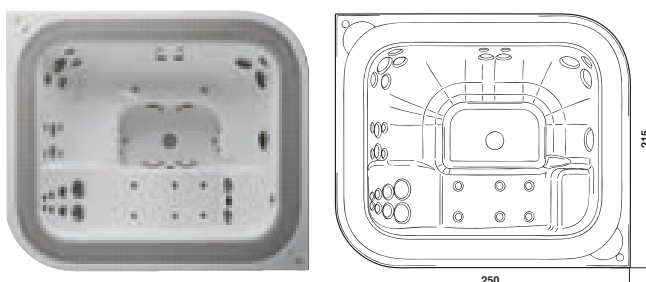

FEATURES · DOTAZIONI

	Seats (total) · Sedute (totali)	6-7
	Lounge	1
	PowerPro® Jets · Bocchette PowerPro®	50
	Light System - Multicolor	2
	LED control panel · Pannello comandi LED	✓
	Back-lit touch controls · Comandi Touch retroilluminati	2
	Automatic water fill-up · Rabocco acqua automatico	✓
	Quick drain · Svuotamento rapido	✓
	Smart Access Door · Pannello "Smart Access"	○
	Eco shield insulation · Isolamento Eco Shield	○
	Thermal cover in two folding parts Copertura termica in due parti pieghevoli	Marine-grade fabric Tessuto nautico
		GREY

COLOURS · COLORI

	52	65	52	65
--	-----------	-----------	-----------	-----------

INSULATION · ISOLAMENTO

		STANDARD		ECO SHIELD	
With integrated compensation tanks Con vasche di compensazione integrate	Built-in	VIR00020040	VIR01020040		
		€ 16.735			
	Freestanding	TEAK GRAPHITE	VIR00020043 VIR00020044	VIR01020043 VIR01020044	VIR00020343 VIR00020344
		€ 19.735		€ 20.255	
With low compensation tank Con vasca di compensazione bassa	Built-in	VIR00020030	VIR01020030		
		€ 17.765			
	Freestanding	TEAK GRAPHITE	VIR00020033 VIR00020034	VIR01020033 VIR01020034	VIR00020333 VIR00020334
		€ 20.765		€ 21.285	
With standard compensation tank Con vasca di compensazione standard	Built-in	VIR00020020	VIR01020020		
		€ 16.625			
	Freestanding	TEAK GRAPHITE	VIR00020023 VIR00020024	VIR01020023 VIR01020024	VIR00020323 VIR00020324
		€ 19.625		€ 20.145	
Without compensation tank Senza vasca di compensazione	Built-in	VIR00020000	VIR01020000		
		€ 15.150			
	Freestanding	TEAK GRAPHITE	VIR00020003 VIR00020004	VIR01020003 VIR01020004	VIR00020303 VIR00020304
		€ 18.150		€ 18.670	

SPA PACK

		EUROPEAN STANDARD 220/240V F+N - OTHERS 380/415V 3F+N	
	Without heater · Senza riscaldatore	94428780	
		€ 4.345	
	With heater · Con riscaldatore	3 kW	94428790
Exchanger · Scambiatore		94428800	€ 4.880
		EUROPEAN STANDARD 380/415V 3F+N	
	Without heater · Senza riscaldatore	94428100	OTHERS 220/240V 3F
		€ 5.265	
	With heater · Con riscaldatore	12 kW	94428101
Exchanger · Scambiatore		94428102	94427102
		€ 5.685	

OPTIONAL

	Ozone generator Generatore ozono	94360040
		€ 692
	SPA PACK booster kit	94428700
		€ 6.955

✓ Standard ○ Depending on the version ✓ Standard ○ A seconda della versione

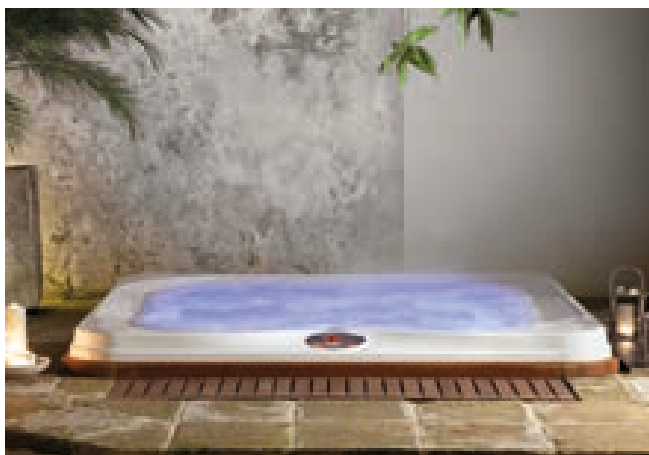

PROFILE PRO

Jacuzzi® Design

235/239 x 211/215 x 93 H cm

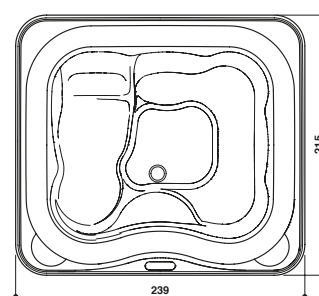

FEATURES · DOTAZIONI

	BASE	TOP
Seats (total) Sedute (totali)	5-6	
Lounge	1	
PowerPro® Jets Bocchette PowerPro®	31	
Blowers	14	
Light System - Multicolor	✓	
Automatic water fill-up Rabbocco acqua automatico	✓	
Aromatherapy Aromaterapia	✓	
Insound System Wireless	✓	
Insulating cover Copertura termica	✓	

COLOURS · COLORI

	52 65 97					
	BUILT-IN	GRAPHITE	TEAK	BUILT-IN	GRAPHITE	TEAK
With integrated compensation tank Con vasca di compenso integrata	9445369*	9445368*	9445479*	9445371*	9445370*	9445480*
	€ 12.502	€ 15.286	€ 15.286	€ 13.763	€ 16.357	€ 16.357

SPA PACK

			EUROPEAN STANDARD 220/240V F+N - OTHERS 380/415V 3F+N	
Single-phase Monofase	Without heater Senza riscaldatore		94428730	
	With heater Con riscaldatore	3 kW	€ 6.023	
	Exchanger Scambiatore		94428710	
			€ 6.375	
			94428720	
			€ 6.726	
Three-phase Trifase	Without heater Senza riscaldatore		EUROPEAN STANDARD 380/415V 3F+N	OTHERS 220/240V 3F
	With heater Con riscaldatore	12 kW	94428400	94427400
	Exchanger Scambiatore		94428401	94427401
			€ 7.740	
			94428402	94427402
			€ 7.804	

OPTIONAL

Ozone generator Generatore ozono	94360040
	€ 692
SPA PACK booster kit	94428700
	€ 6.955

Always indicate the SPA PACK code when ordering.

Indicare sempre nell'ordine il codice dello SPA PACK.



ENJOY

Design Kaluderovic & Condini

250 x 250 x 98 H cm

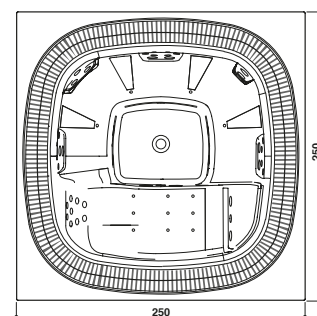

FEATURES · DOTAZIONI

		BASE	TOP
	Seats (total) · Sedute (totali)	6	6
	Lounge	1	1
	PowerPro® Jets · Bocchette PowerPro®	18	38
	Blowers		15
	Light System - Multicolor	1	2
	Automatic water fill-up · Rabbocco acqua automatico	✓	✓
	Aromatherapy · Aromaterapia		✓
	Insulating cover · Copertura termica	Vinyl leatherette Vinilpelle	ICE

COLOURS · COLORI

		52	65	97
		BASE	TOP	
	Standard packing Imballo standard	With low compensation tank Con vasca di compenso ribassata	9445022*	9445025*
			€ 13.642	€ 15.346
		With standard compensation tank Con vasca di compenso standard	9445021*	9445-024*
		€ 12.504	€ 14.210	
		9445023*	9445026*	
		€ 11.029	€ 12.734	

SPA PACK

		EUROPEAN STANDARD	220/240V F+N	220/240V F+N
		OTHERS	380/415V 3F+N	380/415V 3F+N
	Without heater Senza riscaldatore		94428760	94428730
			€ 4.285	€ 6.023
	With heater Con riscaldatore	3 kW	94428740	9442-8710
			€ 4.636	€ 6.375
	Exchanger Scambiatore	94428750	94428720	
		€ 4.987	€ 6.726	
			BASE	TOP
			EUROPEAN STANDARD 380/415V 3F+N	OTHERS 220/240V 3F
	Without heater Senza riscaldatore		94428400	94427400
			€ 6.417	
	With heater Con riscaldatore	12 kW	94428401	94427401
			€ 7.740	
	Exchanger Scambiatore	94428402	94427402	
			€ 7.804	

OPTIONAL

	Ozone generator Generatore ozono	94360040
		€ 692
	SPA PACK booster kit	94428700
		€ 6.955

Always indicate the SPA PACK code when ordering.

Indicare sempre nell'ordine il codice dello SPA PACK.



VIRGINIA EXPERIENCE

Jacuzzi® Design

257 x 219 x 98 H cm

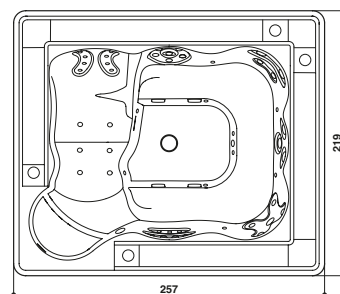

FEATURES · DOTAZIONI

	Seats (total) Sedute (totali)		6-7
	Lounge		1
	PowerPro® Jets Bocchette PowerPro®		34
	Blowers		16
	Coloured Light System		✓
	Automatic water fill-up Rabbocco acqua automatico		✓
	Aromatherapy Aromaterapia		✓
	Insulating cover Copertura termica	Vinyl leatherette Vinilpelle	ICE

COLOURS · COLORI

			52 65 97
	Standard packing Imballo standard		With low compensation tank Con vasca di compenso ribassata
			9445042* € 17.275
			With standard compensation tank Con vasca di compenso standard
			9445014* € 16.138
			9445017* € 14.663

SPA PACK

			EUROPEAN STANDARD 220/240V F+N	
			OTHERS 380/415V 3F+N	
	Single-phase Monofase	Without heater Senza riscaldatore	94428730	
		With heater Con riscaldatore	€ 6.023	
		Exchanger Scambiatore	94428710	3 kW
			€ 6.375	
			94428720	
			€ 6.726	
	Three-phase Trifase	Without heater Senza riscaldatore	EUROPEAN STANDARD 380/415V 3F+N	OTHERS 220/240V 3F
			94428400	94427400
		With heater Con riscaldatore	€ 6.417	
		Exchanger Scambiatore	94428401	12 kW
			€ 7.740	94427401
		94428402	94427402	
			€ 7.804	

OPTIONAL

	Ozone generator Generatore ozono	94360040
		€ 692
	SPA PACK booster kit	94428700
		€ 6.955

Always indicate the SPA PACK code when ordering.

Indicare sempre nell'ordine il codice dello SPA PACK.



SIENNA EXPERIENCE

Jacuzzi® Design

257 x 219 x 98 H cm

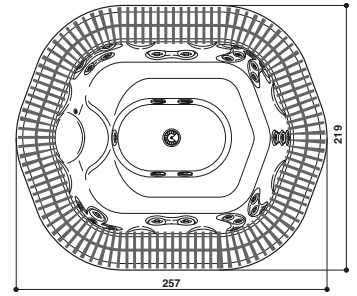

FEATURES · DOTAZIONI

	Seats (total) Sedute (totali)		7-8
	PowerPro® Jets Bocchette PowerPro®		30
	Blowers		16
	Coloured Light System		✓
	Automatic water fill-up Rabbocco acqua automatico		✓
	Aromatherapy Aromaterapia		✓
	Insulating cover Copertura termica	Vinyl leatherette Vinilpelle	ICE

COLOURS · COLORI

			52 65 97
	Standard packing Imballo standard		With low compensation tank Con vasca di compenso ribassata
			With standard compensation tank Con vasca di compenso standard
			With standard compensation tank Con vasca di compenso standard

SPA PACK

				EUROPEAN STANDARD 220/240V F+N	
				OTHERS 380/415V 3F+N	
	Single-phase Monofase	Without heater Senza riscaldatore		94428730	
		With heater Con riscaldatore	3 kW	94428710	
		Exchanger Scambiatore		94428720	
				EUROPEAN STANDARD 380/415V 3F+N	OTHERS 220/240V 3F
	Three-phase Trifase	Without heater Senza riscaldatore		94428400	94427400
		With heater Con riscaldatore	12 kW	94428401	94427401
		Exchanger Scambiatore		94428402	94427402
				€ 6.417	€ 7.804

OPTIONAL

	Ozone generator Generatore ozono		94360040
			€ 692
	SPA PACK booster kit		94428700
			€ 6.955

Always indicate the SPA PACK code when ordering.

Indicare sempre nell'ordine il codice dello SPA PACK.



ALIMIA EXPERIENCE

Jacuzzi® Design

Ø 237 x 98 H cm

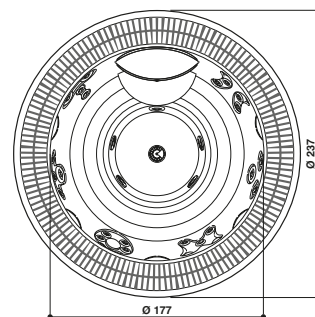

FEATURES · DOTAZIONI

	Seats (total) Sedute (totali)		6-7
	PowerPro® Jets Bocchette PowerPro®		28
	Blowers		16
	Coloured Light System		✓
	Automatic water fill-up Rabbocco acqua automatico		✓
	Aromatherapy Aromaterapia		✓
	Insulating cover Copertura termica	Vinyl leatherette Vinilpelle	ICE

COLOURS · COLORI

			52	65	97
	Standard packing Imballo standard		With low compensation tank Con vasca di compenso ribassata	9445043*	€ 16.586
			With standard compensation tank Con vasca di compenso standard	9445016*	€ 15.449
			With standard compensation tank Con vasca di compenso standard	9445018*	€ 13.974
	Packing for container Imballo per container		With low compensation tank Con vasca di compenso ribassata	9445044*	€ 17.025
			With standard compensation tank Con vasca di compenso standard	9445033*	€ 15.888
			With standard compensation tank Con vasca di compenso standard	9445034*	€ 14.412

SPA PACK

			EUROPEAN STANDARD 220/240V F+N	
			OTHERS 380/415V 3F+N	
	Single-phase Monofase	Without heater Senza riscaldatore	94428730	€ 6.023
		With heater Con riscaldatore	94428710	€ 6.375
		Exchanger Scambiatore	94428720	€ 6.726
			EUROPEAN STANDARD 380/415V 3F+N	OTHERS 220/240V 3F
	Three-phase Trifase	Without heater Senza riscaldatore	94428400	94427400
		With heater Con riscaldatore	94428401	94427401
		Exchanger Scambiatore	94428402	94427402

OPTIONAL

	Ozone generator Generatore ozono	94360040	€ 692
	SPA PACK booster kit	94428700	€ 6.955

Always indicate the SPA PACK code when ordering.

Indicare sempre nell'ordine il codice dello SPA PACK.



THE SWIM SPA COLLECTION





PowerPro™ J-19

Design Jacuzzi®

564 x 236 x 134 H
cm



FEATURES · DOTAZIONI

	PowerPro® Swim PX Jets Bocchette PowerPro® Swim PX		2
	Buoyancy Jet Bocchetta di galleggiamento		1
	Swim Selector Control Comando Swim Selector		1
	Hydromassage seats Sedute idromassaggio		4
	PowerPro® Jets Bocchette PowerPro®		28
	Swim Spa Water Watch Orologio Water Watch per Swim Spa		✓
	WaterColour™ Waterfall Cascata WaterColour™		✓
	Light System LED Multicolour Illuminazione subacquea LED multicolore		✓
	CLEARRAY® PRO3TECT™ UV-C + Low output ozone generator UV-C + Ozonizzatore a bassa emissione		✓
	Pillow headrest Poggiatesta		2
	Perma insulated floor Base con isolamento termico		✓
	Insulating hard cover Copertura rigida isolante	Vinyl leatherette Vinilpelle	SILVERWOOD
	Skirting Pannelli		SILVERWOOD/BLACK
		SILVER PEARL	SC333UGEGO
		PORCELAIN	SC763UGEGO
		PLATINUM	SC123UGEGO
			€ 35.520

ACCESSORIES · ACCESSORI

	Aqua Fitness Package: dumbbells, paddles, gloves, noodle, resistance band, floating belt Kit Aqua Fitness: manubri, pagaie a elica, guanti, cilindro, elastico tubolare con maniglie, cintura galleggiante	130396870	€ 559
	Swim Spa Water Watch (additional) Orologio Water Watch per swim spa (aggiuntivo)	890011220	€ 549
	Float cover Copertura galleggiante	890011210	€ 380
	Swim Spa Stair (black) Scala Swim Spa (nera)	890011080	€ 1.408

ON DEMAND · SU RICHIESTA

	Stainless steel exercise bar 120 cm (left side only - factory fitted) Barra per esercizi in acciaio inox 120 cm (solo lato sinistro - preinstallato)		+ € 550
	Swim Spa with Rowing Kit (factory fitted) Swim Spa con kit vogatore (preinstallato)		+ € 1.465



PowerPro™ J-16

Design Jacuzzi®

472 x 236 x 134 H cm

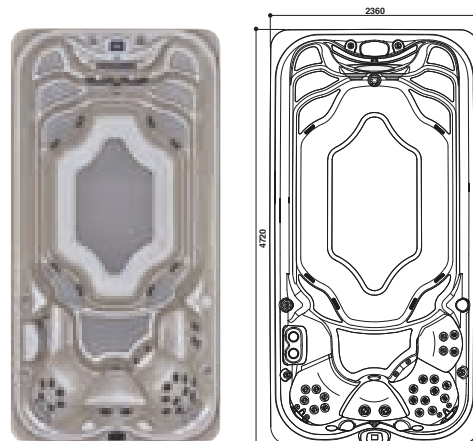

FEATURES · DOTAZIONI

	PowerPro® Swim PX Jets Bocchette PowerPro® Swim PX		2
	Buoyancy Jet Bocchetta di galleggiamento		1
	Swim Selector Control Comando Swim Selector		1
	Hydromassage seats Sedute idromassaggio		4
	PowerPro® Jets Bocchette PowerPro®		28
	Swim Spa Water Watch Orologio Water Watch per Swim Spa		✓
	WaterColour™ Waterfall Cascata WaterColour™		✓
	Light System LED Multicolour Illuminazione subacquea LED multicolore		✓
	CLEARRAY® PRO3TECT™ UV-C + Low output ozone generator UV-C + Ozonizzatore a bassa emissione		✓
	Pillow headrest Poggiatesta		2
	Perma insulated floor Base con isolamento termico		✓
	Insulating hard cover Copertura rigida isolante	Vinyl leatherette Vinilpelle	SILVERWOOD
	Skirting Pannelli		SILVERWOOD/BLACK
		SILVER PEARL	SJ333UGEGQ
		PORCELAIN	SJ763UGEGQ
		PLATINUM	SJ123UGEGQ
			€ 31.350

ACCESSORIES · ACCESSORI

	Aqua Fitness Package: dumbbells, paddles, gloves, noodle, resistance band, floating belt Kit Aqua Fitness: manubri, pagaie a elica, guanti, cilindro, elastico tubolare con maniglie, cintura galleggiante	130396870
		€ 559
	Swim Spa Water Watch (additional) Orologio Water Watch per swim spa (aggiuntivo)	890011220
		€ 549
	Float cover Copertura galleggiante	890011210
		€ 380
	Swim Spa Stair (black) Scala Swim Spa (nera)	890011080
		€ 1.408

ON DEMAND · SU RICHIESTA

	Stainless steel exercise bar 120 cm (left side only - factory fitted) Barra per esercizi in acciaio inox 120 cm (solo lato sinistro - preinstallato)	+ € 550
	Swim Spa with Rowing Kit (factory fitted) Swim Spa con kit vogatore (preinstallato)	+ € 1.465

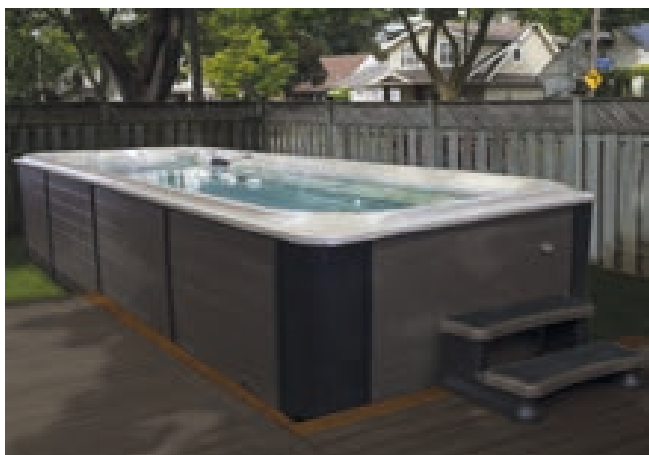

PowerActive™ J-19

Design Jacuzzi®

564 x 236 x 134 H
cm

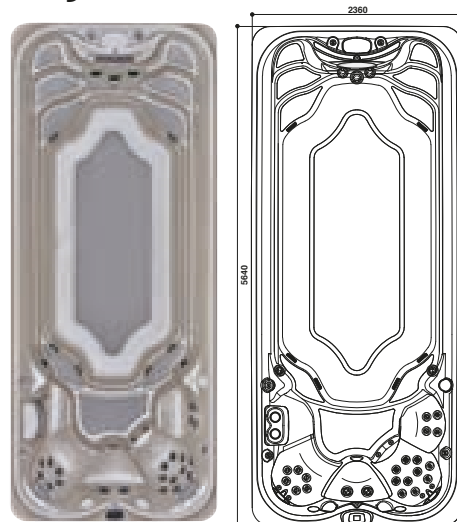

FEATURES · DOTAZIONI

	PowerPro® Swim PX Jets Bocchette PowerPro® Swim PX		2
	Buoyancy Jet Bocchetta di galleggiamento		1
	Swim Selector Control Comando Swim Selector		1
	Hydromassage seats Sedute idromassaggio		4
	PowerPro® Jets Bocchette PowerPro®		28
	Swim Spa Water Watch Orologio Water Watch per Swim Spa		✓
	WaterColour™ Waterfall Cascata WaterColour™		✓
	Light System LED Multicolour Illuminazione subacquea LED multicolore		✓
	CLEARRAY® PRO3TECT™ UV-C + Low output ozone generator UV-C + Ozonizzatore a bassa emissione		✓
	Pillow headrest Poggiatesta		2
	Perma insulated floor Base con isolamento termico		✓
	Insulating hard cover Copertura rigida isolante	Vinyl leatherette Vinilpelle	SILVERWOOD
	Skirting Pannelli		SILVERWOOD/BLACK
		SILVER PEARL	SF333UGEGQ
		PORCELAIN	SF763UGEGQ
		PLATINUM	SF123UGEGQ
			€ 31.350

ACCESSORIES · ACCESSORI

	Aqua Fitness Package: dumbbells, paddles, gloves, noodle, resistance band, floating belt Kit Aqua Fitness: manubri, pagaie a elica, guanti, cilindro, elastico tubolare con maniglie, cintura galleggiante	130396870	€ 559
	Swim Spa Water Watch (additional) Orologio Water Watch per swim spa (aggiuntivo)	890011220	€ 549
	Float cover Copertura galleggiante	890011210	€ 380
	Swim Spa Stair (black) Scala Swim Spa (nera)	890011080	€ 1.408

ON DEMAND · SU RICHIESTA

	Stainless steel exercise bar 120 cm (left side only - factory fitted) Barra per esercizi in acciaio inox 120 cm (solo lato sinistro - preinstallato)		+ € 550
	Swim Spa with Rowing Kit (factory fitted) Swim Spa con kit vogatore (preinstallato)		+ € 1.465



PowerActive™ J-16

Design Jacuzzi®

472 x 236 x 134 H cm

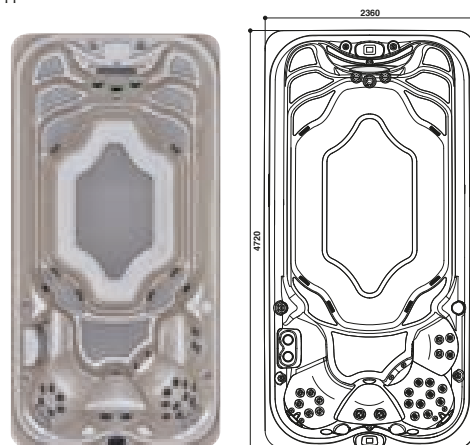

FEATURES · DOTAZIONI

	PowerPro® Swim PX Jets Bocchette PowerPro® Swim PX		2
	Buoyancy Jet Bocchetta di galleggiamento		1
	Swim Selector Control Comando Swim Selector		1
	Hydromassage seats Sedute idromassaggio		4
	PowerPro® Jets Bocchette PowerPro®		28
	Swim Spa Water Watch Orologio Water Watch per Swim Spa		✓
	WaterColour™ Waterfall Cascata WaterColour™		✓
	Light System LED Multicolour Illuminazione subacquea LED multicolore		✓
	CLEARRAY® PRO3TECT™ UV-C + Low output ozone generator UV-C + Ozonizzatore a bassa emissione		✓
	Pillow headrest Poggiatesta		2
	Perma insulated floor Base con isolamento termico		✓
	Insulating hard cover Copertura rigida isolante	Vinyl leatherette Vinilpelle	SILVERWOOD
	Skirting Pannelli		SILVERWOOD/BLACK
		SILVER PEARL	SM333UGEGO
		PORCELAIN	SM763UGEGO
		PLATINUM	SM123UGEGO
			€ 27.600





ACCESSORIES · ACCESSORI

	Aqua Fitness Package: dumbbells, paddles, gloves, noodle, resistance band, floating belt Kit Aqua Fitness: manubri, pagaie a elica, guanti, cilindro, elastico tubolare con maniglie, cintura galleggiante	130396870
		€ 559
	Swim Spa Water Watch (additional) Orologio Water Watch per swim spa (aggiuntivo)	890011220
		€ 549
	Float cover Copertura galleggiante	890011210
		€ 380
	Swim Spa Stair (black) Scala Swim Spa (nera)	890011080
		€ 1.408

ON DEMAND · SU RICHIESTA

	Stainless steel exercise bar 120 cm (left side only - factory fitted) Barra per esercizi in acciaio inox 120 cm (solo lato sinistro - preinstallato)	+ € 550
	Swim Spa with Rowing Kit (factory fitted) Swim Spa con kit vogatore (preinstallato)	+ € 1.465

ACCESSORIES SWIM SPA ACCESSORI SWIM SPA

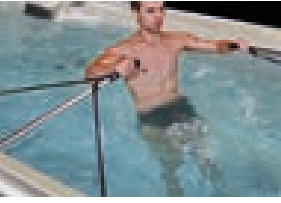
	Description Descrizione	Dimensions Dimensioni	Code Codice
	Swim Spa stairs 4 steps (black) Scala 4 gradini Swim Spa (nero)	88 x 148 x 66/167 H cm	890011080 € 1.408
	Aqua Fitness Package: dumbbells, paddles, gloves, noodle, resistance band, floating belt Kit Aqua Fitness: manubri, pagaie a elica, guanti, cilindro, elastico tubolare con maniglie, cintura galleggiante		130396870 € 559
	Swim Spa Water Watch (additional) Orologio Water Watch per swim spa (aggiuntivo)		890011220 € 549
	Float cover Copertura galleggiante	J-19	890011210 € 380
		J-16	890011240 € 450
	Stainless steel exercise bar 120 cm (left side only) Barra per esercizi in acciaio inox 120 cm (solo lato sinistro)	Factory fitted Preinstallato	+ € 550
	Swim Spa with rowing kit Swim Spa con kit vogatore	Factory fitted Preinstallato	+ € 1.465

SWIM SPA + ROWING KIT

	SILVER PEARL	PORCELAIN	PLATINUM
POWER PRO J-19	SC333UGEGOW	SC763UGEGOW	SC123UGEGOW
	€ 36.985		
POWER PRO J-16	SJ333UGEGOW	SJ763UGEGOW	SJ123UGEGOW
	€ 32.815		
POWER ACTIVE J-19	SF333UGEGOW	SF763UGEGOW	SF123UGEGOW
	€ 32.815		
POWER ACTIVE J-16	SM333UGEGOW	SM763UGEGOW	SM123UGEGOW
	€ 29.065		

OUTDOOR SHOWER COLUMN COLONNA DOCCIA PER ESTERNO

Design Nespoli_Novara - Design Jacuzzi®

new

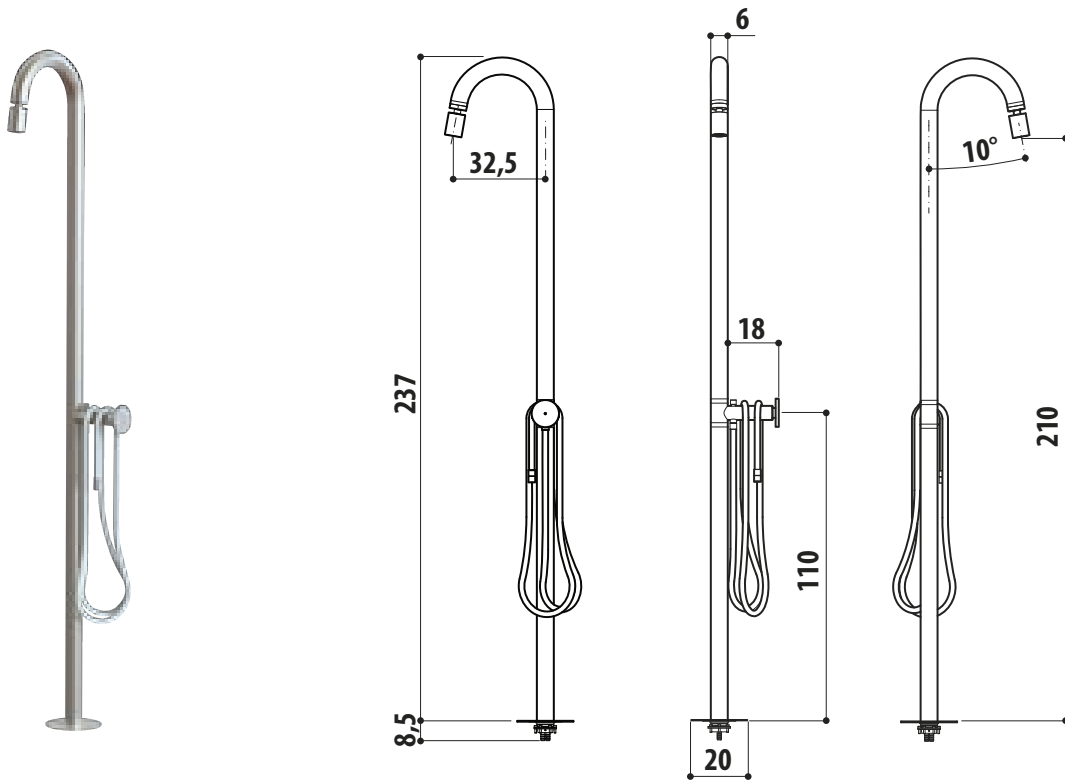

Description Descrizione	Dimensions Dimensioni	Code Codice
<p>Outdoor shower column, matte stainless steel 316L with progressive single-lever mixer (cold-hot water) and grey silicone rubber hose.</p> <p>Colonna doccia per esterno in acciaio inox 316L satinato con miscelatore monocomando progressivo (acqua fredda-calda) e flessibile in gomma silconica di colore grigio.</p>	<p>Ø 6 x 237 H cm</p>	<p>228501130</p> <p>€ 2.780</p>
<p>Recessed body for outdoor shower column (to be paired with code 228501130)</p> <p>Corpo incasso per colonna doccia per esterno (da abbinare al codice 228501130)</p>	<p>Ø 20 x 8,5 H cm</p>	<p>228501150</p> <p>€ 190</p>





ACCESSORIES SPA ACCESSORI SPA

	Description Descrizione	Dimensions Dimensioni	Finishing Finitura	Code Codice
	J-500™ Curvalux™ stairs - 2 steps Scala Curvalux™ - 2 gradini		SILVERWOOD	890010830
			ROASTED CHESTNUT	890010840
€ 932				
	J-400™ J-300™ ProFinish™ steps Gradino ProFinish™	81,5 x 50,5 x 38 H cm	MODERN HARDWOOD	890011170
			SMOKED EBONY	890011180
			BRUSHED GREY	890011190
€ 605				
	ProEndure™ stairs - 2 steps Scala ProEndure™ - 2 gradini	81,3 x 55,9 x 35,6 H cm	SILVERWOOD	890010590
			BRAZILIAN TEAK	890010600
			ROASTED CHESTNUT	890010640
€ 737				
	Synthetic wood stairs - 2 steps Scala in legno sintetico - 2 gradini	81,3 x 55,9 x 35,6 H cm	BLACK	890010810
€ 348				
	ProEndure™ stairs - 1 steps Scala ProEndure™ - 1 gradino	76,2 x 29,2 x 17,8 H cm	SILVERWOOD	890010610
			ROASTED CHESTNUT	890010620
			BRAZILIAN TEAK	890010630
€ 454				
	Synthetic wood stairs - 1 step Scala in legno sintetico - 1 gradino	76,2 x 29,2 x 17,8 H cm	BLACK	890010820
€ 198				
	JLX™ ProStep™ stairs Scala ProStep™		ROASTED CHESTNUT	890010690
			BRAZILIAN TEAK	890010680
€ 1.214				

* Included with the synthetic step is the LED light kit.
Spas that were manufactured before 06/06/11 are not "light kit ready" and require a retrofit kit.

* Scala con kit Luci a LED incluso.
Le spa fabbricate prima del 06/06/11 non sono allestite con connessione luci e necessitano un kit dedicato.

	Description Descrizione	Dimensions Dimensioni	Finishing Finitura	Code Codice
	Okoumé Wood, stairs - 2 step Scala in legno di Okoumé, 2 gradini	82 x 50 x 40 H cm	TEAK	890000370
				€ 551
	PROLAST™ Spa Side Umbrella Ombrellone laterale spa PROLAST™	300/350 x 260 H cm	BLACK	890010860
			GREY	890010870
			SIENNA	890010880
				€ 847
	SPA BOOST Cushion Cuscino SPA BOOST			890010010
				€ 95
	SPA access bar handle Maniglione ingresso SPA	890010100		890010100
				€ 253
	J-500™ Covermate with pistons Sollevatore con pistoni per copertura termica			890010770
				€ 848
	J-495™ Covermate with pistons Sollevatore con pistoni per copertura termica			890010710
				€ 803
	J-485™ · J-475™ · J-445™ · J-435™ Covermate with pistons Sollevatore con pistoni per copertura termica			890011160
				€ 699
	J-425™ Covermate with pistons Sollevatore con pistoni per copertura termica			890010360
				€ 679
	J-415™ Covermate with pistons Sollevatore con pistoni per copertura termica			890010760
				€ 482
	J-300™ Covermate with pistons Sollevatore con pistoni per copertura termica			890011260
				€ 699
	J-LX™ - LODGE - PROFILE - PROFILE PRO Covermate by hand Sollevatore manuale per copertura termica			890010780
				€ 506



INSULATING COVER COPERTURE TERMICHE

Model Modello	Material Materiale	Finishing Finitura
J-500™ J-400™ J-300™	PROLAST™ All-weather marine-grade fabric Tessuto nautico	GREY standard SIENNA on demand · su richiesta BLACK on demand · su richiesta
J-LXL®	Vinyl leatherette Vinilpelle	BORDEAUX
Virtus - Virtus Pro	All-weather marine-grade fabric Tessuto nautico	GREY
Flow	Vinyl leatherette Vinilpelle	PLATIN
Unique	All-weather marine-grade fabric Tessuto nautico	ICE
PROFESSIONAL except Profile Pro DESIGN COLLECTION except Flow, Virtus Pro, Profile Pro	Vinyl leatherette Vinilpelle	ICE
Lodge S - M - L Profile Pro	Vinyl leatherette Vinilpelle	SILVERWOOD

Model Modello	Material Materiale	Finshing Finitura	Code Codice	Price Prezzo
J-585™ · J-575™	PROLAST™	Grey	903001990	€ 1.376
		Sienna	903002000	
new J-495™	PROLAST™	Grey	903002070	€ 1.557
J-485™ · J-475™	PROLAST™	Grey	903002740	€ 1.145
J-445™ · J-435™	PROLAST™	Grey	903002350	€ 1.076
new J-425™	PROLAST™	Grey	903002750	€ 1.032
new J-385™ · J-375™	PROLAST™	Grey	903002300	€ 1.159
new J-365™ · J-355™	PROLAST™	Grey	903002610	€ 1.110
new J-345™ · J-335™	PROLAST™	Grey	903002180	€ 1.083
new J-325™	PROLAST™	Grey	903003100	€ 1.032
new J-315™	PROLAST™	Grey	903003110	€ 935
J-LXL™	Vinyl leatherette Vinilpelle	Bordeaux	903001590	€ 922
ALIMIA	Vinyl leatherette Vinilpelle	Ice	903001710	€ 917
ALIMIA XP	Vinyl leatherette Vinilpelle	Ice	903001670	€ 1.027
CITY™	Vinyl leatherette Vinilpelle	Ice	903001730	€ 685
DELFI - DELFI PRO - DELFI PRO SOUND	Vinyl leatherette Vinilpelle	Ice	903001560	€ 857
DELOS - DELOS PRO DELOS PRO SOUND	Vinyl leatherette Vinilpelle	Ice	903001540	€ 911
ENJOY	Vinyl leatherette Vinilpelle	Ice	903001870	€ 1.285
FLOW	Vinyl leatherette Vinilpelle	Platin	903001850	€ 857
FLOW protective cover sheet - cuffia protettiva	Marine grade fabric Tessuto nautico	White - Bianco	903001880	€ 857
LODGE L	Vinyl leatherette Vinilpelle	Silverwood	903001970	€ 1.038
LODGE M	Vinyl leatherette Vinilpelle	Silverwood	903001900	€ 920
LODGE S	Vinyl leatherette Vinilpelle	Silverwood	903001980	€ 735
OXIA	Vinyl leatherette Vinilpelle	Ice	903001700	€ 660
PROFILE	Vinyl leatherette Vinilpelle	Ice	903001690	€ 1.014
PROFILE PRO	Vinyl leatherette Vinilpelle	Silverwood	903001690	€ 1.014
SANTORINI PRO SANTORINI PRO SOUND	Vinyl leatherette Vinilpelle	Ice	903001480	€ 1.103
SIENNA XP	Vinyl leatherette Vinilpelle	Ice	903001660	€ 1.027
UNIQUE sunbed/prendisole	Marine grade fabric Tessuto nautico	Ice	903001410	€ 1.605
UNIQUE	Vinyl leatherette Vinilpelle	Ice	903001680	€ 741
VIRGINIA XP	Vinyl leatherette Vinilpelle	Ice	903001650	€ 1.093
VIRTUS - VIRTUS PRO	Marine grade fabric Tessuto nautico	Grey	903002470	€ 1.685

GENERAL TERMS OF SALE

These sale conditions cancel and replace all previous ones

Art. 1 General provisions

1.1. The current general terms, except for any exceptions specifically agreed in writing, enforce all current and future sales contracts between parties.

Art. 2 Formation and purpose of the contract

2.1. Jacuzzi Europe S.p.A. is committed to each order only after its acceptance in writing. Acceptance of the order by Jacuzzi Europe S.p.A. can also lead to its execution.

Art. 3 Delivery

3.1. Except for other written agreement, delivery is "Ex-works" Valvasone (Pn) – Italy. If the purchaser (retailer) does not provide for collection of goods, Jacuzzi Europe S.p.A. will have the right to entrust a reliable carrier with transport. In the event of non-collection the purchaser (retailer) will be bound to pay stock expenses.

3.2. The delivery terms agreed are indicative. In the event of delays, the purchaser (retailer), therefore, will not be able to forward any claim for compensation for damages.

Art. 4 Packaging

4.1. The packaging of appliances conforms to international transport norms carried out by land using motor vehicles. Non-standard packaging will entail an extra charge and will be agreed at the time of order.

Art. 5 Cancellation of orders

5.1. The purchaser's (retailer's) order constitutes a firm purchasing proposal. No order can be cancelled without the written consent of Jacuzzi Europe S.p.A. In the event of cancellation of orders, Jacuzzi Europe S.p.A. also reserves the right to demand compensation for damages.

Art. 6 Design – Technical data

6.1. Jacuzzi Europe S.p.A. reserves the right to stop, without warning, the manufacture of any model and to alter models during production, with no obligation to carry out the same modifications to previously sold products.

6.2. The data and features in the Jacuzzi Europe S.p.A. technical and publicity documentation (catalogues, handbooks, publicity brochures, illustrations, price lists) are subject to modifications and are not binding.

Art. 7 Prices

7.1. Prices, excluding VAT, are those stated on the price lists in force at the time of ordering and refer to goods with delivery "Ex-works" Valvasone (Pn) – Italy, unless otherwise agreed.

7.2. Prices, quotations and discounts are subject to variation without the obligation of forewarning on the part of Jacuzzi Europe S.p.A.

7.3. All orders received after modification of price lists, as well as planned consignments after thirty days from notification of the variation, are subject to the new prices.

Art. 8 Payment

8.1. Payment of goods is considered validly made only when Jacuzzi Europe S.p.A. has been credited with the relative amounts.

8.2. Any delay or irregularity in payment gives Jacuzzi Europe S.p.A. the right to suspend supplies or to annul current contracts, even if they do not pertain to the payments in question, and also the right to compensation for any damage (including that related to currency devaluation). Jacuzzi Europe S.p.A. has the right in each case – starting from the expiry date of payment, without the need of a default action – to legal interest, which will be increased by 5 (five) points.

8.3. The purchaser (retailer) is bound to full payment also in the event of dispute or controversy. Compensation with possible credit claims from Jacuzzi Europe S.p.A. is not permitted without written authorization.

8.4. In the event of non-payment, even if only partial, Jacuzzi Europe S.p.A. has the right – at its discretion – to demand from the purchaser (retailer) payment of the full sum stated in the contract or to declare the contract null and void, with the right to obtain the return of the delivered goods and to withhold, as compensation for damages, the amounts collected up to that moment, except for any other action for greater damage.

Art. 9 Property reservation

9.1. In the event that full or part payment must be made after delivery, the delivered products remain the property of Jacuzzi Europe S.p.A. until the moment of full payment of the price, according to the provisions of art. 1523 of the Civil Code.

9.2. As provided by the aforesaid property reservation, Jacuzzi Europe S.p.A. will have the right to proceed with the collection of any unpaid goods; in which case all related costs will be at the expense of the purchaser (retailer) and Jacuzzi Europe S.p.A. will be able to withhold any amounts already collected as compensation for damage. If the purchaser (retailer) has resold the goods to third parties, the rights laid claim to by Jacuzzi Europe S.p.A., as provided in the present clause, will refer to the price obtained from the sale of the same goods.

Art. 10 Circumstances beyond control and excessive onerousness

10.1. Events constituting cases of exemption from responsibility are fires, collapse, floods, non-delivery of supplies, transport difficulties, strikes, closures or other events due to circumstances beyond control, which impede or considerably reduce production by Jacuzzi Europe S.p.A. or its suppliers, or seriously hinder transport of the sold goods. Annulment of the contract and also the provision of other solutions that are different from the claim for compensation for damages, are only permitted for impediments that continue for at least 60 days.

10.2. If the fulfillment of obligations, before their execution, by Jacuzzi Europe S.p.A. is considered excessively onerous, for any unexpected reason by a trader with normal experience in this sector – with regard to the original agreement thus altering the ratio itself by 20% or more – Jacuzzi Europe S.p.A. will be able to request a review of contractual terms or, in the event of non-agreement, declare the contract null and void.

Art. 11 Claims

11.1. The purchaser (retailer) is bound to declare any damage to the product, or non-conformity in delivery that could be discovered when in possession of the goods, in specific detail in writing otherwise the claim will be null and void. This must be within and no more than 8 days from the time the goods were made available.

11.2. Any defects in conformity that are not identified following a check of the goods as in paragraph 11.1 must be declared by the purchaser, or will be null and void, not later than the time provided by law. This starts from the moment the goods themselves were made available to the purchaser.

Art. 12 Guarantee

12.1. In agreement with the contents of its Warranty Conditions, Jacuzzi Europe S.p.A. guarantees for the period stated by the norms in force in the individual countries of the European Union, the absence of defects in conformity for their appliances, provided that they are used for non-commercial and non-professional purposes by the final consumer (private consumer).

In countries that are not part of the European Union the guarantee and consequential intervention that are necessary to eliminate any defects in conformity of appliances will be the entire and final responsibility of the purchaser (retailer), who will have to organize technical assistance, unless other written agreements are made with Jacuzzi Europe S.p.A.

12.2. The guarantee is valid only if installation of the appliance is carried out strictly in accordance with the instructions and requirements stated in the Jacuzzi Europe S.p.A. documentation. If it is installed in a way that does not guarantee total and easy access (for example, surrounding it by a wall), the purchaser (if responsible) or the final consumer, or whoever is responsible on their behalf, will be liable for any removal, re-positioning and related expenses. The guarantee is no longer valid if components or other parts of the appliance are altered from the original state at the time of supply.

12.3. Total or partial replacement of the appliance, (even with similar products), will not be carried out if considered impossible, or if this should entail unreasonable expense for Jacuzzi Europe S.p.A. in comparison with repair, also taking into account costs related to replacement of the appliance and the inconvenience caused for the final consumer.

12.4. The guarantee is not valid if there is non-compliance due to causes that are not attributable to Jacuzzi Europe S.p.A. For example: bad or careless maintenance of the appliance or its alteration or modification, different use to that stated in the instruction manual, the use of non-original spare parts, damage during transport that is not notified as required by law or caused by unauthorized freight carriers, inefficiency or non-conformity of the electric or water supply systems, lightning and exceptional atmospheric events, or any type of anomaly that is not due to defects in the conformity of the appliance.

12.5. The Jacuzzi Europe S.p.A. network of technical service centres is authorized by the purchaser (retailer) to make the guarantee valid for the final consumer, even if the request comes from the consumer himself or from any intermediaries. It must be clearly understood that the retailer is directly responsible towards the final consumer, as provided by law. The guarantee is not valid if the final consumer, or whoever on his behalf, does not allow any reasonable check of conformity and functionality of the appliance, or if the products replaced under guarantee are not returned to Jacuzzi Europe S.p.A.

12.6. The following are not covered by the guarantee: damage due to an appliance being left in disuse, missing profit and any type of indirect or accruing damage, damage caused by the use of accessories that are not Jacuzzi Europe S.p.A. original parts and the parts subject to normal wear and tear.

12.7. The services carried out in compliance with the obligations provided by this guarantee do not extend beyond the period of original guarantee, except where this is provided for by statutory national regulations. In any case the statutory rights of the final consumer are safeguarded.

12.8. The guarantee is null and void when the purchaser (retailer) keeps the appliances in stock for more than 24 months. Jacuzzi Europe S.p.A. reserves the right to request reimbursement from the purchaser (retailer), for any services owed and returns under guarantee for the final consumer regarding these appliances, with the entire charge of every and any related expense.

Art. 13 Return of goods

13.1. The return of any materials must be previously authorized by Jacuzzi Europe S.p.A. in writing. Only products with their original packaging can be returned which have not yet been used, and whose model is still being produced and that were delivered not more than 12 months ago.

13.2. Products, which are not in the catalogue, that have been made according to specifications from the purchaser (retailer) will not be returned.

13.3. The cost of returning goods, to be borne by the purchaser (retailer) who will be charged for re-storage, will be a sum not exceeding 25% of the value of the returned goods.

Art. 14 Interpretation – Modifications

14.1. Any reference to Jacuzzi Europe S.p.A. price lists, general terms or other materials refers to the documents in force at the time of the same reference, unless otherwise specified.

14.2. Except for cases provided for under the current general terms, any modification carried out by parties to the contracts to which the current general terms apply must be in writing, or will be null and void. The exception to one or more provisions of the current general terms must not be interpreted extensively, or by analogy, and does not mean the general terms, as a whole, will cease to apply.

Art. 15 Controversies

15.1. For any controversy related, or connected, to the contracts to which the current terms are applied the Court of Pordenone has exclusive jurisdiction, also in the event of payment being agreed by means of bills of exchange.

The data and characteristics indicated are not binding for Jacuzzi Europe Spa, who has the right to modify them without prior notice.

CONDIZIONI GENERALI DI VENDITA

Le presenti condizioni di vendita annullano e sostituiscono tutte le precedenti

Art. 1 Disposizioni Generali

1.1. Le presenti condizioni generali, salvo eventuali deroghe specificatamente concordate per iscritto, disciplinano tutti gli attuali e futuri contratti di vendita tra le parti.

Art. 2 Formazione ed oggetto del contratto

2.1. Ogni ordine impegna Jacuzzi Europe S.p.A. solo dopo la sua accettazione scritta. L'accettazione dell'ordine da parte di Jacuzzi Europe S.p.A. può consistere anche nella sua esecuzione.

Art. 3 Consegna

3.1. Salva diversa pattuizione scritta, la resa s'intende "franco destino" con addebito del trasporto in fattura. Jacuzzi Europe S.p.A. avrà la facoltà di incaricare del trasporto un vettore di sua fiducia.

Nei casi di ritardato ritiro della merce l'acquirente (rivenditore) sarà tenuto al pagamento delle spese di giacenza.

3.2. I termini concordati per la consegna s'intendono indicativi. In caso di ritardi, l'acquirente (rivenditore) non potrà pertanto avanzare alcuna richiesta di risarcimento danni.

Art. 4 Imballi

4.1. Gli imballi delle apparecchiature sono conformi alle normative internazionali per trasporti effettuati via terra su automezzi. Imballi diversi dallo standard comporteranno una maggiorazione del prezzo da concordare all'ordine.

Art. 5 Annullamento ordini

5.1. L'ordine dell'acquirente (rivenditore) costituisce proposta ferma d'acquisto. Nessun ordine può essere annullato senza il consenso scritto di Jacuzzi Europe S.p.A. In caso di annullamento degli ordini, Jacuzzi Europe S.p.A. si riserva anche la facoltà di richiedere il risarcimento del danno.

Art. 6 Progettazione - Dati Tecnici

6.1. Jacuzzi Europe S.p.A. si riserva il diritto di cessare senza preavviso la fabbricazione di qualsiasi modello e/o di introdurre modifiche ai modelli in produzione, senza per questo essere obbligata ad effettuare tali modifiche sui prodotti venduti in precedenza.

6.2. I dati e le caratteristiche contenuti nella documentazione tecnica e pubblicitaria di Jacuzzi Europe S.p.A. (cataloghi, manuali, depliant pubblicitari, illustrazioni, listini prezzi), sono soggetti a modifiche e non vincolanti.

Art. 7 Prezzi

7.1. I prezzi, I.V.A. esclusa, sono quelli riportati sui listini vigenti al momento dell'ordine e s'intendono per merce con resa "franco destino" con addebito del trasporto in fattura, salvo diversa pattuizione.

7.2. I prezzi, le quotazioni e gli sconti sono suscettibili di variazione senza obbligo di preavviso da parte di Jacuzzi Europe S.p.A.

7.3. Tutti gli ordini ricevuti dopo l'avvenuta modifica dei listini, nonché le spedizioni programmate oltre i trenta giorni dalla comunicazione della variazione, sono soggetti ai nuovi prezzi.

Art. 8 Pagamento

8.1. Il pagamento della merce s'intende validamente eseguito solamente all'avvenuto accredito, a Jacuzzi Europe S.p.A., delle relative somme.

8.2. Qualsiasi ritardo o irregolarità nel pagamento dà a Jacuzzi Europe S.p.A. il diritto di sospendere le forniture o di risolvere i contratti in corso, anche se non relativi ai pagamenti in questione, nonché il diritto al risarcimento degli eventuali danni (compresi quelli da svalutazione della moneta).

Jacuzzi Europe S.p.A. ha in ogni caso il diritto – a decorrere dalla scadenza del pagamento, senza necessità di messa in mora – agli interessi legali, maggiorati di 5 (cinque) punti.

8.3. L'acquirente (rivenditore) è tenuto al pagamento integrale anche in caso di contestazione o controversia. Non è ammessa compensazione con eventuali crediti vantati nei confronti di Jacuzzi Europe S.p.A., salvo autorizzazione scritta.

8.4. In caso di mancato pagamento, anche solo parziale, Jacuzzi Europe S.p.A. ha la facoltà – a sua discrezione – di richiedere all'acquirente (rivenditore) il pagamento dell'intero importo del contratto ovvero di dichiarare risolto il contratto, con il diritto di ottenere la restituzione dei prodotti consegnati e di trattenere, a titolo di risarcimento danni, le somme sino a quel momento incassate, salva ogni altra azione per il maggior danno.

Art. 9 Riserva di proprietà

9.1. Nel caso in cui il pagamento debba essere effettuato – in tutto o in parte – dopo la consegna, i prodotti consegnati restano di proprietà di Jacuzzi Europe S.p.A. sino al momento dell'integrale pagamento del prezzo, secondo quanto disposto dall'art. 1523 del Codice Civile.

9.2. In forza della predetta riserva di proprietà, Jacuzzi Europe S.p.A. avrà il diritto di procedere al recupero di eventuale merce impagata: in tal caso saranno a carico dell'acquirente (rivenditore) tutti i costi relativi e Jacuzzi Europe S.p.A. potrà trattenere eventuali somme già incassate a titolo di risarcimento del danno. Qualora l'acquirente (rivenditore) dovesse aver rivenduto tale merce a terzi, i diritti vantati da Jacuzzi Europe S.p.A., in forza della presente clausola, si trasferiranno sul prezzo ricavato dalla vendita della merce stessa.

Art. 10 Forza maggiore ed eccessiva onerosità

10.1. Costituiscano ipotesi di cause d'esonero da responsabilità eventi quali incendi, crolli, inondazioni, mancanza di rifornimenti, difficoltà di trasporti, scioperi, serrate o altri eventi dovuti a cause di forza maggiore, che impediscano o riducano sensibilmente la produzione di Jacuzzi Europe S.p.A. o dei fornitori di questa, od ostacolino gravemente il trasporto della merce venduta.

La risoluzione del contratto, come pure l'esercizio degli altri rimedi diversi dalla richiesta di risarcimento danno, sono ammessi solo per impedimenti che si protraggano per almeno 60 giorni.

10.2. Se, prima della loro esecuzione, l'adempimento degli obblighi di Jacuzzi Europe S.p.A. sia divenuto – per qualsiasi motivo imprevedibile da un imprenditore del settore con normale esperienza – eccessivamente oneroso in rapporto alla controprestazione originaria pattuita – così da modificare il rapporto stesso in misura pari o superiore al 20% – Jacuzzi Europe S.p.A. potrà chiedere una revisione delle condizioni contrattuali o, in mancanza d'accordo, dichiarare risolto il contratto.

Art. 11 Reclami

11.1. L'acquirente (rivenditore) è tenuto a denunciare eventuali danni al prodotto, o difformità di consegna, che potrebbero essere rilevati non appena in possesso della merce – per iscritto e dettagliatamente a pena di nullità – entro e non oltre 8 giorni dal momento in cui la merce gli è stata messa a disposizione.

11.2. Eventuali difetti di conformità non individuabili a seguito della verifica della merce di cui al paragrafo 11.1., dovranno essere denunciati dall'acquirente, a pena di decadenza, non oltre i termini previsti dalla legge, che decorrono dal momento in cui la merce stessa gli è stata messa a disposizione.

Art. 12 Garanzia

12.1. In accordo con quanto contenuto nelle proprie Condizioni di Garanzia, Jacuzzi Europe S.p.A. garantisce per il periodo previsto dalle normative vigenti nei singoli Paesi dell'Unione Europea, l'assenza di difetti di conformità delle proprie apparecchiature, purché utilizzate per scopi estranei ad eventuali attività imprenditoriali o professionali svolte dall'utilizzatore finale (consumatore privato).

Nei Paesi che non fanno parte dell'Unione Europea, l'onere della garanzia e dei conseguenti interventi necessari per eliminare eventuali difetti di conformità delle apparecchiature, sarà a totale e definitivo carico dell'acquirente (rivenditore), che dovrà pertanto costituire una propria organizzazione di assistenza tecnica, salvo diversi accordi scritti con Jacuzzi Europe S.p.A.

12.2. La garanzia è valida solo se l'installazione dell'apparecchiatura viene eseguita rispettando scrupolosamente le indicazioni e le prescrizioni contenute nella documentazione di Jacuzzi Europe S.p.A. Qualora essa venga installata in modo tale da non garantirne la piena ed agevole accessibilità (ad esempio, murandola) l'acquirente (se di ciò responsabile), ovvero l'utilizzatore finale o chi per loro, dovrà farsi carico della sua eventuale rimozione, ricollocazione e delle spese conseguenti. La garanzia decade qualora vengano modificati componenti, o altre parti dell'apparecchiatura, rispetto alle condizioni originarie di fornitura.

12.3. La sostituzione dell'apparecchiatura, totale o parziale (anche con prodotti similari), non potrà essere effettuata qualora oggettivamente impossibile, ovvero qualora dovesse comportare per Jacuzzi Europe S.p.A. spese irragionevoli rispetto alla riparazione, tenuto anche conto delle spese connesse alla sostituzione stessa e degli inconvenienti arrecabili all'utilizzatore finale.

12.4. La garanzia è esclusa per vizi di conformità derivanti da cause non imputabili a Jacuzzi Europe S.p.A., quali ad esempio: cattiva o carente manutenzione dell'apparecchiatura ovvero sua alterazione o modifica, utilizzo difforme a quanto riportato nel libretto di uso e manutenzione, utilizzo di ricambi non originali, danni da trasporto non contestati entro i termini di legge ovvero causati da trasportatori non autorizzati, inefficienze o anomalie degli impianti elettrici e idrici, fulmini ed eventi atmosferici eccezionali, anomalie di ogni genere non riconducibili a difetti di conformità dell'apparecchiatura.

12.5. La rete dei Centri assistenza di Jacuzzi Europe S.p.A. è autorizzata dall'acquirente (rivenditore) a prestare la garanzia nei confronti dell'utilizzatore finale, anche se la richiesta perviene dall'utilizzatore stesso o da eventuali intermediari. Resta comunque inteso che il responsabile diretto nei confronti dell'utilizzatore finale è il rivenditore, come previsto dalla legge. La garanzia decade qualora l'utilizzatore finale, o chi per lui, non consenta ogni ragionevole verifica di conformità e/o funzionalità dell'apparecchiatura, ovvero non vengano resi a Jacuzzi Europe S.p.A. i prodotti sostituiti in garanzia.

12.6. Non sono coperti dalla garanzia: i danni da mancato utilizzo dell'apparecchiatura, il lucro cessante e i danni di ogni genere indiretti e consequenziali, i danni causati dall'utilizzo di accessori non originali Jacuzzi Europe S.p.A., le parti soggette a normale usura.

12.7. Le prestazioni effettuate in ottemperanza agli obblighi previsti dalla garanzia non estendono il periodo di garanzia originario, salvo che ciò sia previsto da norme di legge nazionali inderogabili. Sono in ogni caso fatti salvi i diritti inderogabili di legge dell'utilizzatore finale.

12.8. Pena la decadenza della garanzia, all'acquirente (rivenditore) non è consentito stoccare le apparecchiature per più di 24 mesi. Jacuzzi Europe S.p.A. si riserva la facoltà di esercitare il diritto di rivalsa nei confronti dell'acquirente (rivenditore), per eventuali prestazioni dovute e rese in garanzia all'utilizzatore finale su tali apparecchiature, con integrale addebito di ogni e qualsiasi onere ad esse relativo.

Art. 13 Restituzione della merce

13.1. La restituzione di qualsiasi materiale deve essere preventivamente autorizzata da Jacuzzi Europe S.p.A. per iscritto. Potranno essere restituiti solo i prodotti provvisti del loro imballo originale, non ancora usati, il cui modello sia ancora in produzione e che siano stati consegnati da non più di 12 mesi.

13.2. I prodotti non a catalogo, realizzati su specifica richiesta dell'acquirente (rivenditore), non potranno essere restituiti.

13.3. Le spese di restituzione dei prodotti gravano sull'acquirente (rivenditore), cui potrà essere addebitato, a titolo di ristoccaggio, un importo non eccedente il 25% del valore del materiale restituito.

Art. 14 Interpretazione - Modifiche

14.1. Ogni richiamo ai listini prezzi, condizioni generali od altro materiale di Jacuzzi Europe S.p.A. s'intende riferito ai documenti in vigore al momento del richiamo stesso, salvo non sia diversamente specificato.

14.2. Salvi i casi previsti dalle presenti condizioni generali, ogni modifica fatta dalle parti ai contratti cui si applicano le presenti condizioni generali dovrà essere effettuata per iscritto, a pena di nullità. La deroga ad una o più disposizioni delle presenti condizioni generali non deve interpretarsi estensivamente, o per analogia, e non implica la volontà di disapplicare le condizioni generali nel loro insieme.

Art. 15 Controversie















15.1. Per ogni controversia relativa, o comunque collegata, ai contratti cui si applicano le presenti condizioni è esclusivamente competente il Foro di Pordenone, anche nel caso in cui sia pattuito il pagamento a mezzo effetti cambiari.

I dati e le caratteristiche indicate non impegnano la Jacuzzi Europe Spa, che si riserva il diritto di apportare tutte le modifiche ritenute opportune senza obbligo di preavviso o sostituzione.

SEATS • SEDUTE

Number of seats Numero sedute * Lounge	x 2	x 3	x 4	x 5	x 5-6	x 6-7	x 8-9
THE J-500™ LUXURY COLLECTION					J-585™ J-575™*		
THE J-400™ DESIGNER COLLECTION		J-415™*		J-435™ J-435™	J-480™* J-445™*		J-495™
THE J-LX® ENERGY EFFICIENT COLLECTION					J-LXL*		
THE J-300™ COMFORT COLLECTION		J-315™*		J-335™* J-325™	J-375™* J-355™* J-345™	J-385™ J-365™	
THE DESIGN COLLECTION	Flow* City Spa*	Unique*	Delos* Delfi* Oxia	Santorini Pro*	Alimia Profile*	Virtus™	
THE PROFESSIONAL COLLECTION		Lodge S*		Lodge M	Enjoy* Profile Pro* Lodge L*	Virginia Ex.* Alimia Ex. Virtus Pro	Sienna Ex.

ICONS • ICONE

 Built-in	 External corner lighting Illuminazione esterna angolare
 Freestanding	 Corona Ozone kit Kit Ozono Corona
 Insulating cover Copertura termica	 - CLEARRAY® - CLEARRAY® PRO ₃ TECT™
 Number of seats Numero sedute	 Heat Management System Sistema di gestione del calore
 Lounge	 LCD control panel Pannello comandi LCD
 Whirlpool jets Bocchette idromassaggio	 LED control panel Pannello comandi LED
 Blowers	 ProTouch™ control panel Pannello di controllo ProTouch™
 Water Rainbow Cascade Cascata Water Rainbow	 Remote control Telecomando
 Standard packing Imballo standard	 Water monitoring system Sistema di monitoraggio acqua
 Packing for container Imballo per container	 ProLink™ integrated Wi-Fi ProLink™ Wi-Fi integrato
 Headrest Poggiatesta	 - Italian Design Audio System - Insound System - Bluewave™ Stereo System
 HydroSoothe™ pillow Cuscino HydroSoothe™	 Without radio Senza radio
 Soft pillow headrest Poggiatesta morbido	 Quick Drain Quick Drain (scarico veloce)
 Cushion Cuscino	 Smart Access Door Pannello "Smart Access"
 Underwater spotlight Illuminazione subacquea	 Automatic water fill-up Rabbocco acqua automatico
 ProEdge™ interior lighting Illuminazione interna ProEdge™	 Aromatherapy Aromaterapia



JACUZZI® EUROPE S.p.A.

Direzione e Coordinamento
Jacuzzi Brands, LLC. (USA)
S.S. Pontebbana Km 97,200
33098 Valvasone Arzene (PN) Italia
Tel. +39-0434-859111
Fax +39-0434-85278

Via Copernico 38
20125 MILANO
Tel. +39-02-8725 9325
www.jacuzzi.it
www.jacuzzi.eu
info@jacuzzi.eu